

THE EXPERT'S VOICE® IN OPEN SOURCE

Pro  
**Freeware** and  
**Open Source**  
**Solutions** for  
**Business**

Phillip Whitt

*AN INTRODUCTION TO MONEY-SAVING,  
OPEN SOURCE SOFTWARE ALTERNATIVES  
FOR BUSINESSES*

EXTRAS ONLINE

**Apress**®

# Pro Freeware and Open Source Solutions for Business



Phillip Whitt

Apress®

## ***Pro Freeware and Open Source Solutions for Business***

Phillip Whitt  
Winkfield Place  
Columbus, GA, USA

ISBN-13 (pbk): 978-1-4842-1131-1  
DOI 10.1007/978-1-4842-1130-4

ISBN-13 (electronic): 978-1-4842-1130-4

Library of Congress Control Number: 2015950196

Copyright © 2015 by Phillip Whitt

This work is subject to copyright. All rights are reserved by the Publisher, whether the whole or part of the material is concerned, specifically the rights of translation, reprinting, reuse of illustrations, recitation, broadcasting, reproduction on microfilms or in any other physical way, and transmission or information storage and retrieval, electronic adaptation, computer software, or by similar or dissimilar methodology now known or hereafter developed. Exempted from this legal reservation are brief excerpts in connection with reviews or scholarly analysis or material supplied specifically for the purpose of being entered and executed on a computer system, for exclusive use by the purchaser of the work. Duplication of this publication or parts thereof is permitted only under the provisions of the Copyright Law of the Publisher's location, in its current version, and permission for use must always be obtained from Springer. Permissions for use may be obtained through RightsLink at the Copyright Clearance Center. Violations are liable to prosecution under the respective Copyright Law.

Trademarked names, logos, and images may appear in this book. Rather than use a trademark symbol with every occurrence of a trademarked name, logo, or image we use the names, logos, and images only in an editorial fashion and to the benefit of the trademark owner, with no intention of infringement of the trademark.

The use in this publication of trade names, trademarks, service marks, and similar terms, even if they are not identified as such, is not to be taken as an expression of opinion as to whether or not they are subject to proprietary rights.

Audacity® software is copyright © 1999-2015 Audacity Team. [website: <http://audacityteam.org/>. It is free software distributed under the terms of the GNU General Public License.] The name Audacity® is a registered trademark of Dominic Mazzoni. Images used with permission.

While the advice and information in this book are believed to be true and accurate at the date of publication, neither the authors nor the editors nor the publisher can accept any legal responsibility for any errors or omissions that may be made. The publisher makes no warranty, express or implied, with respect to the material contained herein.

Managing Director: Welmoed Spahr  
Lead Editor: Louise Corrigan  
Development Editor: James Markham  
Technical Reviewer: Massimo Nardone  
Editorial Board: Steve Anglin, Mark Beckner, Gary Cornell, Louise Corrigan, Jim DeWolf, Jonathan Gennick,  
Jonathan Hassell, Robert Hutchinson, Michelle Lowman, James Markham, Susan McDermott,  
Matthew Moodie, Jeffrey Pepper, Douglas Pundick, Ben Renow-Clarke, Gwenan Spearing,  
Matt Wade, Steve Weiss  
Coordinating Editor: Melissa Maldonado  
Copy Editor: Mary Behr  
Compositor: SPi Global  
Indexer: SPi Global  
Artist: SPi Global

Distributed to the book trade worldwide by Springer Science+Business Media New York, 233 Spring Street, 6th Floor, New York, NY 10013. Phone 1-800-SPRINGER, fax (201) 348-4505, e-mail [orders-ny@springer-sbm.com](mailto:orders-ny@springer-sbm.com), or visit [www.springeronline.com](http://www.springeronline.com). Apress Media, LLC is a California LLC and the sole member (owner) is Springer Science + Business Media Finance Inc (SSBM Finance Inc). SSBM Finance Inc is a Delaware corporation.

For information on translations, please e-mail [rights@apress.com](mailto:rights@apress.com), or visit [www.apress.com](http://www.apress.com).

Apress and friends of ED books may be purchased in bulk for academic, corporate, or promotional use. eBook versions and licenses are also available for most titles. For more information, reference our Special Bulk Sales-eBook Licensing web page at [www.apress.com/bulk-sales](http://www.apress.com/bulk-sales).

Any source code or other supplementary material referenced by the author in this text is available to readers at [www.apress.com](http://www.apress.com). For additional information about how to locate and download your book's source code, go to [www.apress.com/source-code/](http://www.apress.com/source-code/). Readers can also access source code at SpringerLink in the Supplementary Material section for each chapter.

Printed on acid-free paper

*This book is dedicated to my lovely wife and wonderful daughter. Their support and patience while I was writing this book over the past several months will forever be appreciated.*

# Contents at a Glance

<b>About the Author .....</b>	<b>xvii</b>
<b>About the Technical Reviewer .....</b>	<b>xix</b>
<b>Acknowledgments .....</b>	<b>xxi</b>
<b>Introduction .....</b>	<b>xxiii</b>
<b>■ Chapter 1: Office Productivity, Note Taking, Accounting, and PDF Creation.....</b>	<b>1</b>
<b>■ Chapter 2: Point-of-Sale, CRM, Backup, and Compression Software .....</b>	<b>31</b>
<b>■ Chapter 3: Desktop Publishing, Illustration, Painting, and 3D Modeling Software .....</b>	<b>59</b>
<b>■ Chapter 4: Photo Editing Software .....</b>	<b>87</b>
<b>■ Chapter 5: Audio-Video Capture, Conversion, and Editing Software .....</b>	<b>119</b>
<b>■ Chapter 6: Project Planning, Inventory Management, and Time Tracking Software.....</b>	<b>143</b>
<b>■ Chapter 7: Website Creation Software and Web Browsers.....</b>	<b>169</b>
<b>■ Chapter 8: Content Management Solutions .....</b>	<b>181</b>
<b>■ Chapter 9: Network and Security Utilities .....</b>	<b>189</b>
<b>■ Chapter 10: Linux: The Free Alternative to Windows and Mac OS.....</b>	<b>201</b>
<b>■ Appendix A: Professional Profiles .....</b>	<b>229</b>
<b>■ Appendix B: Additional Software Products.....</b>	<b>235</b>
<b>■ Appendix C: Resources for Free and Open Source Software .....</b>	<b>243</b>
<b>Index.....</b>	<b>245</b>

# Contents

<b>About the Author .....</b>	<b>xvii</b>
<b>About the Technical Reviewer .....</b>	<b>xix</b>
<b>Acknowledgments .....</b>	<b>xxi</b>
<b>Introduction .....</b>	<b>xxiii</b>
<b>■ Chapter 1: Office Productivity, Note Taking, Accounting, and PDF Creation .....</b>	<b>1</b>
AbiWord: Simplicity in Word Processing .....	1
Feature Highlights .....	3
AbiWord Support .....	4
LibreOffice: The Powerful Free Office Suite .....	5
LibreOffice Modules .....	5
Writer .....	6
Calc .....	7
Impress .....	9
Base .....	10
Draw .....	11
LibreOffice Support .....	12
Zim: Open Source Note-Taking Application .....	13
Zim Support .....	15
Google Keep: Create, Sync, and Share Notes .....	15
Feature Highlights .....	16
Google Keep Support .....	17

<b>GnuCash: Open Source Accounting Software.....</b>	<b>18</b>
Feature Highlights .....	20
GnuCash Support.....	20
<b>Manager: Free Small Business Accounting Software.....</b>	<b>21</b>
Manager Support.....	25
<b>PDF reDirect: Basic PDF Creation Freeware .....</b>	<b>26</b>
Feature Highlights .....	27
PDF reDirect Support.....	28
<b>Summary .....</b>	<b>29</b>
<b>■ Chapter 2: Point-of-Sale, CRM, Backup, and Compression Software .....</b>	<b>31</b>
<b>Imonggo (Free Version): A Point-of-Sale Utility for The Small Shop or Boutique.....</b>	<b>31</b>
Feature Highlights .....	32
Imonggo Support .....	35
<b>POS/Cash Register: Turn Your Old PC Into a Cash Register .....</b>	<b>35</b>
Feature Highlights .....	36
POS/Cash Register Support.....	38
<b>Insightly: A Free, Easy-to-Use CRM Application.....</b>	<b>39</b>
Feature Highlights .....	40
Insightly Support .....	42
<b>Bitrix24: A Social Intranet, CRM Solution For Small Business .....</b>	<b>43</b>
Feature Highlights .....	43
Bitrix24 Support.....	47
<b>FBackup: A Free Basic Backup Utility.....</b>	<b>48</b>
Feature Highlights .....	49
FBackup Support.....	52
<b>7Zip: An Open Source Alternative to WinZip .....</b>	<b>52</b>
Feature Highlights .....	53
7Zip Support .....	56
<b>Summary.....</b>	<b>57</b>

■ **Chapter 3: Desktop Publishing, Illustration, Painting, and 3D Modeling Software** ..... **59**

**Serif PagePlus Starter Edition: A Free, Easy-to-Use Desktop Publishing Program**..... **60**

        Feature Highlights ..... 60

        Design Capabilities ..... 60

        PagePlus SE Support ..... 62

**Scribus: The Powerful, Professional, Open Source Desktop Publishing Program** ..... **63**

        Feature Highlights ..... 64

        Design Capabilities ..... 64

        Scribus Support ..... 65

**Serif DrawPlus Starter Edition: A Free, Basic, Vector Graphics Drawing Program**..... **66**

        Feature Highlights ..... 67

        Graphics Creation ..... 67

        DrawPlus SE Support..... 68

**Inkscape: Pro-Quality Open Source Vector Drawing Software** ..... **68**

        Feature Highlights ..... 70

        Graphics Creation ..... 70

        Inkscape Support..... 72

**Krita: The Powerful Open Source Digital Drawing and Painting Program** ..... **73**

        Feature Highlights ..... 74

        Document Creation ..... 74

        Brush Presets ..... 75

        Krita Support ..... 76

**FreeCAD: Open Source Parametric 3D Modeling Software** ..... **77**

        Feature Highlights ..... 79

        Drafting Capabilities ..... 80

        FreeCAD Support ..... 81

<b>Blender: The Ultimate Open Source 3D Creation Software.....</b>	<b>81</b>
Feature Highlights .....	82
Rendering Capabilities.....	83
Blender Support.....	84
<b>Summary.....</b>	<b>84</b>
<b>■ Chapter 4: Photo Editing Software .....</b>	<b>87</b>
<b>PhotoScape: An Easy-to-Use Photo Editor for Beginners.....</b>	<b>88</b>
Feature Highlights .....	88
Tools .....	89
Filters.....	90
Objects.....	91
PhotoScape Support.....	92
<b>Paint.NET: Basic Image Editing for Windows.....</b>	<b>93</b>
Feature Highlights .....	94
Editing Capabilities .....	95
Graphics Creation .....	99
Paint.NET Support.....	100
<b>GIMP: The Premier Open Source Image Editor .....</b>	<b>100</b>
Feature Highlights .....	101
Editing Capabilities .....	102
Graphics Creation .....	105
GIMP Support.....	105
<b>Autodesk Pixlr: Web-Based and Mobile Device Photo Editing.....</b>	<b>107</b>
Pixlr Editor .....	107
Feature Highlights .....	108
Pixlr Express .....	108
Feature Highlights .....	109
Pixlr O-Matic.....	109
Pixlr Support.....	110

UFRaw: Open Source RAW Image Editing.....	110
Feature Highlights .....	111
UFRaw Support .....	113
FotoSketcher: Automatically Turn Photos into Digital Art .....	113
Feature Highlights .....	114
Editing Capabilities .....	115
FotoSketcher Support.....	117
Summary.....	118
<b>■ Chapter 5: Audio-Video Capture, Conversion, and Editing Software .....</b>	<b>119</b>
fre:ac (Free Audio Converter): An Open Source Audio CD Ripping Program .....	119
Feature Highlights .....	120
fre:ac Support.....	122
Audacity®: A Powerful, Open Source Audio Editor.....	122
Feature Highlights .....	123
Editing Capabilities.....	124
Audacity Support .....	126
MPEG Streamclip: A Handy, Free Video Conversion Tool.....	127
Feature Highlights .....	128
Editing Capabilities.....	129
MPEG Streamclip Support .....	129
Windows Movie Maker: The Free Microsoft Video Editing Tool .....	130
Feature Highlights .....	130
Editing Capabilities.....	130
Windows Movie Maker Support.....	132
VirtualDub: Open Source Video Processing for Windows .....	132
Feature Highlights .....	133
Editing Capabilities.....	134
VirtualDub Support .....	135

Kdenlive: The Open Source Video Editor for Linux and Mac OS .....	136
Feature Highlights .....	137
Editing Capabilities.....	137
Kdenlive Support .....	140
Summary .....	141
<b>■ Chapter 6: Project Planning, Inventory Management, and Time Tracking Software.....</b>	<b>143</b>
ProjectLibre: An Open Source Alternative to Microsoft Project .....	144
Feature Highlights .....	144
ProjectLibre Support.....	147
Ganttter: A Free Web-Based Project Management Solution .....	148
Feature Highlights .....	148
Ganttter Support .....	152
FreeHR: Free Web-Based Human Resource Software .....	153
Feature Highlights .....	154
FreeHR Support .....	157
ABC (Always Better Control) Inventory: A Free Option For the Small- and Mid-Sized Business.....	158
Feature Highlights .....	159
ABC Inventory Support.....	161
My Hours: A Free, Web-Based Time Tracking Tool for the Solo Freelancer.....	162
Feature Highlights .....	163
My Hours Support.....	166
Summary.....	167
<b>■ Chapter 7: Website Creation Software and Web Browsers .....</b>	<b>169</b>
WordPress: Free, Open-Source Tool and Content Management System .....	169
Feature Highlights .....	170
Multi-User and Multi-Blogging .....	171
WordPress Support.....	171

KompoZer for Easy Web Authoring .....	171
Feature Highlights .....	173
KompoZer Support.....	174
BlueGriffon: A New WYSIWYG Content Editor for the Web .....	175
Feature Highlights .....	176
BlueGriffon Support.....	177
Chromium: Where Google Chrome Gets Its Code .....	177
Feature Highlights .....	178
Firefox: The Open Source Browser That Respects Privacy.....	178
Feature Highlights .....	180
Summary.....	180
<b>■ Chapter 8: Content Management Solutions .....</b>	<b>181</b>
Drupal: An Open Source, Community-Based Alternative .....	181
Feature Highlights .....	182
concrete5: An Open Source Content Management System.....	183
Feature Highlights .....	183
concrete5 Support.....	185
GetSimple CMS: A Simple, Open Source Content Management System .....	186
Feature Highlights .....	186
GetSimpleCMS Support.....	188
Summary.....	188
<b>■ Chapter 9: Network and Security Utilities .....</b>	<b>189</b>
Nmap: A Free and Open Source Utility for Network Discovery/Security Auditing.....	189
Feature Highlights .....	190
Nmap Support.....	191
Keepass: A Free and Open-Source Password Manager .....	191
Feature Highlights .....	192
Keepass Support .....	193

tcpdump: A Powerful Command Line Packet Analyzer .....	194
Feature Highlights .....	194
tcpdump Support.....	194
<b>Avira: Powerful, Free Antivirus Protection for Personal PCs and Macs.....</b>	<b>195</b>
Feature Highlights .....	196
Avira Support.....	196
<b>ClamAV: An Open Source Cross-Platform (Including Linux) Antivirus Program .....</b>	<b>196</b>
Feature Highlights .....	197
ClamAV Support.....	198
<b>Open Whisper Systems: Open Source Security for Mobile Devices .....</b>	<b>198</b>
Open Whisper Systems Support .....	199
<b>Summary.....</b>	<b>199</b>
<b>■ Chapter 10: Linux: The Free Alternative to Windows and Mac OS.....</b>	<b>201</b>
What Is Linux?.....	201
A Brief History of Linux.....	206
The Advantages of Using Linux .....	206
<b>Ubuntu: Powering Millions of Laptops and Desktop Computers Around the World .....</b>	<b>208</b>
Ease of Use.....	208
Ubuntu Dashboard and Desktop .....	209
Downloading and Installing Ubuntu.....	210
Ubuntu Software and Software Center .....	212
Running Windows Applications on WINE .....	214
Security .....	214
Accessory Compatibility .....	216
Ubuntu Support.....	217
<b>Zorin OS: Especially for Newcomers to Linus.....</b>	<b>217</b>
The Look Changer.....	218
Downloading and Installing Zorin OS.....	219
Zorin OS Support .....	221

Linux Mint: A Modern, Elegant Operating System .....	222
Downloading and Installing Linux Mint.....	225
Linux Mint Support .....	226
Summary.....	227
■ <b>Appendix A: Professional Profiles .....</b>	<b>229</b>
Patrick David .....	229
Steve Czajka.....	231
■ <b>Appendix B: Additional Software Products.....</b>	<b>235</b>
Office Productivity, Note Taking, Accounting, and PDF Creation .....	235
Jarte .....	235
NeoOffice .....	235
KeepNote .....	236
RedNotebook .....	236
TurboCASH.....	236
Buddi .....	237
CutePDF Writer .....	237
Point of Sale, CRM, Backup, and Compression Software .....	237
Regit® Express Point of Sale for Windows .....	237
SuiteCRM .....	238
Areca Backup .....	238
PeaZip.....	238
Illustration, Painting, 3D Modeling Software, and Photo Editing .....	239
Draw SVG.....	239
Sumo Paint .....	239
K-3D.....	239
Photo POS.....	239
Darktable .....	240

■ CONTENTS

<b>Audio-Video Software.....</b>	<b>240</b>
Audiograbber .....	240
Avidemux .....	241
<b>Project Management.....</b>	<b>241</b>
Redmine .....	241
<b>■ Appendix C: Resources for Free and Open Source Software .....</b>	<b>243</b>
<b>Index.....</b>	<b>245</b>

# About the Author



**Phillip Whitt** is an author and small business owner. His professional experience spans more than three decades. Many of those years were spent in marketing and advertising managerial roles in the retail building materials business. Since 2000, Mr. Whitt has owned and operated a film-to-video and image editing/design business. Over the years, he's learned that budgeting is an important factor that helps contribute to the bottom line of any business.

Phillip Whitt the author of *Beginning Photo Retouching and Restoration Using GIMP* (Apress Publishing). He is trained and certified in the use of a number of open source software programs such as OpenOffice, GIMP, Inkscape, Scribus, and Ubuntu Linux.

# About the Technical Reviewer



**Massimo Nardone** holds a Master of Science degree in Computing Science from the University of Salerno, Italy. He worked as a PCI QSA and Senior Lead IT Security/Cloud/SCADA Architect for many years and currently works as Security, Cloud, and SCADA Lead IT Architect for Hewlett Packard Finland. He has more than 20 years of work experience in IT including security, SCADA, cloud computing, IT infrastructure, mobile, security, and WWW technology areas for both national and international projects. Massimo has worked as a Project Manager, Cloud/SCADA Lead IT Architect, Software Engineer, Research Engineer, Chief Security Architect, and Software Specialist. He worked as visiting lecturer and supervisor for exercises at the Networking Laboratory of the Helsinki University of Technology (Aalto University). He has been programming and teaching how to program with Perl, PHP, Java, VB, Python, C/C++, and MySQL for more than 20 years. He is the author of *Pro Android Games* (Apress, 2015).

He holds four international patents (PKI, SIP, SAML, and Proxy areas). This book is dedicated to Pia, Luna, Leo, e Neve, who are the beautiful reasons of his life.

# Acknowledgments

I would like to thank the team at Apress, especially Louise Corrigan, Melissa Maldonado, and James Markham. Their patience, professionalism, and guidance is greatly appreciated.

I also owe a great deal of gratitude to Mark Lupo and Todd Carlisle of the Columbus, GA SBDC (Small Business Development Center) office. Their years of experience in assisting the development and growth of small businesses gives them a valuable perspective; they know very well that any business can always benefit by cutting costs when feasible. They also know how important it is for new business upstarts to save as much as possible. Their counsel during the development of this book was invaluable, and is greatly appreciated.

# Introduction

The first time I ever heard of free and open source software goes back to the early 2000s, when I first tried GIMP (GNU Image Manipulation Program), a free photo editing alternative to Adobe Photoshop. At the time, I was a die-hard Photoshop user, so I dismissed it after about five minutes and never gave it any more thought. When I needed software for my business, I just drove to the nearest office supply store, found what I needed, and purchased it. In those days, I thought paid software was the only way to go (and I spent a lot). My views on that changed drastically a few short years later.

In early 2009, I was relaunching my business in a new city (my family and I relocated in late 2008). We had actually planned this move for a couple of years, but the timing of the sale of our house coincided with the unfolding Financial Crisis. Like many other families, we were impacted in a negative way. Our relationship with money was forever redefined, and careful budgeting became a top priority.

My wife, Sally, decided it was time to update her resume in order to search for work that could be done from home, so we purchased a resume creation software package for about \$20.00 and a new, discontinued model computer at a deep discount. The computer (which was running Windows Vista) did not come with Microsoft Word installed. MS Word was required to use the resume creation software.

At that time MS Word cost about \$100, which was more than our budget allowed. I went online in search of a possible alternative. Before long, I discovered a program called OpenOffice that claimed to be a free, fully functioning alternative to MS Word, and compatible with Word files. After downloading it and trying it out, I was very pleasantly surprised. It worked with the resume creation software just fine, and my search for a document creation program ended right there. And the best part was, the license allowed me to copy it and install it on multiple computers—all at no cost!

My discovery of OpenOffice was like finding a one hundred dollar bill I had forgotten about. With our situation the way it was, it was a truly fortunate find: Sally could work on her resume, and I could install OpenOffice on my computer and create sales letters to acquire new customers.

## Who This Book Is For

This book was written primarily with business owners and managers in mind, but any frugal-minded computer user can find it useful. For the business owner who carefully watches over the expenses of her enterprise, this book points the way to some viable, free software solutions. It can be especially helpful to new, small business upstarts, serving as a reference to help quickly find viable alternatives to expensive software.

Operating capital is often limited during the early phase of launching a new venture, so (along with other common sense budgeting strategies), it pays to keep as much cash in your business as possible (Figure 1). Using free software when possible can help you accomplish this.



**Figure 1.** *Using freeware and open source software can help you keep more cash in your business*

There are many free software titles available that you may not be aware exist. While writing this book, I took a poll of about 50 business owners (hardly a scientific survey, but it was telling). Only a couple of them had heard of free, open source programs such as GIMP or OpenOffice. Most of them didn't know that there is a large assortment of free software programs available that could potentially save them money. The savings will vary depending on the nature of the business and its software requirements. Savings can amount to several hundred dollars annually for solo graphic design freelancers to thousands of dollars for larger organizations.

Schools, teachers, and students can benefit as well. For example, if a high school operating under tight budget restraints can't afford the Adobe Creative Cloud lineup for a digital arts class, there are several popular open source alternatives (such as GIMP and Inkscape, a vector drawing program).

A class with ten workstations (Figure 2) could save about \$1,200 annually, based on Adobe's educational pricing of \$19.99 per month per license for installation on up to two computers. An added benefit is that the student can install the same free open source programs at home for homework projects, saving the student (or parents) a few hundred dollars annually.



**Figure 2.** Using open source software instead of the Adobe CC can save about \$1200 annually on ten workstations

## What's The Difference Between Freeware and Open Source Software?

As the question implies, freeware and open source software are not the same. Although each type can usually be used free of charge, the differences lie mainly in the terms of use set by the licensing agreement.

For the purpose of this book, free means that all of the software outlined in this book can be used free of charge, both for personal and commercial purposes. However, free as defined by the Free Software Foundation and the Open Source Initiative means freedom, as in the freedom to modify the source code, make copies for others, and install on multiple computers, to name a few examples. In essence, the user is free from the restrictions imposed by the license of proprietary software.

**Freeware:** Generally speaking, freeware is proprietary software that can be used free of charge, but modifying the source code is not permitted. The terms of use regarding freeware vary from one program to the next. Some freeware is created by individual developers and other freeware applications are created by corporations. One freeware program's license might allow you to make and distribute free copies to friends and coworkers, but prohibit selling them. Another might only allow you to make one backup copy, and prohibit any type of distribution. It's always advisable to read the license agreement carefully before installing and using freeware.

Some freeware programs have limited features with the option to upgrade to a more feature-rich, paid version of the program. Two examples that will be discussed in Chapter 3 are Serif PagePlus and DrawPlus Starter Editions. Although they are not the full version programs, they may be perfect for those wanting to design basic printed materials or create graphic designs.

Some freeware is web-based, so there is nothing to download because it is operated using your browser. You don't have to worry about installation or upgrades (but you are still bound by the terms of the license).

**Open Source Software:** Open source software is also known as free software (not to be confused with freeware). Most of the open source software outlined in this book falls under the terms the GPL, or General Public License (it's often prefixed with the GNU to read GNU GPL). This is the most widely used free software license. A huge advantage this offers over proprietary software is that the software can be freely copied and distributed to friends and coworkers (Figure 3).



**Figure 3.** Free and open source software under the terms of the GPL can be freely copied and distributed

Some software titles described in this book fall under other license types, such as the Mozilla Public License, MIT, or BSD. Since it's beyond the scope of this book to describe in detail the differences of each license type, I suggest you go to the Open Source Initiative page at <http://opensource.org/licenses>.

Essentially, the GPL is a copyleft license, which means modified works must be distributed under the same license terms. For instance, when someone creates a modified version of the photo editing program GIMP, then they must make the new version available with no restrictions under the same GPL terms. This ensures that free software remains free.

For a more comprehensive explanation of how the terms under the GPL work, I suggest reading the article by Brett Smith available on the GNU Operating System website at <https://gnu.org/licenses/quick-guide-gplv3.html>.

---

■ **Note** The Free Software Foundation and the Open Source Initiative (which splintered from the FSF and formed in 1998) differ philosophically somewhat on how free/open source software should be promoted.

---

## The Growing Use Open Source Software in Europe

According to reports by Abhishek Prakash, the creator of the open source advocacy website named It's F.O.S.S ([www.itsfoss.com](http://www.itsfoss.com)), there's a trend in adopting open source solutions. A growing number of city governments throughout Europe have migrated away from proprietary software and embraced free and open source alternatives. The primary reason: savings. By switching from proprietary to open source alternatives, several cities in France, Italy, and other countries have enjoyed savings of millions of Euro.

Here's a look at several European municipalities that have benefited financially by adopting open source software and computer operating systems:

- **Toulouse, France:** The fourth largest city in France saved about one million Euro by replacing Microsoft Office with the open source office productivity suite LibreOffice. The migration took about 18 months, and as of July 2014 about 90% of the desktop computers (about 10,000 city employees) run LibreOffice. [1]
- **Turin, Italy:** This Italian city recently opted to move from Windows XP (which is no longer supported by Microsoft) to Ubuntu Linux, a free computer operating system (Linux systems are explored in greater depth in Chapter 10). This migration should result in a project savings of around 6 million Euro during a five year period. [2]
- **Udine, Italy:** Like Toulouse, Udine opted to migrate away from Microsoft Office. This city of 100,000 will eventually be installing OpenOffice (from which LibreOffice was born) on its 400 computers. The projected savings will be about 360,000 Euro. [3]
- **Canary Islands:** This Spanish autonomous territory has saved about 700,000 Euro by switching to open source software. [4]

One important point to keep in mind is that migrating from proprietary software to open source (especially on a large scale) must be done properly. It takes time to get everyone involved acclimated, and it is generally done gradually. In short, there must be a plan in place. Switching from Microsoft Office to LibreOffice on 200 workstations at once could throw the company into chaos.

The Document Foundation provides a helpful whitepaper on migrating from Microsoft Office to LibreOffice as a downloadable PDF at <https://documentfoundation.files.wordpress.com/2013/03/tdf-migrationwhitepaper1.pdf>.

It might not be possible to completely escape the necessity of using proprietary software on some workstations. For example, the owner of a medium-sized graphics design company might want to switch from Adobe products to open source programs. But because they exchange Adobe files with some of their clients, they must still use Adobe software. A careful analysis might determine that the company could do fine by having Adobe assigned to two, three, or four workstations, and using an open source program on the rest (Figure 4). That number, of course, would vary from one company to another. Another company might require Adobe on half the workstations, but they would still save money by using open source on the remaining half.

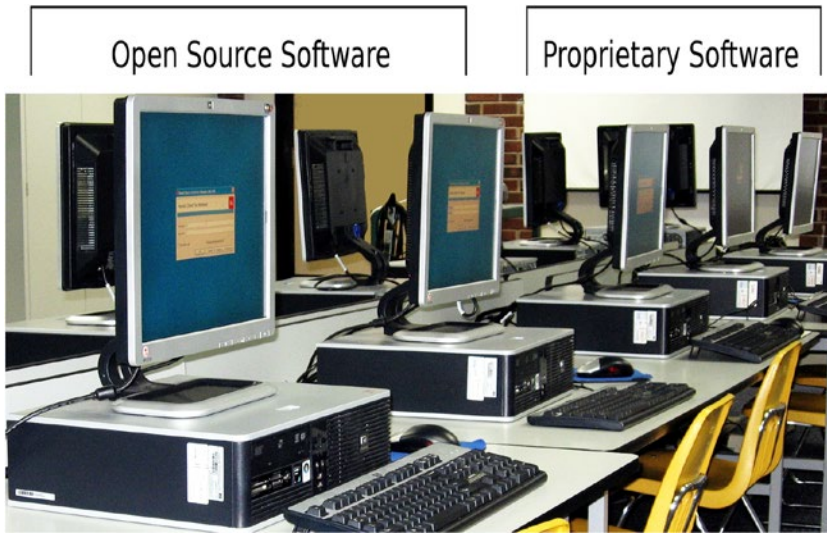

**Figure 4.** *By relegating proprietary software to the minimum number of workstations possible, open source can be used on the remaining workstations*

## Supporting Open Source Software

Free and open source software (and much of the freeware developed by generous individuals) is available at no charge, but donations are a huge force in the continued development of these programs. Many of the people that are involved in the development of open source software work on a volunteer basis. I personally use open source software almost exclusively and make it a point to make fairly regular contributions to the developers.

Open source can be supported in other ways as well: becoming an advocate, giving away copies, teaching others how to use open source programs, writing about open source, etc. People talented in writing computer code can contribute by helping make their favorite programs even better (Figure 5).



*Figure 5. Talented code writers contribute to open source by making good software even better*

Understandably, many business owners may simply be too busy running their enterprises to become deeply involved in open source advocacy. You might not have time to shout about the merits of open source from the mountain top. However, making a donation once in a while will certainly help. It only makes sense to contribute to the betterment of your favorite open source programs.

## Getting Support for Open Source Software

One great thing open source has going for it is that just about every program (GIMP and Inkscape are a couple of examples) usually has a very active community. The forums are great places to find help if you have trouble using a particular program. Most of the forum members are glad to help out. It's sometimes easier to get help for open source programs than their proprietary counterparts. Calling technical support and being on hold for long periods, paying for support that doesn't always supply the correct solution, and other hassles are common with proprietary software.

Some open source programs offer paid technical support, particularly if the software is designed for larger enterprises. However, there are usually the same avenues of free support in place, such as user forums and downloadable documentation.

YouTube is another great learning resource. This video-posting platform now hosts just about any kind of tutorial you can imagine. More often than not, you'll be able to find good tutorials on any given software title.

---

■ **Note** LinkedIn ([www.linkedin.com](http://www.linkedin.com)) is another way to connect with open source users. There are groups for many (if not most) of the software programs examined in this book. Group members are very helpful, and your questions will usually be quickly answered.

---

## Summary

Hopefully, you are enthused about the potential savings offered by freeware and open source solutions. You've now learned the fundamental differences between the two. You've also been made aware of the growing trend of open source software in cities across Europe. Lastly, you looked at some of the ways open source can be supported, and how to get support for the open source programs you use (or might come to use).

Now, feel free to look around in this book for the software solutions you need. There are additional software titles mentioned in the Appendix of this book.

## References

1. "French City Toulouse Saved 1 Million Euro With LibreOffice", July 31, 2014 by Abhishek Prakash.
2. "Italian City Turin Opts For Ubuntu And Open Office To Save Millions", September 17, 2014 by Abhishek Prakash.
3. "Another Italian City Says Goodbye To Microsoft Office, Will Switch To OpenOffice Soon", September 17, 2014 by Abhishek Prakash.
4. "Canary Islands Saves 700,000 Euro With Open Source", March 4, 2014 by Abhishek Prakash.

## CHAPTER 1



# Office Productivity, Note Taking, Accounting, and PDF Creation

Everyone in the civilized world has heard of software programs like Microsoft Word, QuickBooks, etc. Although the alternative software titles we'll look at shortly have been around for years and are no secret, I'd venture to guess that there are many business owners who have never heard of them (or at least not all of them).

This chapter looks at free software alternatives to commercial programs commonly used in office environments. This software is used for creating letters and documents, creating PDF files, and handling business accounting.

Here's a quick look at the software titles covered in this chapter:

- **AbiWord:** A basic word processing application
- **LibreOffice:** A full-featured office productivity suite for creating documents, spreadsheets, etc.
- **Zim:** An open source note-taking application for single users
- **Google Keep:** Google's free note-taking application you can share and sync across devices
- **GNUCash:** A powerful open source accounting program
- **Manager:** An easy-to-use, free accounting program with upgrade options
- **PDF reDirect:** A handy PDF creation tool with upgrade options

All of the programs discussed in this chapter work in the Windows environment, and most work in Mac OS and Linux as well. The first two programs we'll look at are alternatives to Microsoft Word and Office.

## AbiWord: Simplicity in Word Processing

For those who run a small, solo business or just need a basic, easy-to-use word processing application instead of a full-blown office suite, AbiWord might just fill the bill.

**Here are a few facts about AbiWord at a glance:**

- **Alternative to:** Microsoft Word
- **Website:** [www.abiword.org](http://www.abiword.org)
- **License:** GPL

- **Current Version:** 3.0.1
- **Operating Systems:** Windows, Mac OS, Linux
- **Potential Savings:** \$109.99 per license

According to the AbiWord website, “AbiWord is able to read and write all industry standard document types, such as OpenOffice.org documents, Microsoft Word documents, WordPerfect documents, Rich Text Format documents, HTML web pages, and many more.” My own experience is that it usually opens simple Word documents without issue, but it does have some limitations.

It was able to open the Word document I created a few years ago, a simple newsletter with a photographic image (Figure 1-1). However, it may alter the appearance of more complex documents, such as those that utilize a template heavy in graphical elements. This program is a good choice for those who print mostly documents created in-house, and cases in which exchanging Word documents with others on a regular basis isn’t a requirement.



**Figure 1-1.** A simple Word document opened by AbiWord

## Feature Highlights

Although AbiWord is a fairly straightforward and basic program, it has most of the features you would expect to find in a word processing application. Here are AbiWord's features, as described in the User's Manual:

- A familiar interface
- Outstanding file import and export, with support for MS Word, WordPerfect, and more
- Unlimited undo and redo capacity
- Solid (X)HTML export, with CSS styles support
- Images
- Spelling support, with optional underlining
- Bullets and Lists
- Styles
- Table of Contents generation and customization through the Stylist
- Complete, intuitive revisions-tracking support
- Nested tables support, nearly unmatched in the field
- Mail merge
- Bidirectional text support
- Command-line and server use modes for document processing capabilities

AbiWord has a collection of templates for business letters (Figure 1-2), fax cover sheets, company directories, and more.

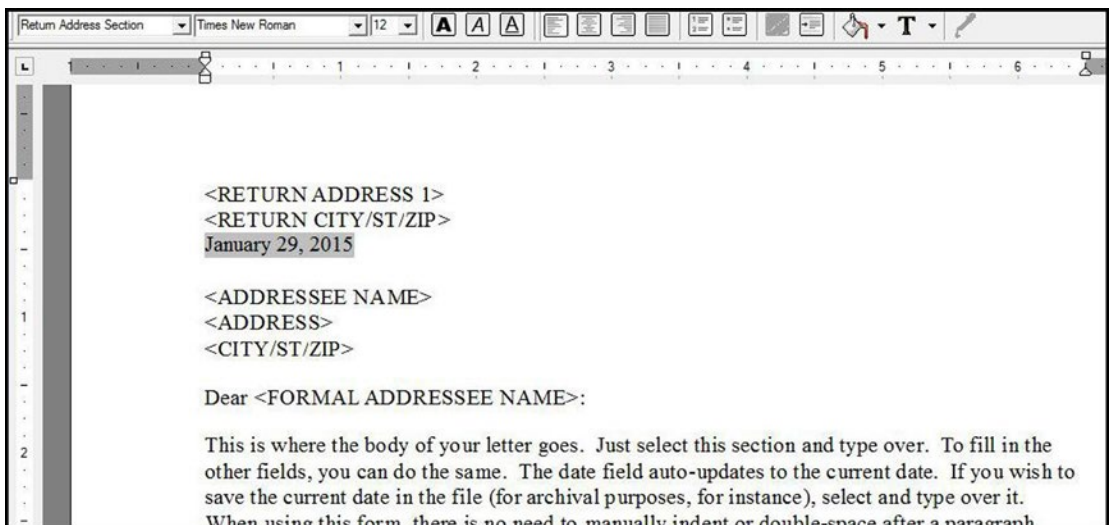

**Figure 1-2.** A business letter template in AbiWord

The program's functions are accessed via the menu and toolbars clustered above the workspace (Figure 1-3).

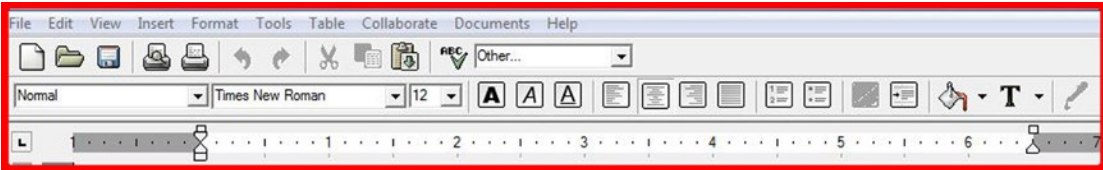
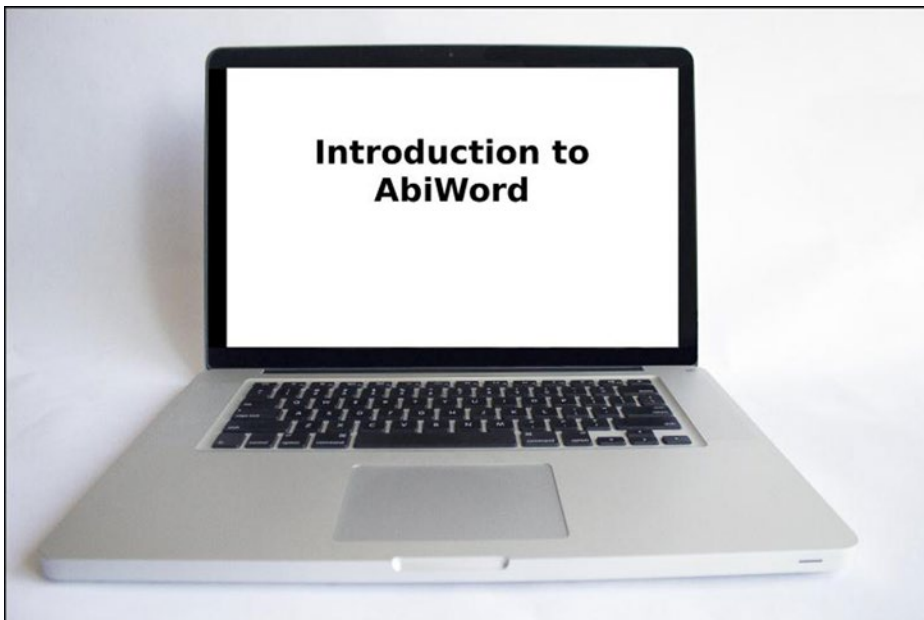

**Figure 1-3.** AbiWord's easy-to-use title, menu, and toolbars

Some people hold on to computers for many years (I fall into that camp) and use them until they just literally wear out. One advantage that AbiWord offers is that it is a small installation and is easy on your computer's resources. If you are using an older PC that could be considered way behind the times, AbiWord is ideal in that it won't bog your system down (I have it installed on an old Toshiba laptop I bought in 2004 running Windows XP Home edition, and it works fine). AbiWord is the default word processor bundled with some Linux distributions, such as Zorin Lite, which is designed as a lightweight operating system for older PCs.

## AbiWord Support

AbiWord's User's Manual can be accessed from the main website (Figure 1-4), and should provide you with all you need to know about how to use this program. There are also some good tutorials on YouTube for added instruction.



**Figure 1-4.** The user's manual for AbiWord can be found on the main website

As mentioned, this program will probably suit your needs if you need to create documents such as business letters, newsletters, fax cover sheets, directories, etc. and don't need to create complex documents or collaborate with those who use Microsoft Word a great deal. It's weak when it comes to exporting MS Word and HTML documents, so that should be taken into consideration.

## LibreOffice: The Powerful Free Office Suite

Large organizations have embraced this open source software package over the past several years for good reason: it suits their needs and saves them a lot of money.

**Here are a few facts about LibreOffice at a glance:**

- **Alternative to:** Microsoft Office Home and Business 2013
- **Website:** [www.libreoffice.org](http://www.libreoffice.org)
- **License:** MPL V2 (Mozilla Public License)
- **Current Version:** 5.0
- **Operating Systems:** Windows, Mac OS, Linux
- **Potential Savings:** \$219.99 per license

LibreOffice is the open source powerhouse office suite made available by the Document Foundation, which is a self-regulating body. It's comprised of former leading members who were involved in the development of an open source office suite called OpenOffice ([www.openoffice.org](http://www.openoffice.org)). Some of the developers of OpenOffice (because of disagreements over licensing issues) went their own way and created LibreOffice from the source code. The two office suites are very similar and have only minor differences. I chose to focus on LibreOffice for a couple of reasons: the first is because it comes bundled with many Linux distributions, and secondly because it's updated more regularly than OpenOffice.

---

■ **Note** This full-featured suite that can create just about any kind of business document, spreadsheet, chart, or database you need. I use LibreOffice Writer myself on a regular basis to create most of my business correspondence, sales letters, charts, etc. If you have experience with the Microsoft Office Suite, learning LibreOffice should be fairly easy. It is compatible with Microsoft for the most part (the formatting in a complex MS document may appear different when opened in LibreOffice).

---

## LibreOffice Modules

The LibreOffice suite contains the following programs:

- *Writer*: A word processing program similar to Microsoft Word.
- *Calc*: Calc is a spreadsheet program similar to Microsoft Excel.
- *Impress*: This is a multimedia presentation program similar to Microsoft Power Point.
- *Base*: A database program similar to Microsoft Access.
- *Draw*: Draw lets you add visual impact to your documents by creating anything from simple graphics to detailed, technical drawings.

## Writer

*Writer* is more or less the equivalent to Microsoft Word. It is an extremely capable application that can create a wide array of documents. It has the essential templates for creating address labels, business cards, business letters, and the like. LibreOffice’s functionality can be increased by utilizing additional templates for creating brochures, accounting charts, etc. They are available to download from [templates.libreoffice.org](http://templates.libreoffice.org).

The small business magazine article shown in Figure 1-5 was written using LibreOffice without the aid of additional templates, so it’s easy to imagine the possibilities of what you can create by utilizing the templates and extensions that are available for this powerful application.

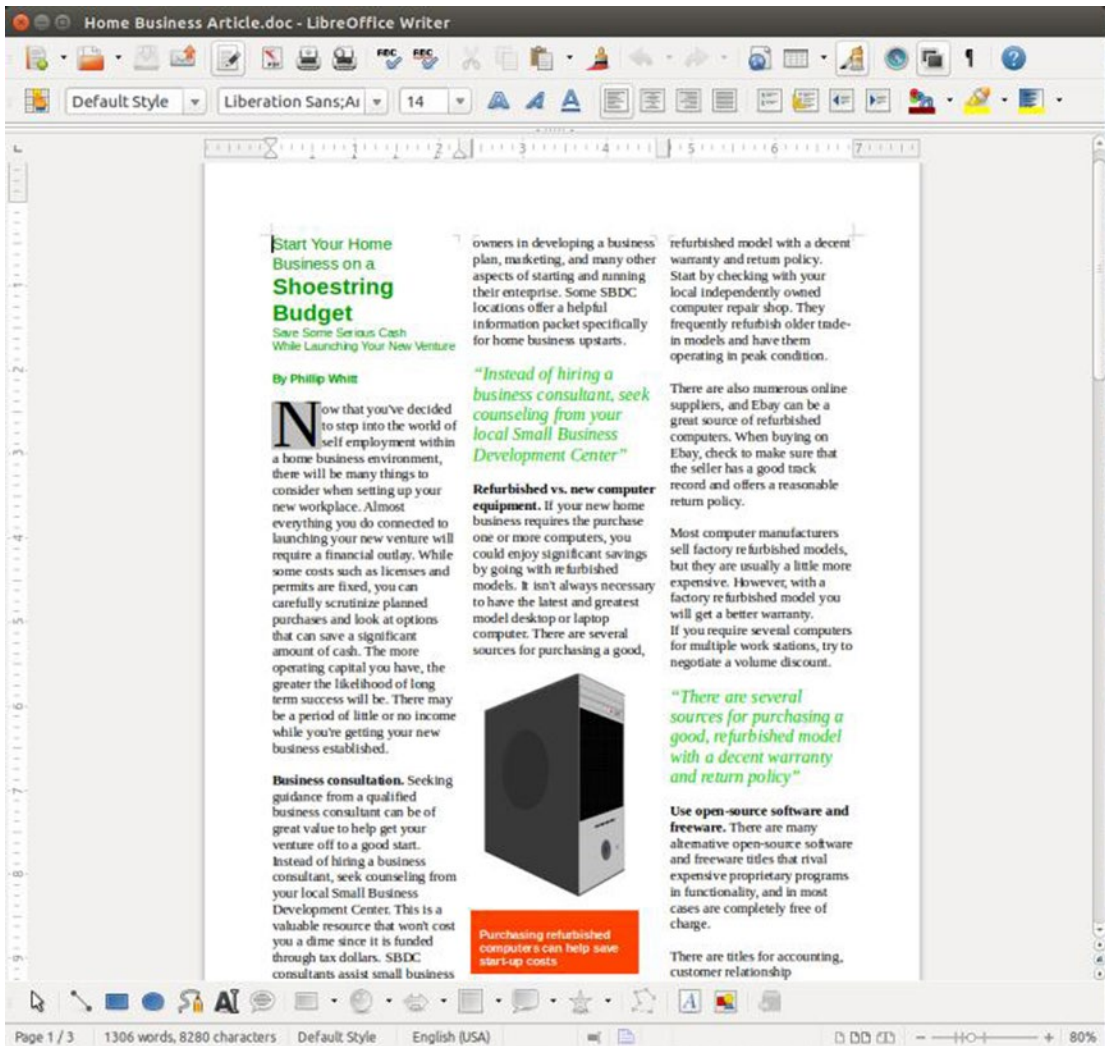
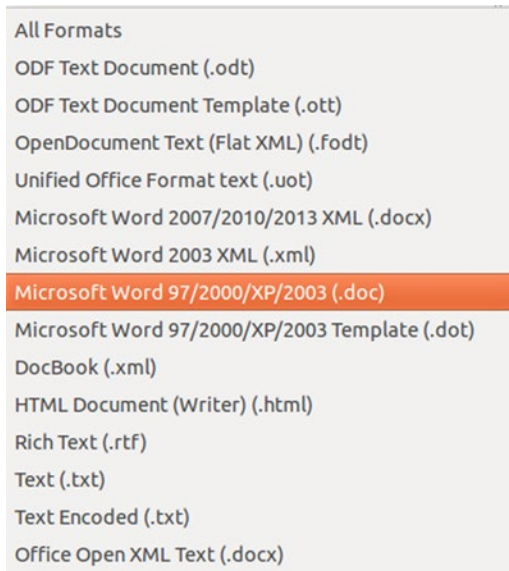

Figure 1-5. A magazine article I created in LibreOffice

LibreOffice saves documents in its native ODF (.odt) format by default. It also allows you to save your document in a wide variety of formats, including Microsoft (Figure 1-6).



**Figure 1-6.** LibreOffice Writer can save your work in a variety of formats

---

■ **Note** According to an article in InfoWorld (July 30, 2014) by Serdar Yegulalp, LibreOffice 4.3 offers more cross-compatibility with Microsoft Office. Although the compatibility still isn't perfect, it seems to be catching up.

---

## Calc

*Calc* is LibreOffice's spreadsheet program and it is similar to Microsoft Excel. It is useful for managing lists, tracking sales, accounting, etc. In the Introduction of this book, I mentioned a survey of local business owners I conducted in the early stages of this book. I used *Calc* to store all of my information as a simple database (Figure 1-7).

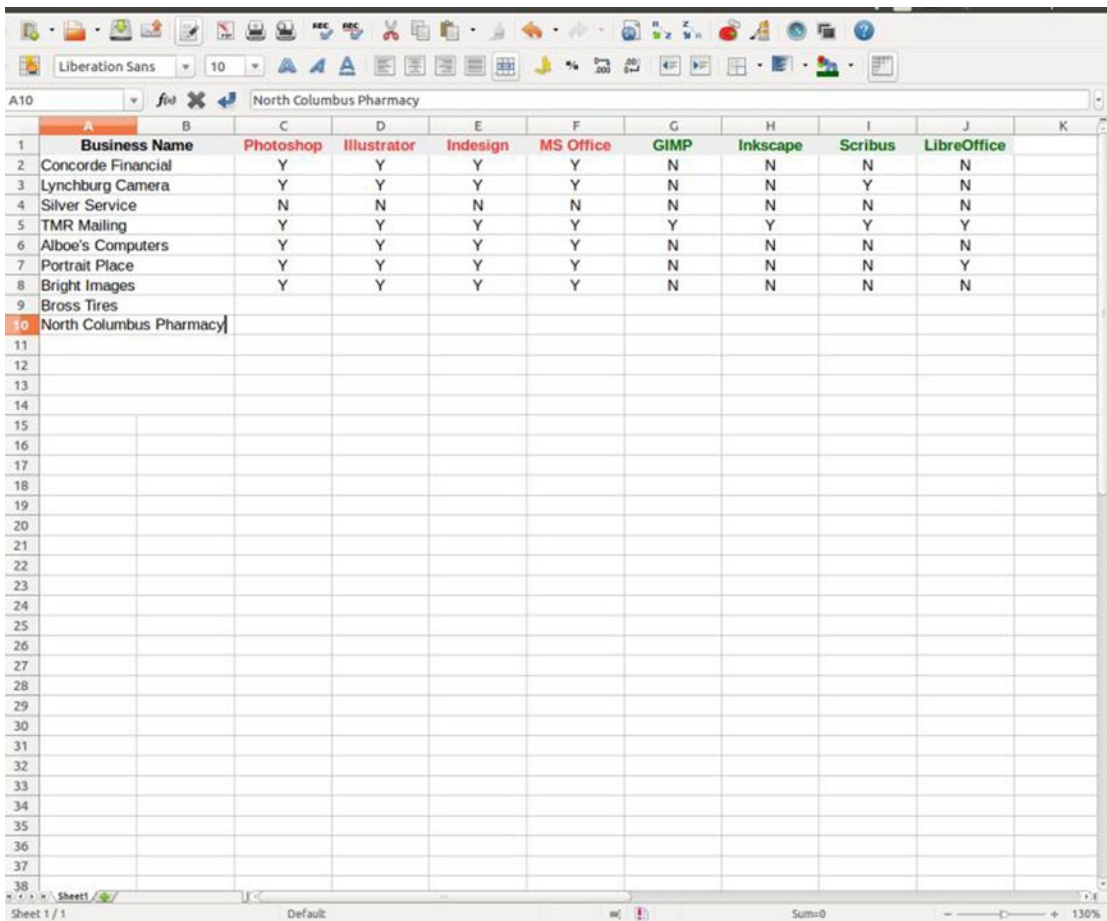
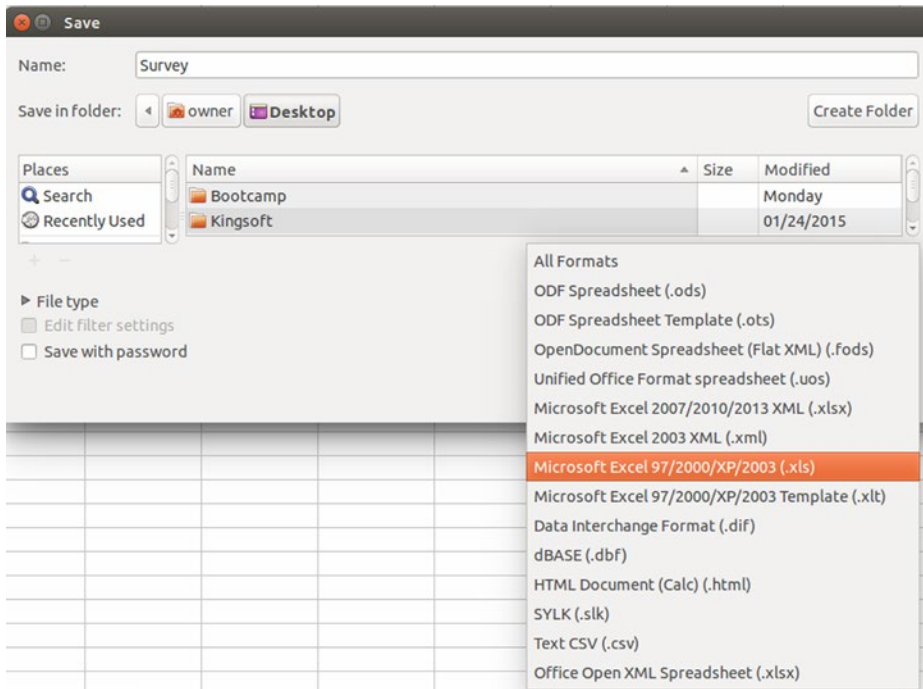

Figure 1-7. The early stages of my small business survey created in Calc

Although I use Calc in my small business, I employ it for a great deal of personal use as well. For people that take a lot of prescription medications (such as my wife), it's very useful for tracking daily medication dispense times and weekly dosages.

Calc's default format is ODF Spreadsheet (.ods), but it will save your work in various formats, including Microsoft Excel 97/2000/XP/2003 (.xls); see Figure 1-8.



**Figure 1-8.** LibreOffice Calc can save your work in a variety of formats

## Impress

*Impress* is the LibreOffice counterpart to Microsoft PowerPoint. This module is for assembling multimedia presentations. You can insert text, images, sounds, and video clips to help add impact to your presentations (Figure 1-9). Like PowerPoint, Impress offers a choice of layouts, slide transitions effects, styles, formatting options, and themes.

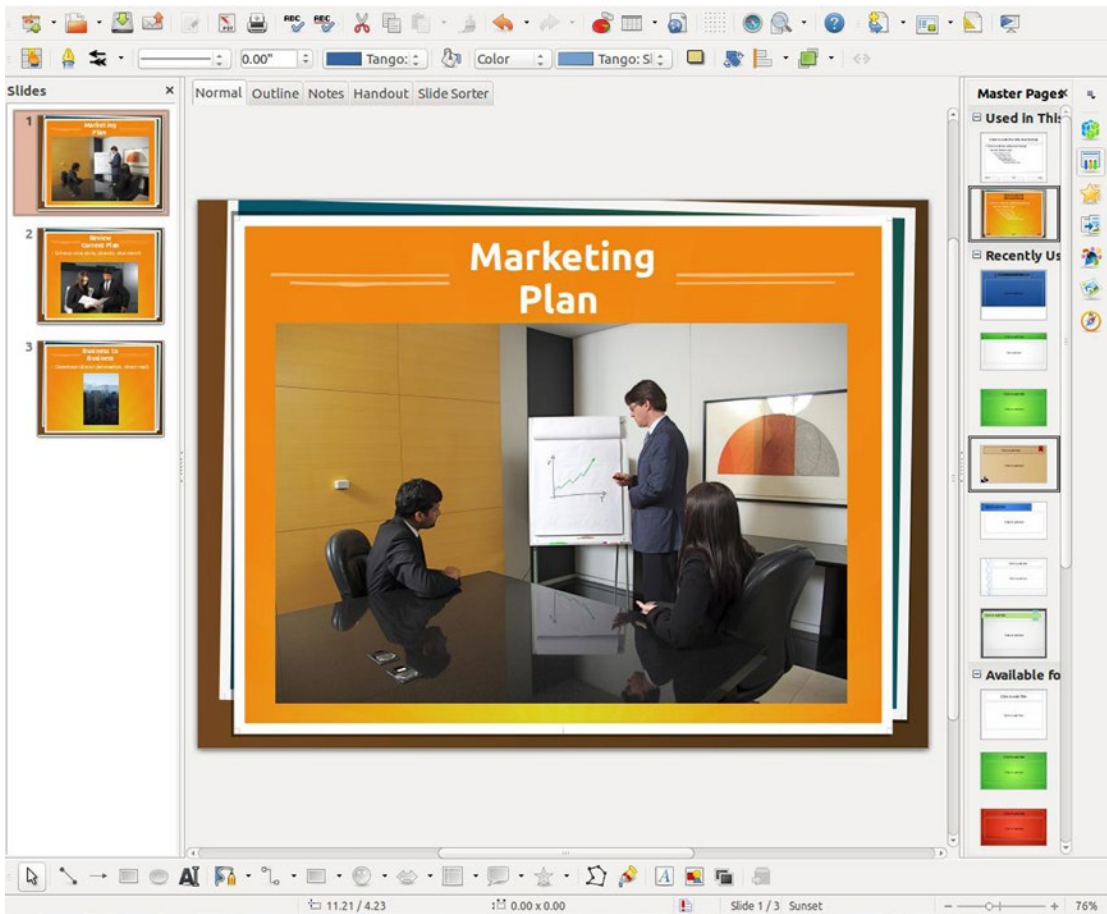

**Figure 1-9.** *Impress can create multimedia presentations similar to PowerPoint*

## Base

*Base* is the full-featured, front-end database module of LibreOffice. It integrates with the other LibreOffice applications. According to the LibreOffice website, Base provides new users with wizards to assist in database design, and to help create tables, queries, forms, and reports (Figure 1-10). Base has predefined table definitions for tracking assets, customers and clients, sales orders, invoices, and many other useful items.

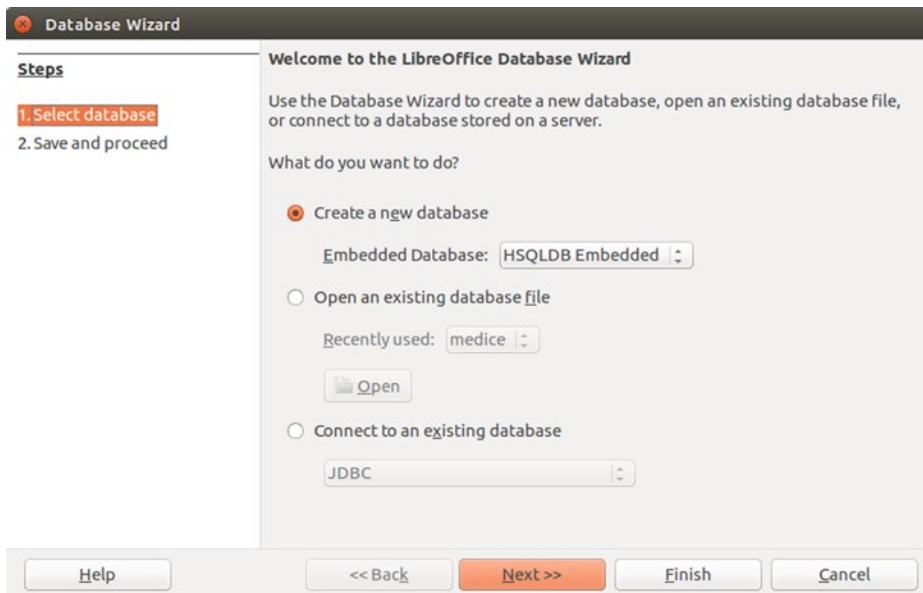

**Figure 1-10.** Base provides a wizard to help new users get started

## Draw

The *Draw* module lets you create and add graphical elements to your documents, and create flowcharts, technical drawings, and sketches. It's easy to use and extremely useful for creating graphics to add visual impact to your documents. (Figure 1-11). Draw offers a number of options for shapes, free-form drawing, gradients and fill colors, call-outs, etc.

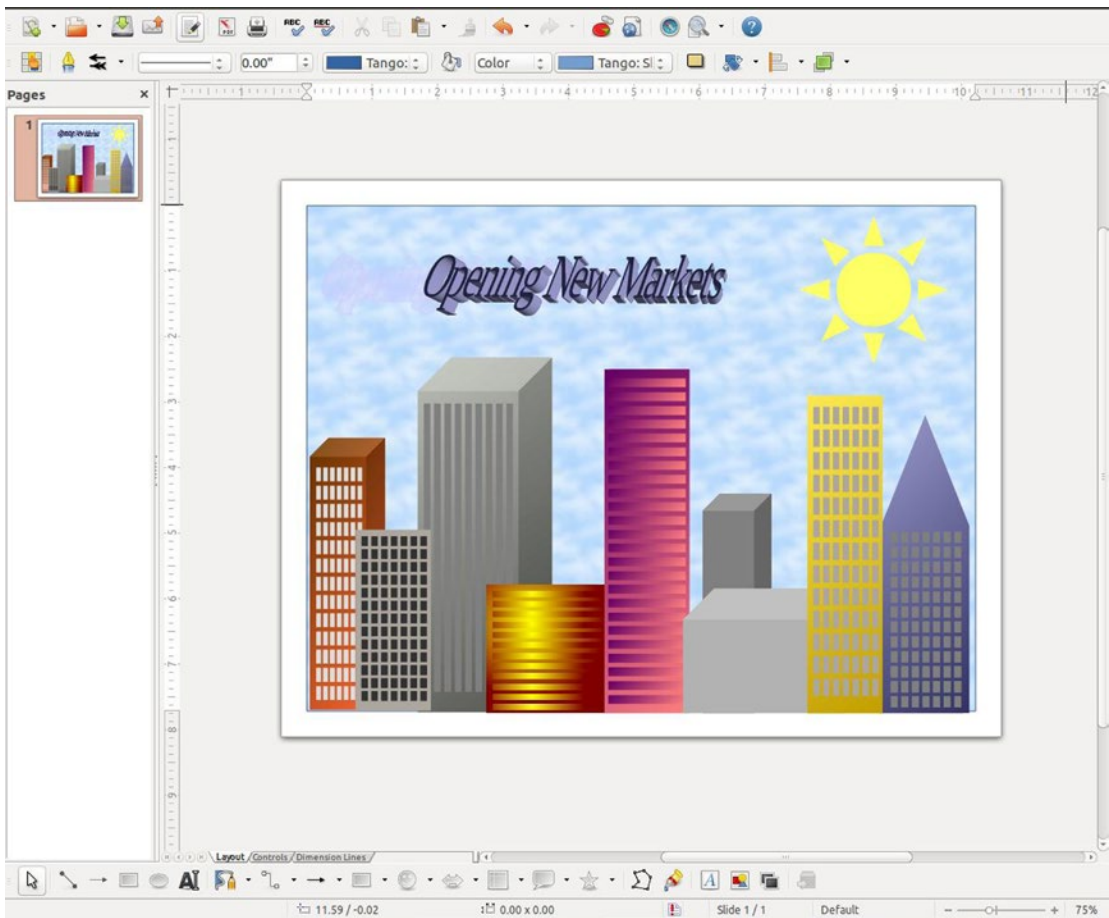

**Figure 1-11.** Draw allows the creation of graphical elements to add visual impact to your documents

---

■ **Note** All of the modules and features described in LibreOffice also reside in OpenOffice. Although there are a few minor differences between the two office suites, they are almost identical in most respects. It's likely that updates for LibreOffice will be rolled out on a more regular basis. However, a disadvantage is that it still does not support Android and iOS development.

---

## LibreOffice Support

LibreOffice is rapidly becoming more popular, so support for the productivity suite will likely increase as time goes on. The first and best place to look for assistance is on the *Get Help* page of the LibreOffice.org website. There are also numerous YouTube tutorials that are very helpful, as well as discussion platforms such as LibreOfficeForum.org (described as the unofficial LibreOffice support forum).

## Zim: Open Source Note-Taking Application

Zim is an application for taking notes, creating journals and to-do lists, inserting images and links to websites, and adding documents in the form of wiki pages.

### Here are a few facts about Zim at a glance:

- **Alternative to:** Microsoft OneNote 2013
- **Website:** [www.zim-wiki.org](http://www.zim-wiki.org)
- **License:** GPL
- **Current Version:** Unspecified
- **Operating Systems:** Windows, Mac OS, Linux
- **Potential Savings:** \$69.99 per license (OneNote is free for Windows 8)

Zim is a nice organizational tool (something like a digital planner/notebook). It's not as fully outfitted as MS OneNote or Evernote, but if you work primarily from one computer, it will help you keep track of notes, images, and just about anything in your work or personal life (Figure 1-12).

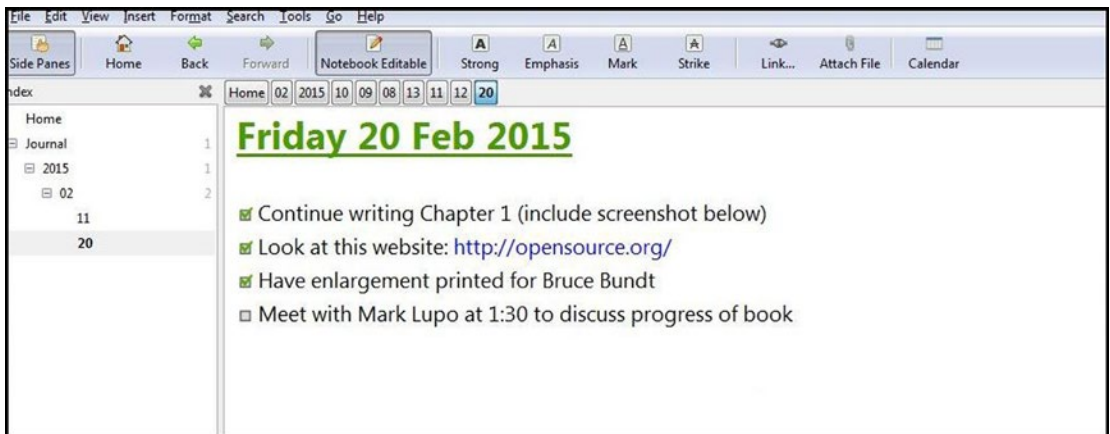

**Figure 1-12.** Zim is a very useful organizational tool for keeping track of notes, images, and links. (Used with permission © Jaap G Karsenberg 2015)

One especially nice feature of this program is that it saves your work on the fly; there's no need to remember to save before closing the program when you're finished.

Zim uses plain text; there's no selection of fonts available but you can make text strong (bold), add italics (emphasis), mark (highlight), and strike (Figure 1-13).

Sample text (plain)  
**Sample text (Strong)**  
*Sample text (Emphasis)*  
Sample text (Mark)  
~~Sample text (strike)~~

**Figure 1-13.** Samples of text variants in Zim (Used with permission © Jaap G Karssenbergh 2015)

Zim allows you to add new pages and subpages, and open new notebooks. This is very helpful for keeping notes organized into specific categories (Figure 1-14).



**Figure 1-14.** Zim allows you to add new pages and subpages, and to open new notebooks. (Used with permission © Jaap G Karssenbergh 2015)

## Zim Support

There is a detailed user manual that accompanies this program located in the *Help* section, as well as the website (Figure 1-15). The manual covers just about everything related to using Zim. There are also a few YouTube videos that give quick and helpful overviews of this program.

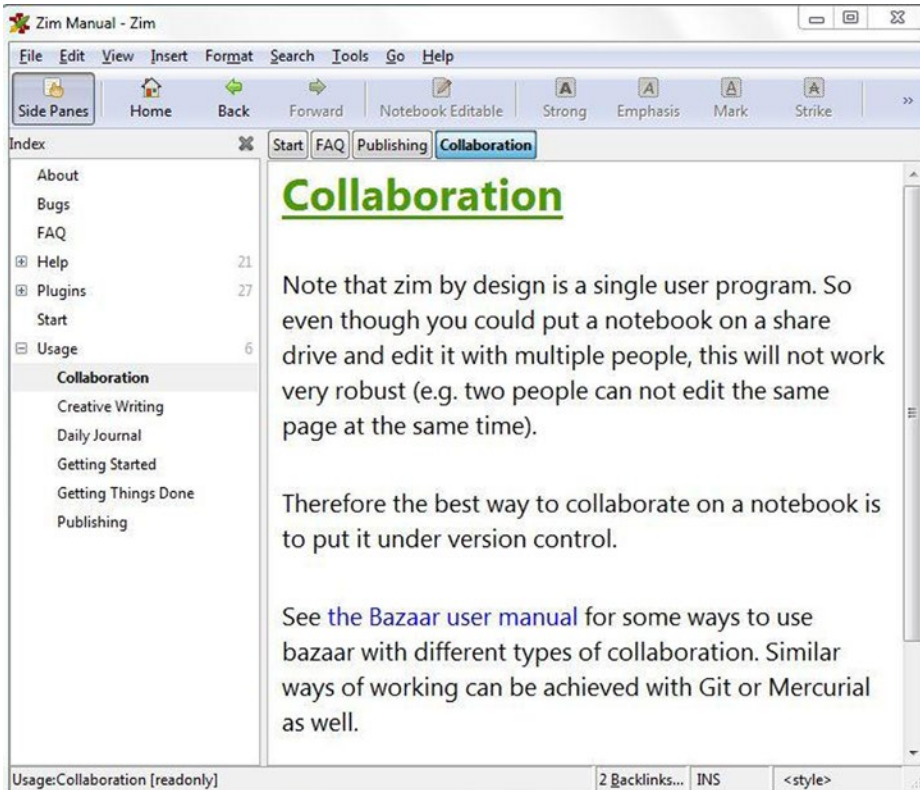

**Figure 1-15.** The Zim Manual is located in the *Help* section

---

■ **Note** The user documentation (<http://zim-wiki.org/manual/Start.html>) states that Zim does have limited collaboration capabilities (such as putting a notebook on a shared drive), but it is primarily a single-user application.

---

## Google Keep: Create, Sync, and Share Notes

Google Keep is a free note-taking application available for Gmail account holders (and if you don't have one, it's easy and free to sign up for one). A great feature about Google Keep is that it syncs across your devices, so you can access your notes from anywhere.

**Here are a few facts about Google Keep at a glance:**

- **Alternative to:** Microsoft OneNote 2013
- **Website:** [www.keep.google.com](http://www.keep.google.com)
- **License:** Proprietary Freeware
- **Current Version:** Not Specified
- **Operating Systems:** Windows, Mac OS, Linux, Mobile Devices
- **Potential Savings:** \$69.99 per license (OneNote is free for Windows 8)

Google Keep stores notes in a “sticky note” fashion, in either a grid view or a list view (Figure 1-16). While Google Keep isn’t in the same league as MS OneNote, it can be a very useful application for the small business.

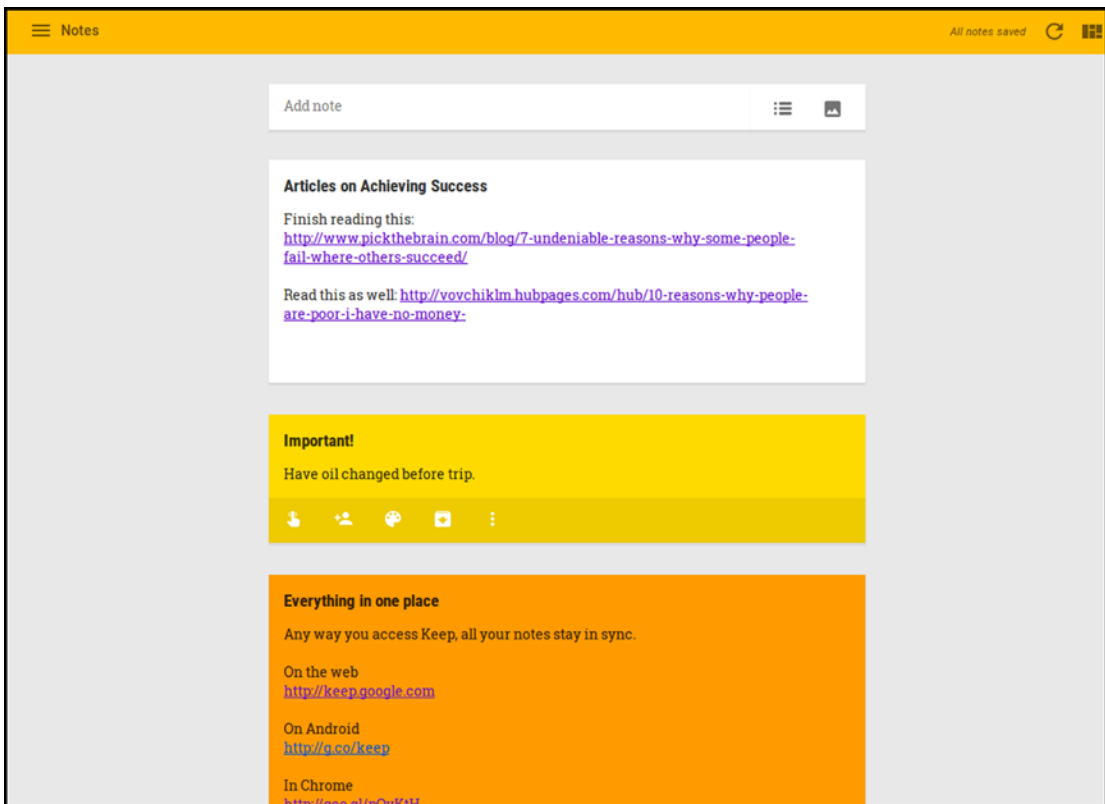

**Figure 1-16.** Google Keep stores notes in a grid view or list view (shown)

## Feature Highlights

Google Keep has several features that make this application very useful. Personally, I’ve never been good with the traditional paper-and-pen type planner; I forget to write down an important note, misplace my planner, etc. Since I’ve been using Google Keep, I stay more organized and orderly.

Here are some of the handy features it offers:

- *Remind Me:* You will receive a reminder to take action on your note.
- *Share:* You can share your notes and collaborate with other Gmail account holders.
- *Color:* You can change the color of the note, which is great for color coding or assigning degrees of priority.
- *Archive:* You can store your note for safekeeping in case you ever need to refer back to it.
- *Delete/Copy:* You can delete your note when it's no longer needed, or you can make a copy of it.

Another handy feature is the New List option that puts a checkbox by each list item. When the box is checked, the list item is crossed off (Figure 1-17).



**Figure 1-17.** A To Do list created using Google Keep. When items are checked, they are automatically crossed off the list

## Google Keep Support

Google Keep is a very easy application to learn and put to use right away. However, there are a number of YouTube videos that provide an overview of the program, as well as tutorials on how to use it for project management, organizing your business, etc.

---

■ **Note** If you have privacy concerns about your notes being “in the cloud,” then you might want to take a look at the web-based note taking application called [www.protectedtext.com](http://www.protectedtext.com). According to the website, it is the safest site on the Web for storing text. The downside is that taking notes is rudimentary. It uses only plain, no-frills text. There are no options for various fonts, checkboxes, or even bullet lists but, like Google Keep, you can access your notes from anywhere.

---

# GnuCash: Open Source Accounting Software

GnuCash is a powerful financial accounting software program for both personal and business use. It's designed to be easy to use yet full-featured.

**Here are a few facts about GnuCash at a glance:**

- **Alternative to:** QuickBooks Pro
- **Website:** [www.gnucash.org](http://www.gnucash.org)
- **License:** GPL
- **Current Version:** 2.6.6
- **Operating Systems:** Windows, Mac OS, Linux
- **Potential Savings:** \$229.99 per license (compared to the QuickBooks Pro perpetual license)

After installing and opening GnuCash, you'll be presented with a *Tip of the Day* that displays at each startup of GnuCash (Figure 1-18). You can disable this feature, but it's a good idea to leave it in place (at least in the beginning) to help you become more familiar with the software's capabilities.

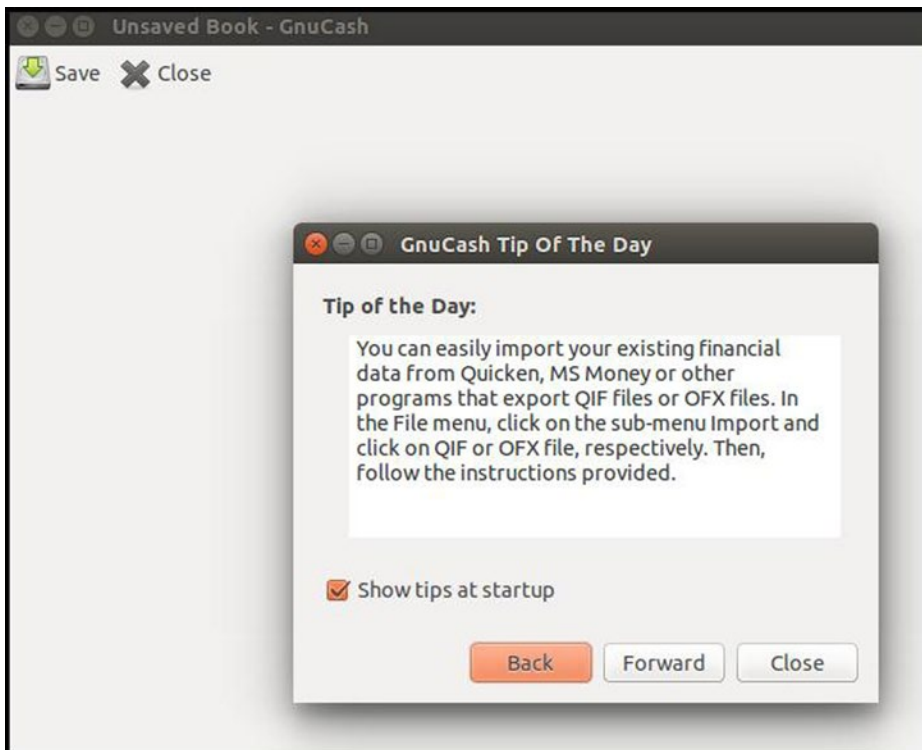

**Figure 1-18.** The GnuCash tip of the Day displays during startup

After launching the program for the first time, it is necessary to set up *accounts* (such as checking, petty cash, savings, accounts receivable, etc.). You can choose the categories that are relevant to the way you'll use GnuCash (Figure 1-19).

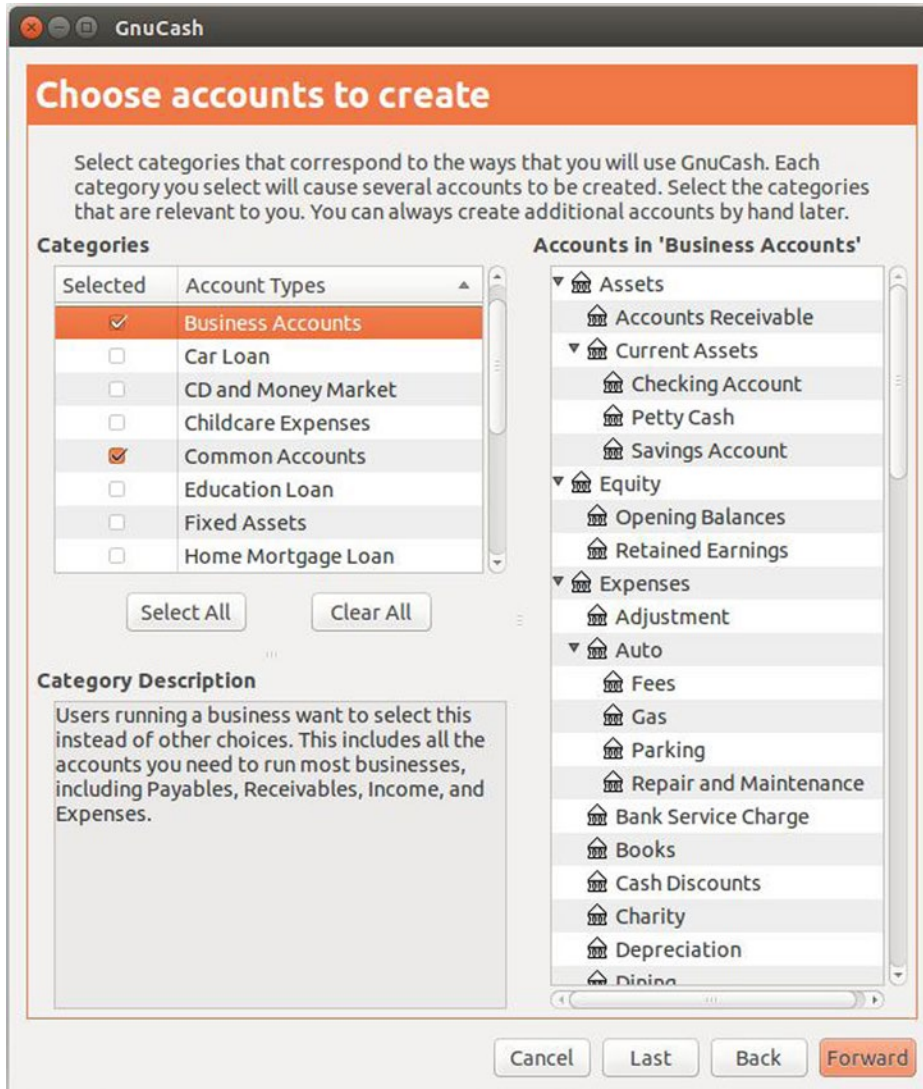

**Figure 1-19.** You can select the categories relevant to how you will use GnuCash

## Feature Highlights

GnuCash is a powerful and robust accounting program. It may be a little intimidating to people with little or no experience with accounting software. However, if you've had experience with programs like QuickBooks Pro, the learning curve shouldn't be quite as steep.

Here are some of the feature highlights listed on the website:

- Double-entry accounting
- Stock/bond/mutual fund accounts
- Small business accounting
- Reports, graphs
- QIF/OFX/HBCI import, Transaction matching
- Scheduled transactions
- Financial calculations

## GnuCash Support

As mentioned, GnuCash can be a little intimidating, but there is plenty of support available. I recommend taking some time to read the documentation such as the *GnuCash Tutorial and Concepts Guide* (Figure 1-20), which can be found on the website or by clicking the *Help* tab of the software's menu bar. There are a number of helpful YouTube tutorials about GnuCash, as well as an FAQ page on the website.

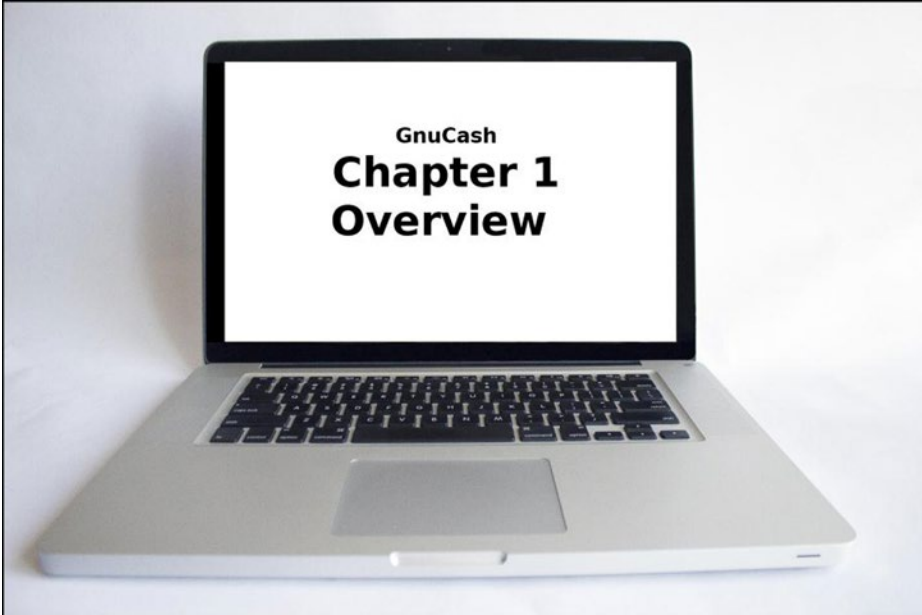

**Figure 1-20.** Starting with the *GnuCash Tutorial and Concepts Guide* is recommended

## Manager: Free Small Business Accounting Software

If GnuCash is a bit overwhelming, then Manager might be more to your liking. It is an easy-to-use, feature-rich accounting program that a small business can appreciate. It states on the website that in addition to being used by businesses and accountants, it is used by educators to teach accounting principles. Although the desktop version of Manager is free, the cloud and server editions are available by paid subscription.

### Here are a few facts about Manager at a glance:

- **Alternative to:** QuickBooks Pro
- **Website:** [www.manager.io](http://www.manager.io)
- **License:** Proprietary Freeware (for desktop version)
- **Current Version:** 15.0.3
- **Operating Systems:** Windows, Mac OS, Linux
- **Potential Savings:** \$229.99 per license (compared to the QuickBooks Pro perpetual license)

I actually started using this software some time back when I installed Ubuntu on my old Dell desktop computer that was running Windows XP. I found it easier to use than the old accounting software (Book Keeper) I had been using since 2006. Manager has many features, as is apparent in Table 1-1, but is still easy enough for non-accountant types such as myself.

**Table 1-1.** Manager's Features as Shown on the Software's Website

General Ledger	Cash Management	Bank Reconciliation
Expense Claims	Accounts Receivable	Accounts Payable
Estimates and Quotes	Purchase Orders	Billing and Invoicing
Credit Notes	Delivery Notes	Sales Orders
Stock and Inventory	Time and Service Billing	Asset Register and Depreciation
Capital Accounts	Profit and Loss Statement	Balance Sheet
Multi-Currency	Custom Fields	Customizable Invoices
Chart of Accounts	Journal Entries	Aged Receivables
Aged Payables	Customer Statements	Remittance Advices
Comparative Reporting	Project-Based Accounting	Import Bank Statements
Recurring Billing	Cash-basis Accounting	Accrual-Basis Accounting
Departmental Accounting	Payroll	Manufacturing
Email Templates	Drill-Down Reports	Email Tracking

The *Manager Guides* on the website provides comprehensive, easy-to-follow instructions on getting started and using this software.

Manager prides itself on using a simple, clean interface that's easy to navigate. If you are well acquainted with bookkeeping, the learning curve for this program should be low enough to jump right in.

Setting up an accounting entity in Manager is made easy by using the *Add Business* tab (Figure 1-21).

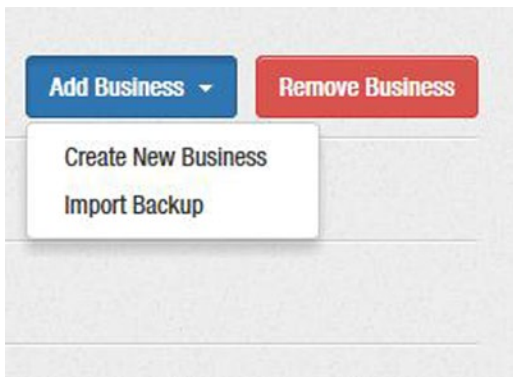

**Figure 1-21.** Setting up your business name in Manager (Used with permission © NGSoftware Pty Ltd 2015)

Manager doesn't require the financial year starting date to add your business name. Simply choose the *Create New Business* option. You'll be prompted to type in your business name, and then add it. You can add additional accounting entities if you operate multiple businesses.

After naming your business, you can customize certain parameters, such as adding employee information, creating sales orders and invoices, and so on (Figure 1-22).

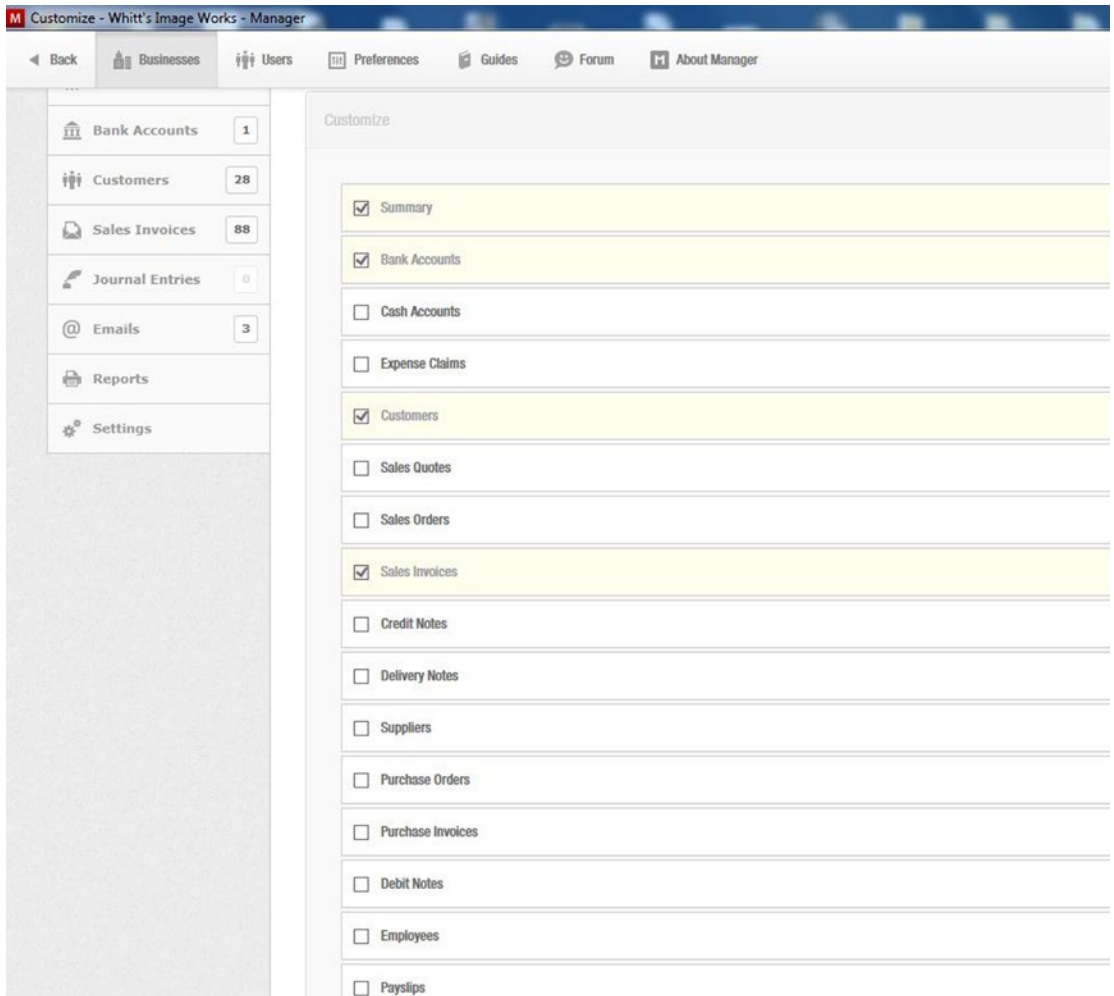

**Figure 1-22.** The Customize feature in Manager (Used with permission © NGSoftware Pty Ltd 2015)

Manager allows you to e-mail invoices to clients, print them on paper, or save them as PDF files by using the Print function to output to a PDF creation application such as *Foxit Reader* or *PDF Redirect* (Figure 1-23).

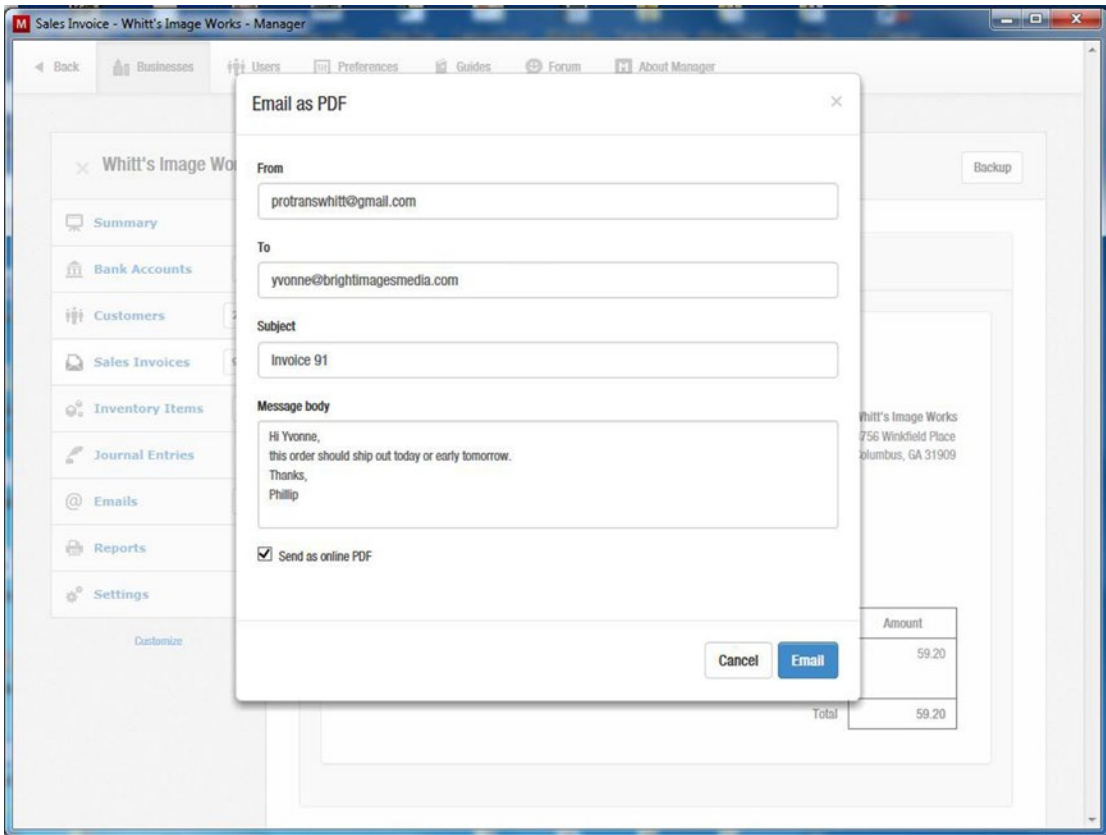

**Figure 1-23.** Manager allows the user to either print invoices, save them as PDF files, or e-mail them to clients. (Used with permission © NGSoftware Pty Ltd 2015)

You can back up your accounting data as a *Manager database (\*.manager)* file and indicate where you would like to save it. In my case, I created a folder on the desktop and named it *Manager Accounting Backup* (Figure 1-24). After I back up my work (which should be done regularly), I then copy it to a thumbnail drive.

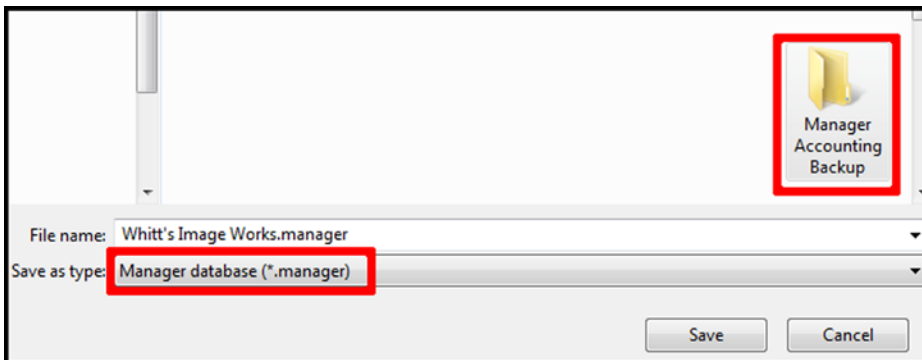

**Figure 1-24.** Backing up accounting data as a *Manager database (\*.manager)* file (Used with permission © NGSoftware Pty Ltd 2015)

## Manager Support

The supporting documentation *Manager Guides* on the website provide comprehensive, easy-to-follow instructions on getting started and using this software (Figure 1-25). Even though you may find Manager an easier program to use than GnuCash, it is still be a good idea to take some time to read through this documentation.

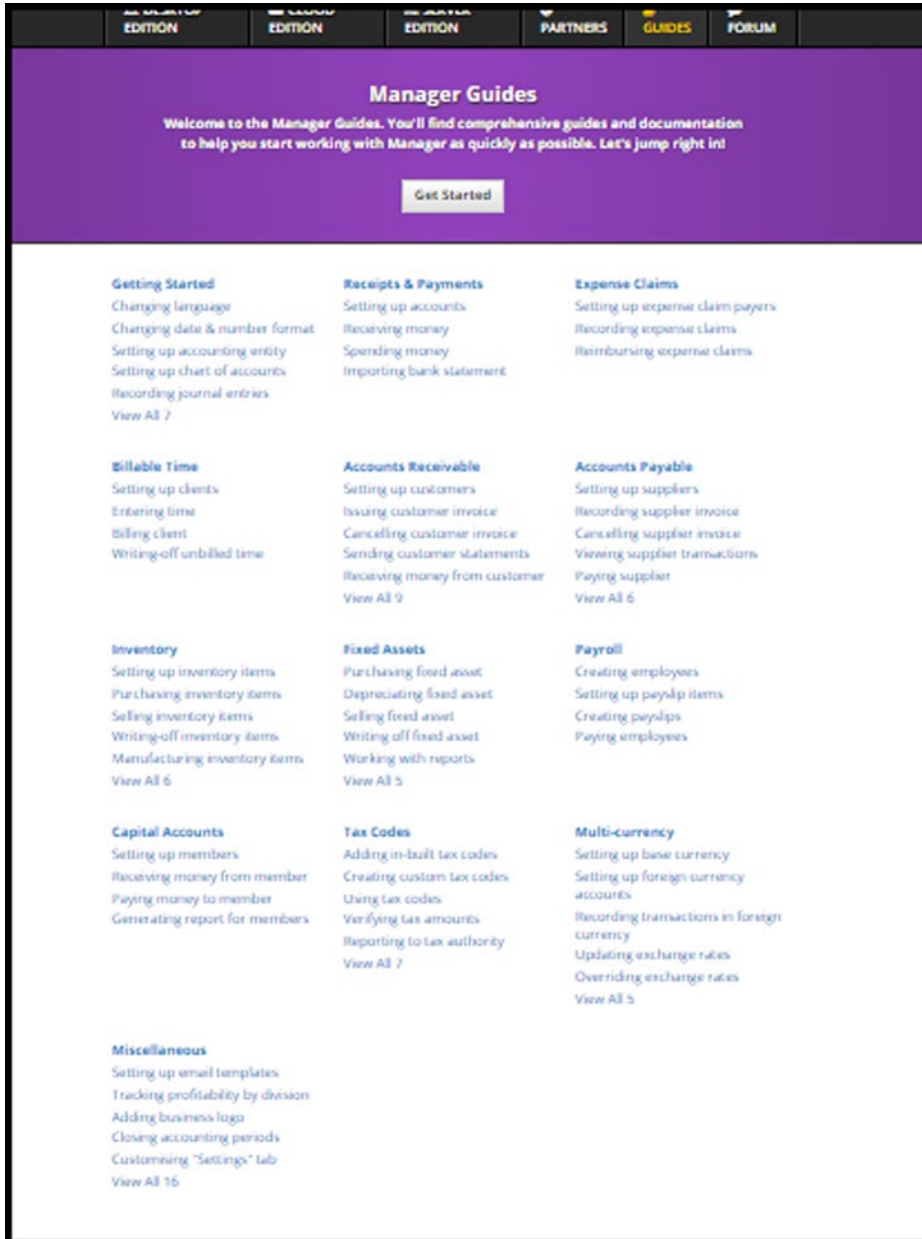

**Figure 1-25.** The Manager Guides offers comprehensive instructions on using the software. (Used with permission © NGSoftware Pty Ltd 2015)

The Forum page on the software provider’s website is a great source of additional information. Manager users exchange information and help each other when they get stuck in using the software (Figure 1-26).

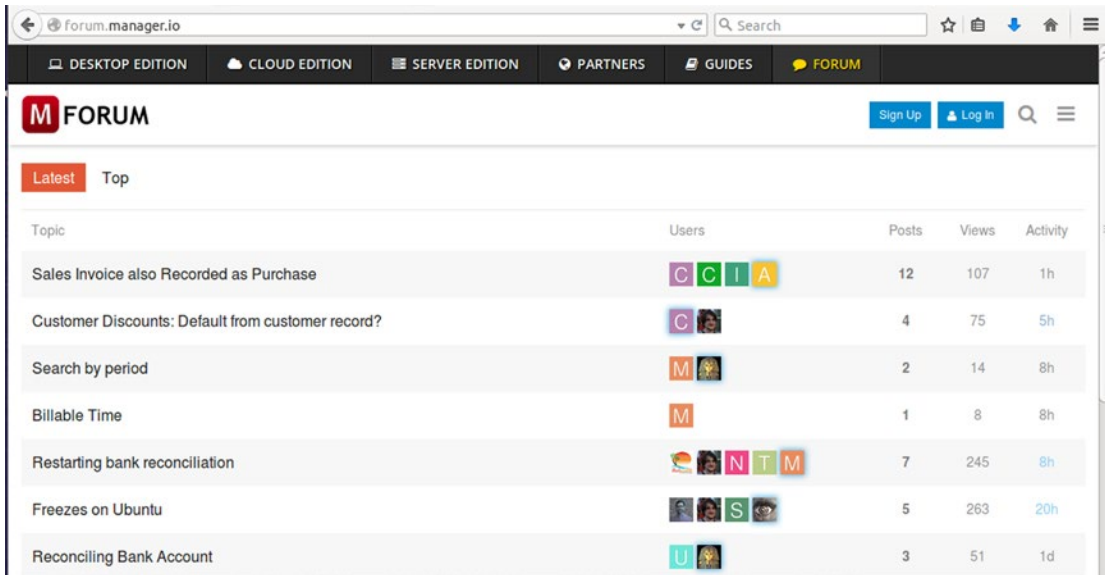

**Figure 1-26.** The Forum page is a great source of support for using Manager. (Used with permission © NGSoftware Pty Ltd 2015)

## PDF reDirect: Basic PDF Creation Freeware

PDF reDirect is an excellent free program for creating PDF files. It has always been a very useful tool in my work. It is used to convert documents (such as those created in MS Word or LibreOffice) into PDF files. The professional version has more features and offers a free 90-day trial; then it costs \$19.99 with free lifetime upgrades.

**Here are a few facts about PDF reDirect at a glance:**

- **Alternative to:** Adobe Acrobat
- **Website:** [www.expsystems.com](http://www.expsystems.com)
- **License:** Proprietary Freeware
- **Current Version:** 2.5.2
- **Operating Systems:** Windows
- **Potential Savings:** \$19.99 per month subscription (compared to Adobe Acrobat)

If you need to create PDF files from existing documents but don’t need all of the abilities contained within a full-fledged program like Adobe Acrobat, then PDF reDirect is really worth trying. When you’re ready to convert your document into a PDF, just use the *Print* command and click *PDF reDirect* in the *Printer* options (Figure 1-27). One downside to this program is that it’s only available for Windows.

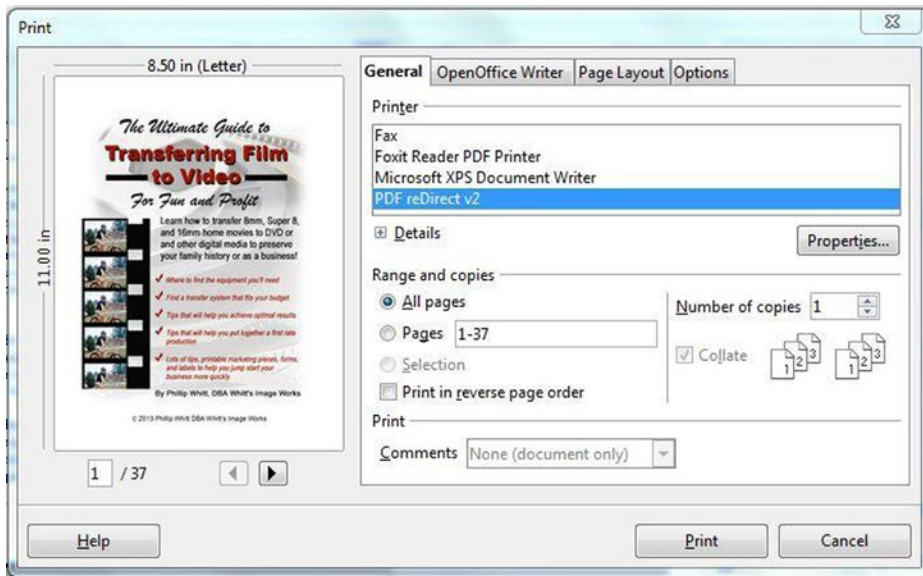

**Figure 1-27.** Select PDF reDirect among the Printer options to convert a document into a PDF. (Used with permission © EXP Systems LLC 2015)

## Feature Highlights

PDF reDirect has several nice features included for being a freeware program. Here's a look at its features as they are listed on the website:

- **Create Standard PDF Files:** Create universal, standard, reliable, and secure PDF files, recognized by industries and governments around the world. Perfect for sharing information with others.
- **Easy to Use:** Compatible with virtually all Windows programs. Simply select *Print*, choose the *PDF reDirect virtual printer*, and your PDF file is created automatically.
- **Live Preview:** A preview of the PDF is displayed so you can optimize your settings on the fly. (The Pro version provides an enhanced preview with greater detail.)
- **Optimize Quality and File Size:** Optimize your PDF files for your intended audience, from high quality for desktop publishing to small web-friendly files.
- **Merge PDF Files:** Combine any PDF files, like a Word report with your Excel charts, into a single PDF by dragging them to the Merge List.
- **Encrypt your PDF files:** Secure your PDF files from prying eyes by using 40-bit password protection. (The Pro version uses a more secure 128-bit encryption.)
- **No Pop-up Advertisements:** There are no annoying pop-up advertisements that appear while your PDF is being created and there are no watermarks to deface your PDF files.
- **Set Viewing Style:** Decide how the PDF file opens in the user's window. Create a full-screen presentation just like PowerPoint with navigation controls.
- **Easy Upgrades:** Find, download, and install upgrades from within PDF reDirect by clicking the *Upgrade* button in the preferences.

PDF reDirect also lets you control the picture quality within the printer output settings. The quality ranges from Low (small file size) to High (large file size). By default, it is set at Very Good, which is the second highest setting (Figure 1-28).



Figure 1-28. The Picture Quality settings range from Low to High. (Used with permission © EXP Systems LLC 2015)

## PDF reDirect Support

PDF reDirect has a good User’s Guide that can be found under the *Support* tab on the website. There is also a discussion platform under the *Forum* tab where users can seek help from others if they encounter problems using the program (Figure 1-29). E-mail support from the software developers is available at [exp@exp-systems.com](mailto:exp@exp-systems.com).

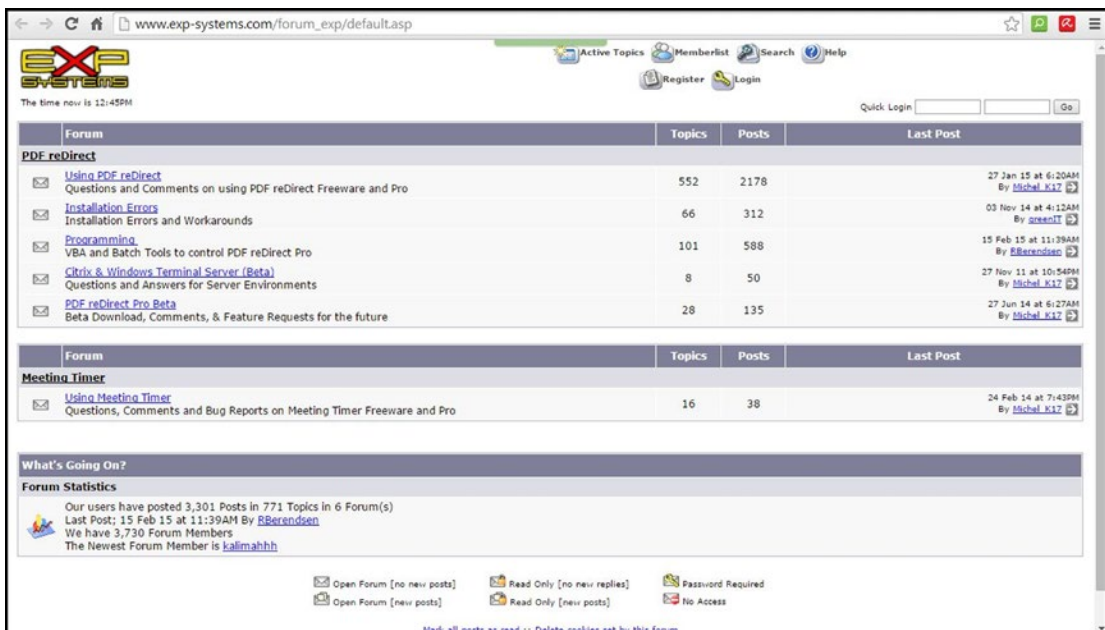

Figure 1-29. The Forum is a great place to seek assistance by connecting with other PDF reDirect users. (Used with permission © EXP Systems LLC 2015)

## Summary

In this chapter, you looked at some useful free and free open source office productivity solutions. AbiWord is an easy-to-use alternative to Microsoft Word, and LibreOffice is a powerful open source suite that is growing in popularity (some city governments throughout Europe are switching from Microsoft to LibreOffice to save a large sum of money on licensing fees).

You learned about two free note-taking applications: Zim and Google Keep. While Zim is a great for use on a single computer, Google Keep lets you access your notes from any device. Google Keep requires that you set up a Gmail account, but it is easy and free.

GnuCash and Manager are two options for free accounting software. While GnuCash is a very robust program, it can be a little intimidating for those with little or no experience using accounting software. Manager is a full-featured yet easy-to-use, free accounting program that (according to the software provider's website) is used by students to learn accounting principles and by small businesses.

PDF reDirect is a useful Windows-based program for converting documents into PDF files. If you don't need all of the features of Adobe Acrobat, this handy, free application might just serve you well.

The next chapter looks at no-cost solutions for point-of-sale, customer relationship management, backup software, and compression software.

## CHAPTER 2



# Point-of-Sale, CRM, Backup, and Compression Software

This chapter looks at several solutions for handling day-to-day sales transactions, managing customer relationships, backing up data, and file compression.

Here's a quick look at the software programs covered in this chapter:

### Point-of Sale Solutions:

- **Imonggo:** The free version of Imonggo offers an online point-of-sale solution for small shops, kiosks, and boutiques.
- **POS/Cash Register:** A free DOS program that can turn old PCs into fully functional cash registers.

### Customer Relationship Management Solutions:

- **Insightly:** An easy-to-use CRM (customer relationship management) tool for up to two users.
- **Bitrix24:** A CRM system (with elements of a social network) that's free for up to twelve users.

### File Backup and Compression Solutions:

- **FBackup:** A freeware Windows program for backing up important ant data.
- **7Zip:** A free compression program similar to WinZip.

## Imonggo (Free Version): A Point-of-Sale Utility for The Small Shop or Boutique

Imonggo is an ideal cloud-based freeware solution for the small one- or two-person shop that keeps less than 1,000 different products, and processes no more than 1,000 transactions per month. For larger shops or stores, Imonggo offers several paid options with more features.

Here are a few facts about Imonggo at a glance:

- **Competitor to:** Vend
- **Website:** [www.imonggo.com/](http://www.imonggo.com/)
- **License:** Proprietary Freeware
- **Current Version:** Not specified

- **Operating Systems:** Cross-platform
- **Potential Savings:** \$69.00 per month

To use Imonggo, the first thing to do is to set up an account (the free version does not require a credit card or banking information). After your account is set up, you can input your product information into the Imonggo Store, such as a product picture, stock number, bar code if applicable, inventory count, etc.

Imonggo works with most major browsers, including the latest versions of Windows Internet Explorer, Google Chrome, Apple’s Safari, and Mozilla Firefox. JavaScript and cookies must be enabled.

## Feature Highlights

The free version of Imonggo offers a lot for the small shop, kiosk, or boutique. Here’s a quick rundown:

- Product pictures supported
- Customizable receipts: You can add your company logo and business information
- Create up to 1,000 products
- Generate up to 1,000 transaction lines per month

For illustrative purposes, I set up a fictitious earring boutique. The *Imonggo Stockroom* is where new products are created. Figure 2-1 demonstrates the product setup of a pair of gold hoop-style earrings with all of the relevant information.

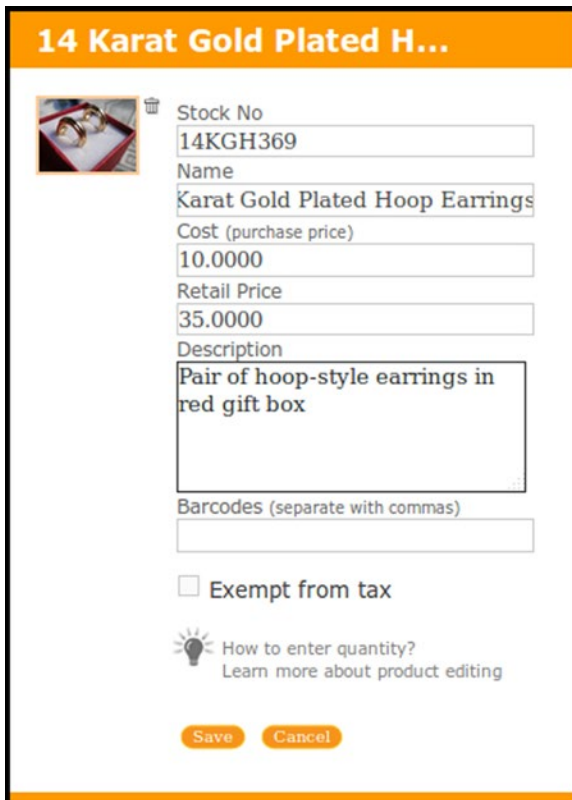

**Figure 2-1.** Creating a new product in the Imonggo Stockroom (Used with permission © Movmento Pte. Ltd. 2015)

Creating a sales transaction is handled in the *Imonggo Store*. You can input the customer's name, plus any relevant information in the Remark box of the invoice (Figure 2-2).



**Figure 2-2.** When creating an invoice, you can enter the customer's name and any relevant information. (Used with permission © Movmento Pte. Ltd. 2015)

---

■ **Note** Collecting customer information in the Remark box can be very helpful for creating customized marketing. Of course, Customer Relationship Management software is better suited for that purpose.

---

When receiving payment for an item, you can select the payment type: cash, credit card, debit card, gift certificate, or other (Figure 2-3). After the transaction is complete, an invoice can be printed.

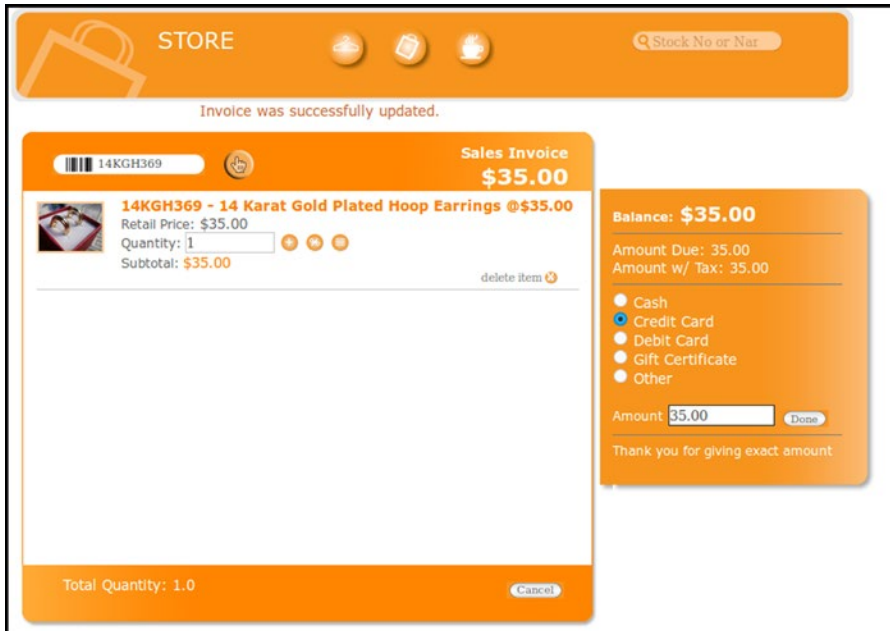

Figure 2-3. Imonggo provides a choice of payment types. (Used with permission © Movmento Pte. Ltd. 2015)

In the Imonggo Office (Figure 2-4), you can handle tasks such as re-printing invoices, running sales reports, viewing customer information, and customizing invoices (the functions are limited in the free version of Imonggo).

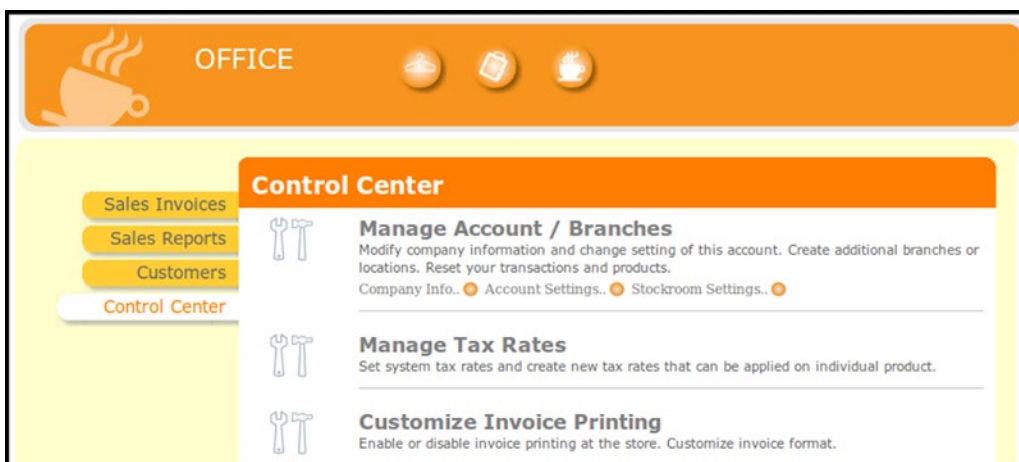

Figure 2-4. Imonggo Office allows customizing and printing invoices, running sales reports, and accessing customer information. (Used with permission © Movmento Pte. Ltd. 2015)

## Imonggo Support

Imonggo is very easy and intuitive to use, and the website offers a great deal of support. After setting up your account, it's a good idea to look at the *Imonggo Video Tutorial Library*. The tutorials should cover just about any area, but if you need further assistance, the support team can be contacted via e-mail; just click the *Support* tab to access the form (Figure 2-5).

**Figure 2-5.** The Support Team offers assistance via e-mail if needed. (Used with permission © Movmento Pte. Ltd. 2015)

## POS/Cash Register: Turn Your Old PC Into a Cash Register

Cash registers can cost several hundred dollars each. The paid commercial software for running computers as cash registers can be expensive as well, depending on its capabilities. POS/Cash Register is a free software program made available from Dale Harris Educational Software (and it *is* permitted for commercial use) that turns an older PC running DOS or Windows into a cash register. It's a DOS program, and does require a little time to set up after installation. There are detailed instructions on the website, and once the program is installed and running, it's a viable way to put older computers to good use and save money in the bargain.

Here are a few facts about POS/Cash Register at a glance:

- **Alternative to:** Copper POS Software (NCH Software)
- **Website:** [keyhut.com/pos.htm](http://keyhut.com/pos.htm)
- **License:** Proprietary Freeware
- **Current Version:** 7.1J
- **Operating Systems:** PCs running DOS or Windows
- **Potential Savings:** \$60.00 per license

Cash Register can be installed on single PCs or on networks. Figure 2-6 shows the POS/Cash Register launch screen.



**Figure 2-6.** The POS/Cash Register launch screen (Used with permission © Dale Harris 2015)

## Feature Highlights

POS/Cash Register is simple yet powerful. It offers a lot for a free program, and it has many fans, judging by the list of companies that use this software on the software provider's website. Here's a look at the features offered by this program:

- Works on older computers running DOS and Windows as far back as Version 3.1
- Prints receipts on almost any printer (inkjet, laser, or specialized cash register receipt printer)
- Works with keyboard wedge scanners or USB scanners
- Keeps track of up to 26,000 different items
- Provides functions such as reservation and table management for any business in the food service industry
- Keeps track of sales of up to 56 different employees
- Records a journal of all transactions on disk as a text file

---

■ **Note** Although this software doesn't directly support USB printers (such as common inkjet printers), there is a work-around solution. It's possible to configure them to work using the APRINT6.EXE file included in the software download. The detailed instructions on how to accomplish this are at <http://keyhut.com/postip4.htm#program>.

---

After the software has been installed, it will need to be configured by entering product categories, setting up tax rates, stock table, how to print, etc. Launching the Pos Config (Figure 2-7) program allows you to make the necessary configurations so you can use the POS/Cash Register software to ring up sales.

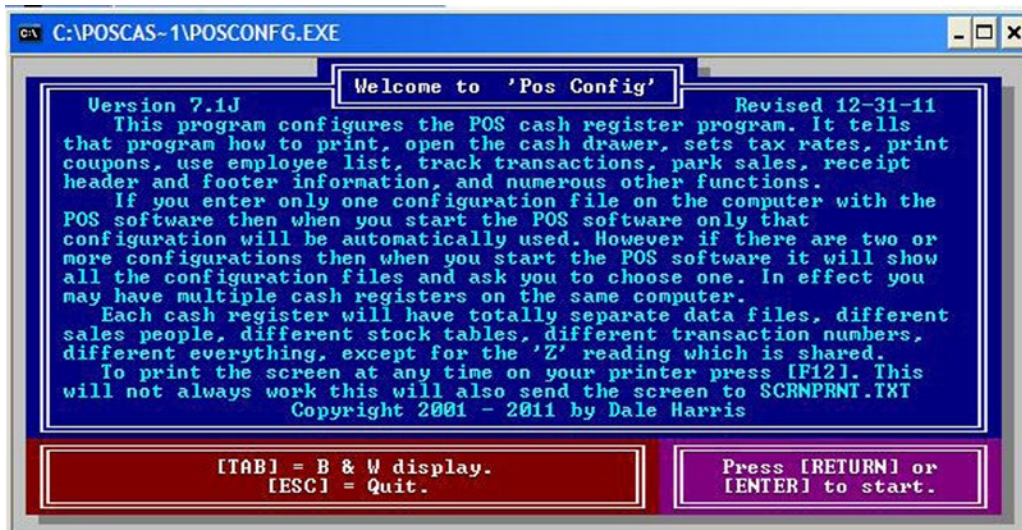

**Figure 2-7.** The Pos Config program is for inputting the parameters needed to use POS/Cash Register. (Used with permission © Dale Harris 2015)

As an option, this program keeps a journal of the daily transactions (including openings, closings, voids, etc.) on the disk as a text file. As the software's developer, Mr. Harris, points out on his website, "You may be legally required to make and store a journal of your register transactions. In addition it is a really good idea. The journal is your record of what was going on in your store. Was your register closed out at mid-day? Was that large void total from one transaction or many? How about all those refunds? Your journal will give you those answers." I can further attest to this from my own many years of experience in retail, prior to going into business for myself in 2000.

The journal can be configured to clear and reset at the beginning of each day (just make sure you've printed or archived the previous day's journal) or to keep a record of transactions on an ongoing basis. When needed, the journal can be placed into a Word processing program (such as LibreOffice or OpenOffice) and printed out (Figure 2-8).

```

T1 1 0 TEST RECEIPT
    at 50.00ea. 50.00
-----
1
    SUB TOTAL 50.00
TAX1 at 7.000% 3.50
    TOTAL TAX 3.50
    TOTAL 53.50
-----
    CASH TENDERED 100.00
    CHANGE DUE 46.50
    05-22-2015
-----
OPEN OPEN OPEN OPEN OPEN
TRAN = 0044 05-23-2015 12:20
-----
TX1 7.000% 52.71 0.000% 0.00
    TOTAL 52.71 TOTAL 0.00
    TOTAL TAX: 52.71
-----
    CASH SALE: 753.00 17
    CHECK SALE: 0.00 0
    CREDIT SALE: 0.00 0
    DEBIT SALE: 0.00 0
GIFT CARD SALE: 0.00 0
    SALE: 0.00 0
    CASH RETURN: 0.00 0
    CHECK RETURN: 0.00 0
    CREDIT RETURN: 0.00 0
    DEBIT RETURN: 0.00 0
GIFT CARD RETURN: 0.00 0
    RTRN: 0.00 0
    NET SALES: 753.00
    TOTAL TAX: 52.71
    GROSS SALES: 805.71
    TIPS: 0.00
    CASH BACK: 0.00
    SUB REG CASH: 805.71
    
```

*Figure 2-8. A journal of all transactions is kept as a text file on the disk. (Used with permission © Dale Harris 2015)*

## POS/Cash Register Support

If you have experience in working with DOS-based POS systems, you'll probably be able to use this software with relative ease. If it seems overwhelming, take the time to read over the website carefully, particularly the FAQ page and the the online User's Manual (<http://keyhut.com/posmenu.htm>).

At the of writing, there's very little in the way of tutorials on YouTube (one on setting up a pole display). However, there is a POS forum where questions are posted and answered (Figure 2-9).

The screenshot shows the phpBB forum interface for Dale Harris Educational Software (DHES). The header includes the site logo, a search bar, and navigation links. The main content area displays a table of forum categories:

GENERAL	TOPICS	POSTS	LAST POST
<b>Dale Harris Educational Software</b> Make comments, ask questions, or just complain about the software on this site. Or comment on any educational software. Please note that by clicking on links that may appear in these posts that you may be leaving the Dale Harris Educational Software website and that the content of those sites is the sole responsibility of the authors of those sites. Moderators: Alan, <b>Andrew</b> , <b>daleadmin</b> , Dale Harris	1781	9770	by brucef2112 Tue May 19, 2015 8:43 pm
OTHER TOPICS	TOPICS	POSTS	LAST POST
<b>Dale Harris News Forum</b> This is an archived forum, creating new posts isn't permitted. It was formerly used as a place to discuss news about DHPOS but that is now done in the main forum. Moderators: <b>Andrew</b> , <b>daleadmin</b>	5	24	by <b>Andrew</b> Sat Mar 22, 2008 2:40 am
<b>POS vendors</b> Business to Business forum: offer your wares here. You can offer up whatever it is your business has to offer as long as it would appeal to small businesses. Disclaimer: we have not tested or verified the products of anyone who posts here, this is simply for informational purposes. Buyer beware. Moderators: <b>Andrew</b> , <b>daleadmin</b>	68	267	by <b>daleadmin</b> Thu Aug 22, 2013 10:03 pm
<b>Off-Topic</b> For any non-pos posts you wish to post. Moderators: Alan, <b>Andrew</b> , <b>daleadmin</b>	119	519	by Dukane Sun May 24, 2015 9:25 am

**Figure 2-9.** The POS Forum is one source of support. (Used with permission © Dale Harris 2015)

■ **Note** A few other free POS solutions are briefly looked at in the “Additional Software Titles” section of the Appendix.

## Insightly: A Free, Easy-to-Use CRM Application

CRM, or *customer relationship management*, is an important aspect of any business. CRM is essentially a system of keeping track of customers, projects, tasks, opportunities, and schedules. The free version of Insightly is an easy-to-use CRM tool perfect for small businesses. It's free for up to two users, which is ideal for the one- or two-person startup business.

Here are a few facts about Insightly at a glance:

- **Alternative to:** SugarCRM
- **Website:** [www.insightly.com](http://www.insightly.com)
- **License:** Proprietary Freeware (for up to two users)
- **Current Version:** Not Specified
- **Operating Systems:** Web-based/Cross-platform
- **Potential Savings:** \$40.00 per month

After signing up, you can add tasks, contacts, organizations, and everything else needed to start using Insightly (Figure 2-10).

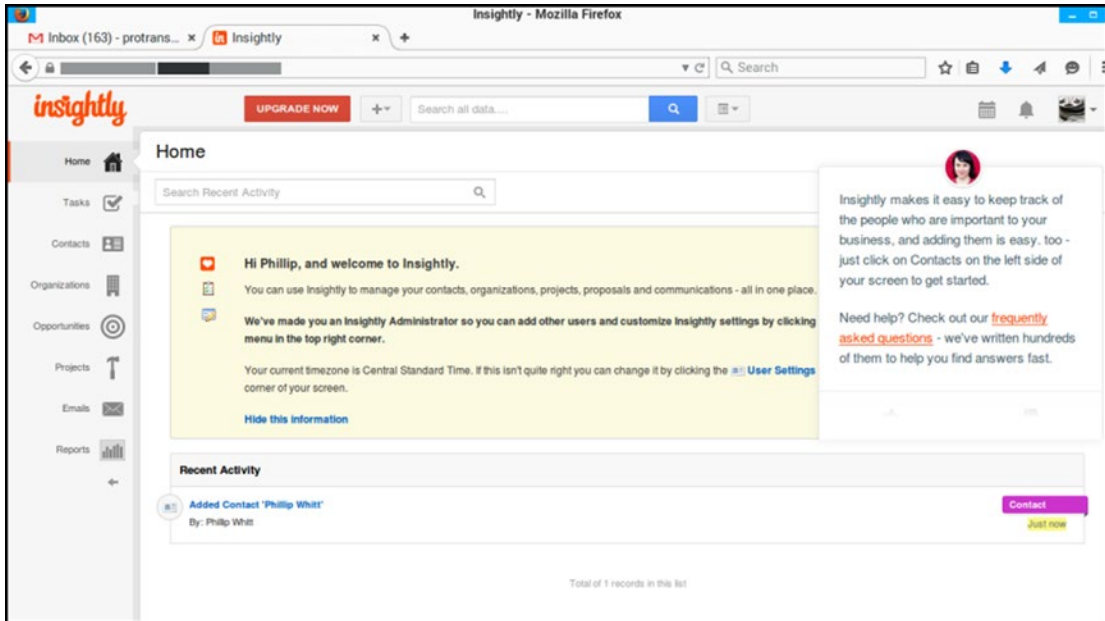

Figure 2-10. Insightly can be ready to use up after signing up. (Used with permission © Insightly, Inc. 2015)

## Feature Highlights

Even though the free version of this CRM program has several limitations, it does have a number of features that make Insightly a valuable asset for juggling all the information you need to serve your clientele more effectively. Here are several features:

- Create and manage tasks and projects
- Synchronize with Gmail
- Create new business opportunities
- Add important dates

When adding contacts, you can include all of the pertinent information such as e-mail addresses, phone numbers, websites, and other forms of contact information. Additional information, such as important dates (birthdays, anniversaries, etc.) can also be added (Figure 2-11).

**Figure 2-11.** You can add relevant contact information and important dates for your customers. (Used with permission © Insightly, Inc. 2015)

---

■ **Note** Collecting significant dates is important for maintaining a good business relationship with your customers, and it is an important element of CRM. When you reach out to your customer with an appropriate birthday or anniversary card (or any meaningful event), it has a lot of impact.

---

Starting and managing projects is another vital feature of Insightly (Figure 2-12). Using this function, the project's details are listed, starting and finishing times are assigned, and links can be added. The status of the project can be changed any time.

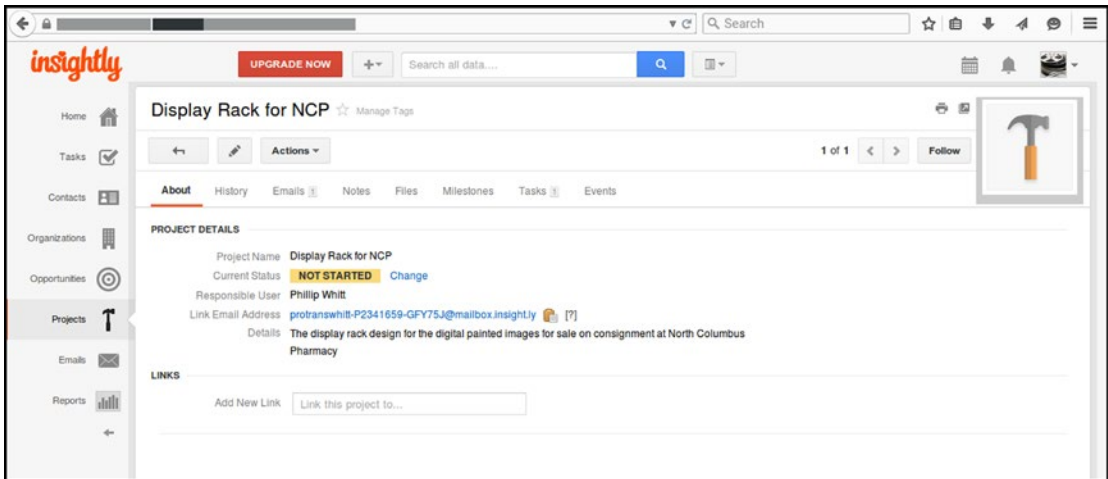

Figure 2-12. Retain all of the important details of your projects. (Used with permission © Insightly, Inc. 2015)

## Insightly Support

Insightly has an ample system of learning support in the form of an FAQ page and a library of tutorial videos (Figure 2-13). Because Insightly seems to be quite popular, there is no shortage of useful videos on YouTube. You can also find support on the Insightly Support page at <http://support.insightly.ly/hc/en-us>.

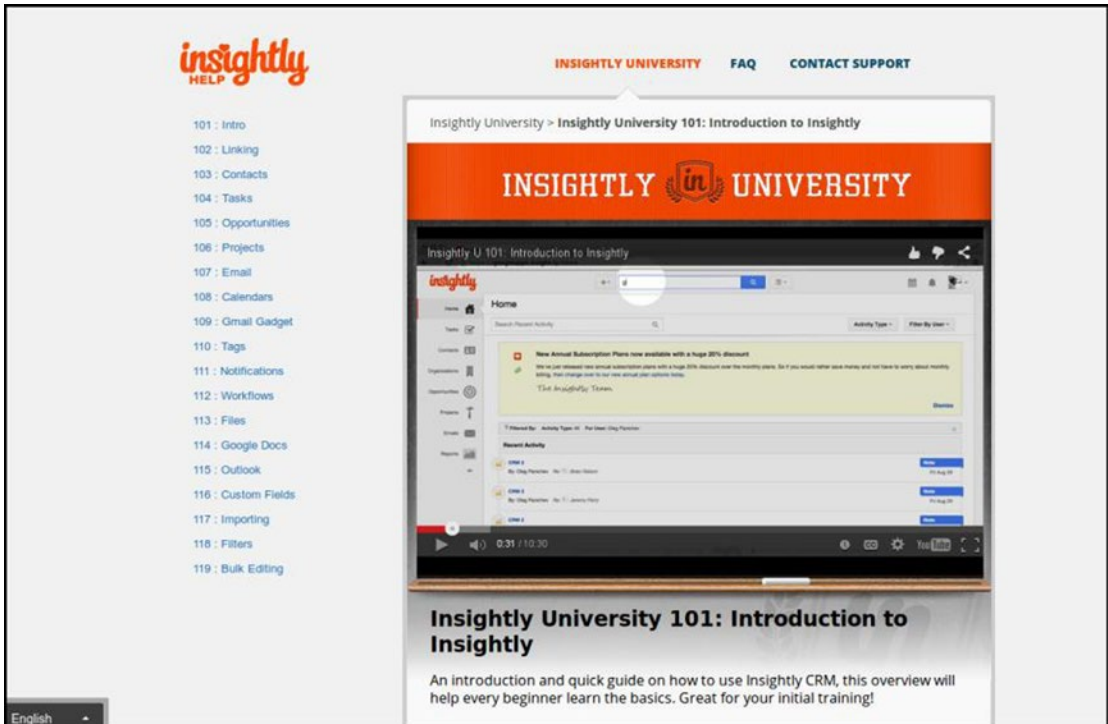

Figure 2-13. Insightly University is a library of tutorial videos. (Used with permission © Insightly, Inc. 2015)

## Bitrix24: A Social Intranet, CRM Solution For Small Business

Bitrix24 describes itself as a social intranet, task management, and CRM solution. The cloud version is free for up to 12 users, making it a viable option for small companies that are a little larger than a one- or two-person enterprise. There are paid, self-hosted versions of Bitrix24 designed for larger companies.

Here are a few facts about Bitrix24 at a glance:

- **Alternative to:** SugarCRM
- **Website:** [www.bitrix24.com](http://www.bitrix24.com)
- **License:** Proprietary Freeware
- **Current Version:** Not Specified
- **Operating Systems:** Web-based/Cross-platform
- **Potential Savings:** \$39.00 (Single User)

### Feature Highlights

Like Insightly, Bitrix24 offers the ability to manage important data connected to your company and to collaborate with your colleagues. Here is a list of some of the features Bitrix24 has to offer:

- Create and manage tasks
- Synchronize with Gmail
- Create opportunities
- Add important dates

Bitrix24 offers the elements of a social media platform (Figure 2-14). Company personnel can set up user profiles with contact information, general personal information, and additional information such as skills and interests. It combines a social intranet system with CRM tools that include contact tracking, sales funnel management, messaging, activity planning, and calendars.

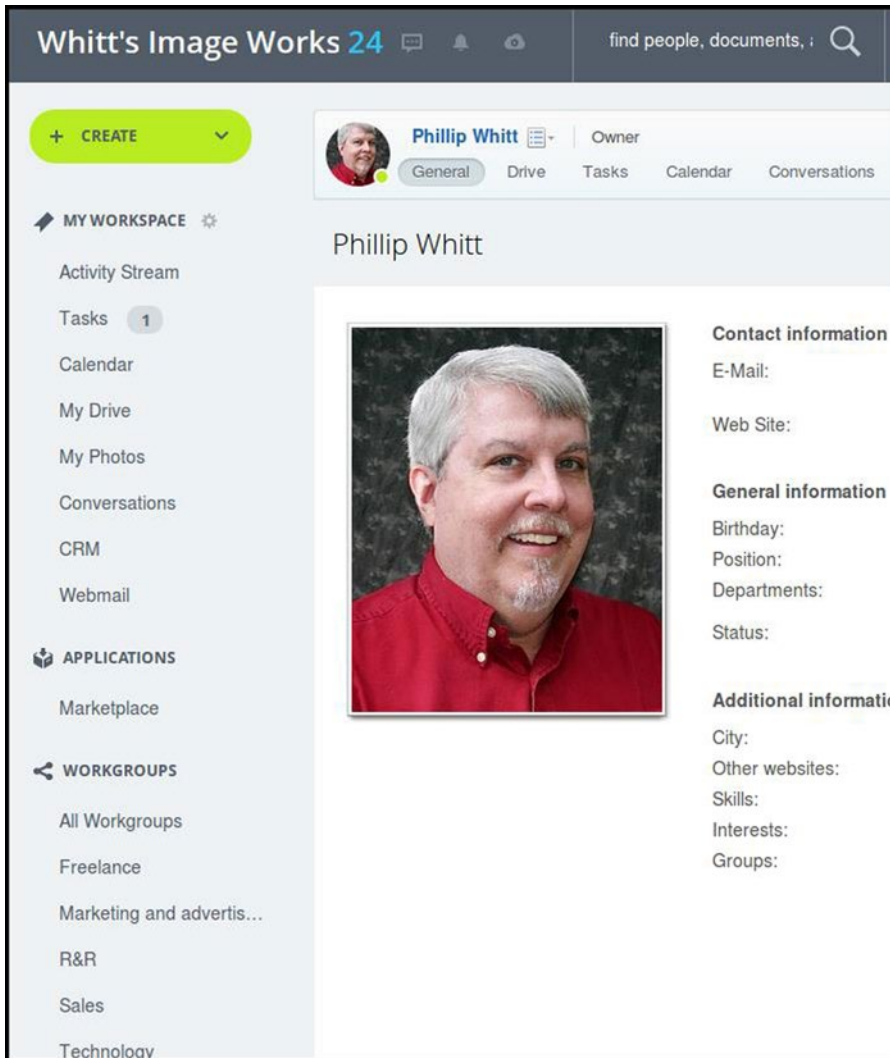

**Figure 2-14.** Bitrix24 has elements of a social media platform. (Used with permission © Bitrix, Inc. 2015)

Tasks can be created and managed in Bitrix24 (Figure 2-15). The *Time Tracker* records the time it took to handle the project, and can be started and stopped as needed. Tasks can be prioritized, delegated, edited, postponed, or deleted.

The screenshot displays the Bitrix24 task management interface. At the top, the user is identified as Phillip Whitt. The main task is titled "Marketing Postcards for Bright Images (task #6)". The task description reads: "Design postcards to market film to video transfer services for Bright Images. These will be mailed to prospects in Lynchburg in batches of 100 per month." A checklist and tags section are visible below the description. A time tracker is active, showing a time of 00:00:22 / 06:00. The right sidebar provides detailed information about the task, including the creator (Phillip Whitt), responsible person (Phillip Whitt), status (In Progress), priority (Normal), and deadline (05/30/2015 11:00:00 pm). The interface also includes a left sidebar with navigation options like "MY WORKSPACE" and "APPLICATIONS".

**Figure 2-15.** Bitrix24 has elements of a social media platform. (Used with permission © Bitrix, Inc. 2015)

By using the *CalDav* feature, Bitrix24 can synchronize with Google Calender, so the Events you create there will appear on the calender within Bitrix24 (Figure 2-16). The calender will also connect to other calendars on mobile devices and to Outlook.

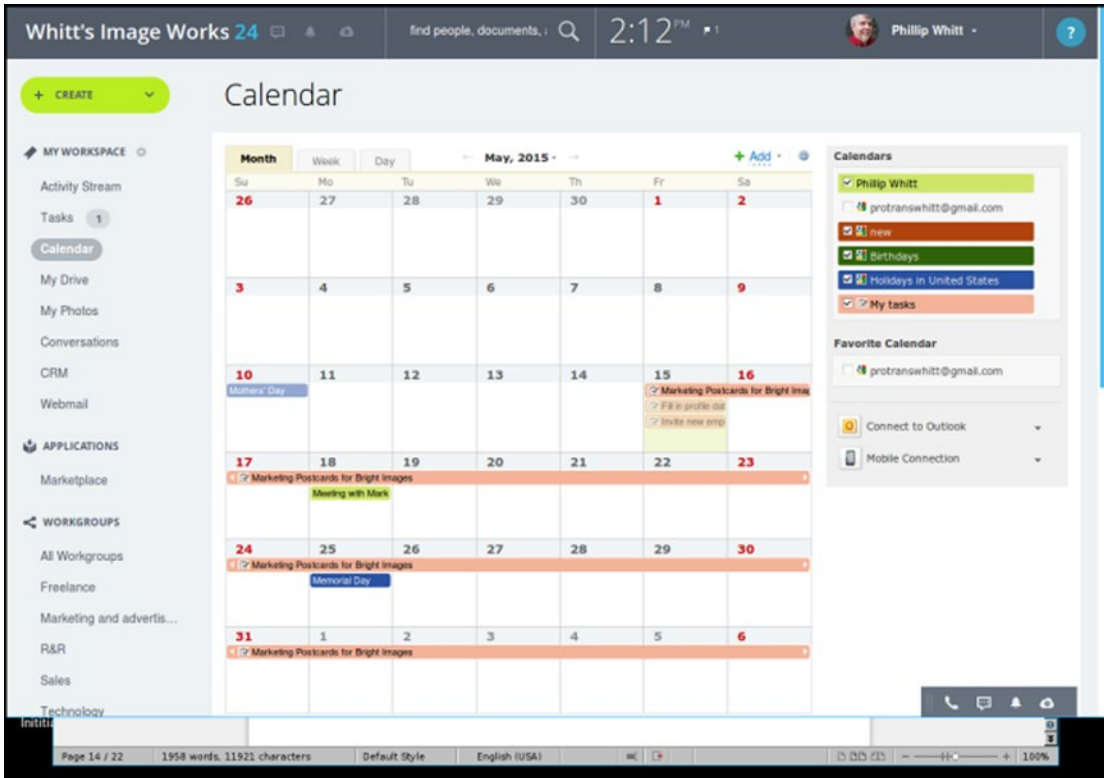

**Figure 2-16.** The calender can synchronize with Google Calender, calenders on mobile devices, and Outlook. (Used with permission © Bitrix, Inc. 2015)

*My Drive* (Figure 2-17) in the free version of Bitrix24 provides you with 5GB of free storage; there are charges for additional drive space.

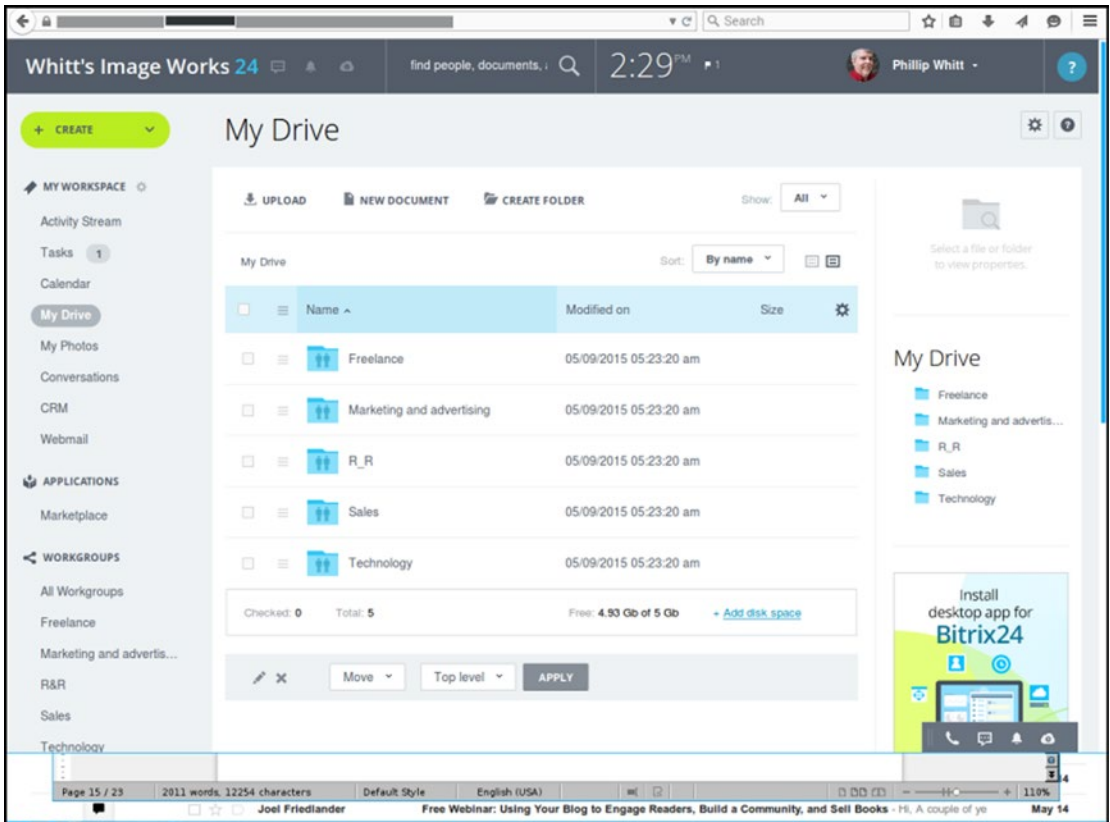

**Figure 2-17.** The Bitrix24 My Drive provides 5GB of free storage. (Used with permission © Bitrix, Inc. 2015)

---

■ **Note** If you're especially frugal, you can store most of your files (up to 15GB) in Google Drive for free, and the others in Bitrix24's My Drive.

---

## Bitrix24 Support

The Support24 page (under the Help tab) provides many answers to common questions (Figure 2-18). If you can't find the answer here, there's a good chance you can find a tutorial video on YouTube that covers the topic in question.

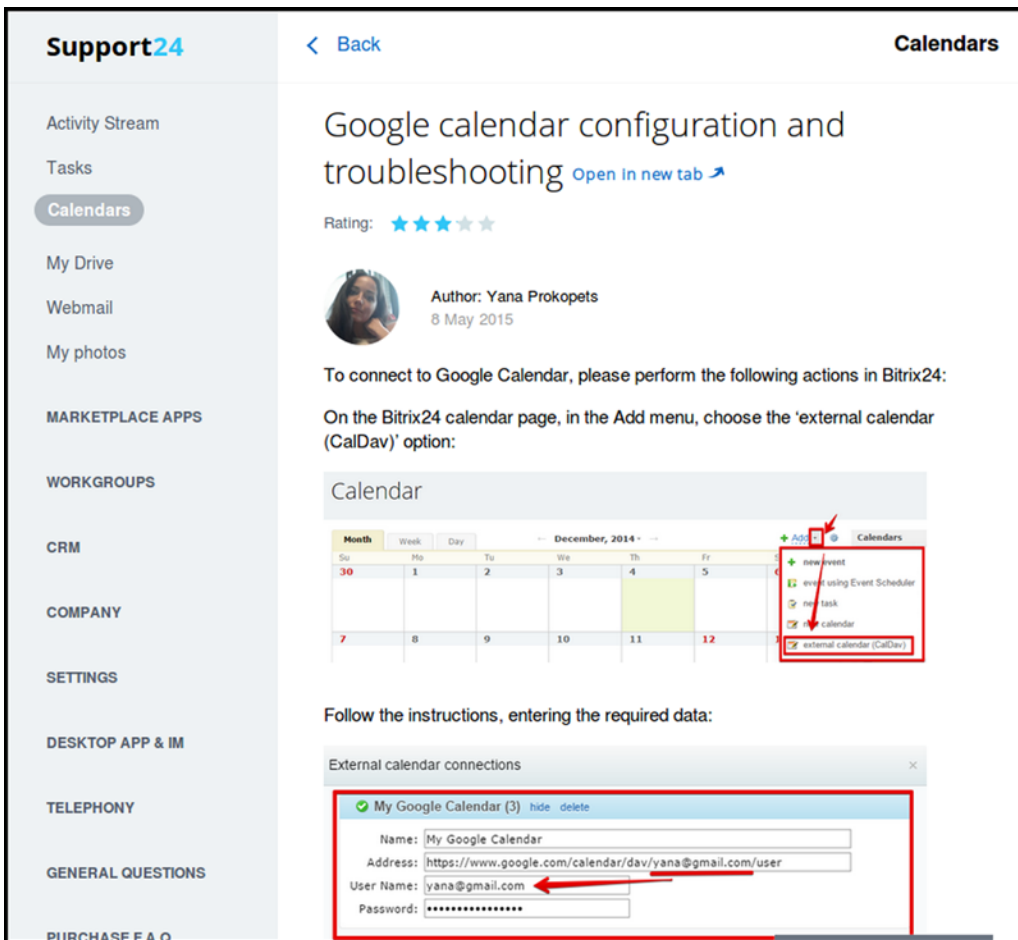

Figure 2-18. Support24 answers many common questions. (Used with permission © Bitrix, Inc. 2015)

## FBackup: A Free Basic Backup Utility

We all know that protecting the data on your computer is very important; a hard drive crash or other unforeseen circumstances can effectively wipe out untold hours of hard work if the data hasn't been backed up. But it's easy to forget to back up your files on a regular basis. Fbackup is a free backup program that will help make this task easier.

Here are a few facts about FBackup at a glance:

- **Alternative to:** Nova BACKUP PC
- **Website:** [www.fbackup.com](http://www.fbackup.com)
- **License:** Proprietary Freeware
- **Current Version:** 5.4.784
- **Operating Systems:** Windows
- **Potential Savings:** \$49.95

## Feature Highlights

FBackup has a number of nice features for a free program. The detailed list of highlights can be viewed on the website. Here's the quick overview:

- Free for both personal and commercial use
- Set it to run automatically
- Back up with standard zip compression
- Exact copies of files
- Easy to use
- Run actions before/after backup
- Automatic updates
- Multiple backup destinations
- Backup plugins
- Back up open files
- Multi-language

Upon opening FBackup, you will be presented with a *Getting Started* menu (Figure 2-19). It offers the options of creating a new backup job, restoring the files from a previous backup session, links to video tutorials, and links to various tasks.

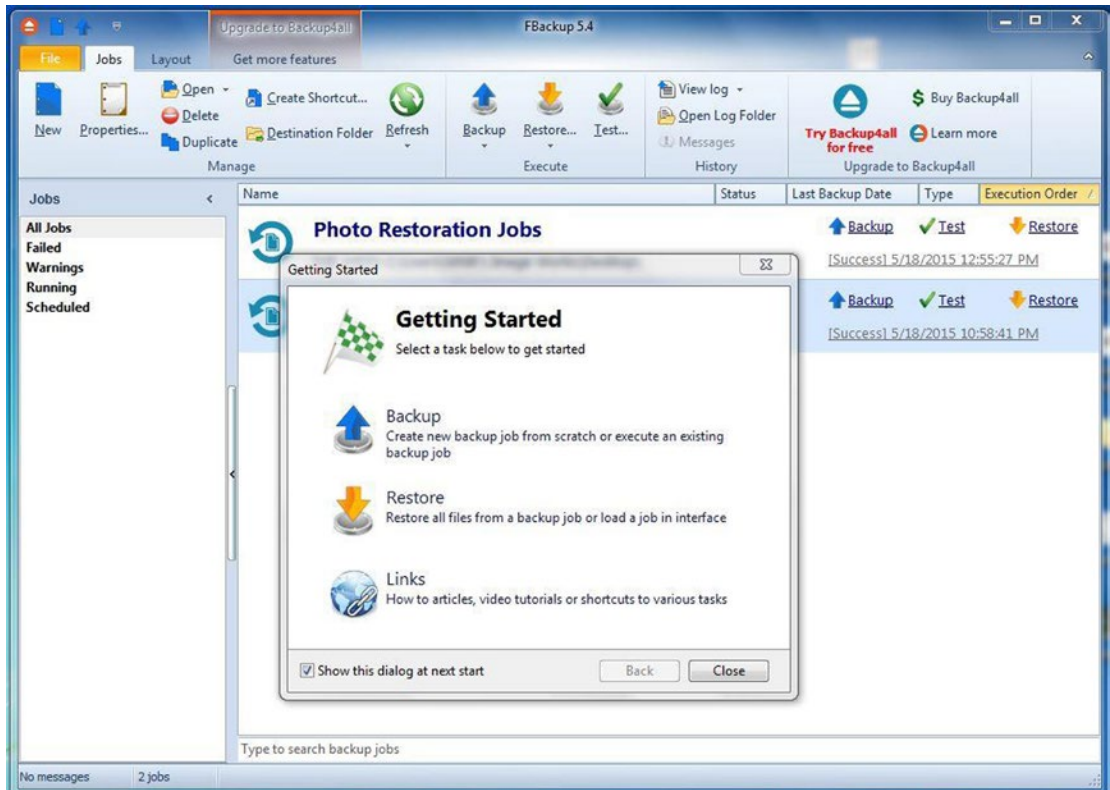

**Figure 2-19.** The Getting Started menu in FBackup (Used with permission © Softland 2015)

You can navigate to the file(s) or folder you want to back up. Figure 2-20 shows a folder that contains various documents, images, and video files I work with on a regular basis (and can't risk losing).

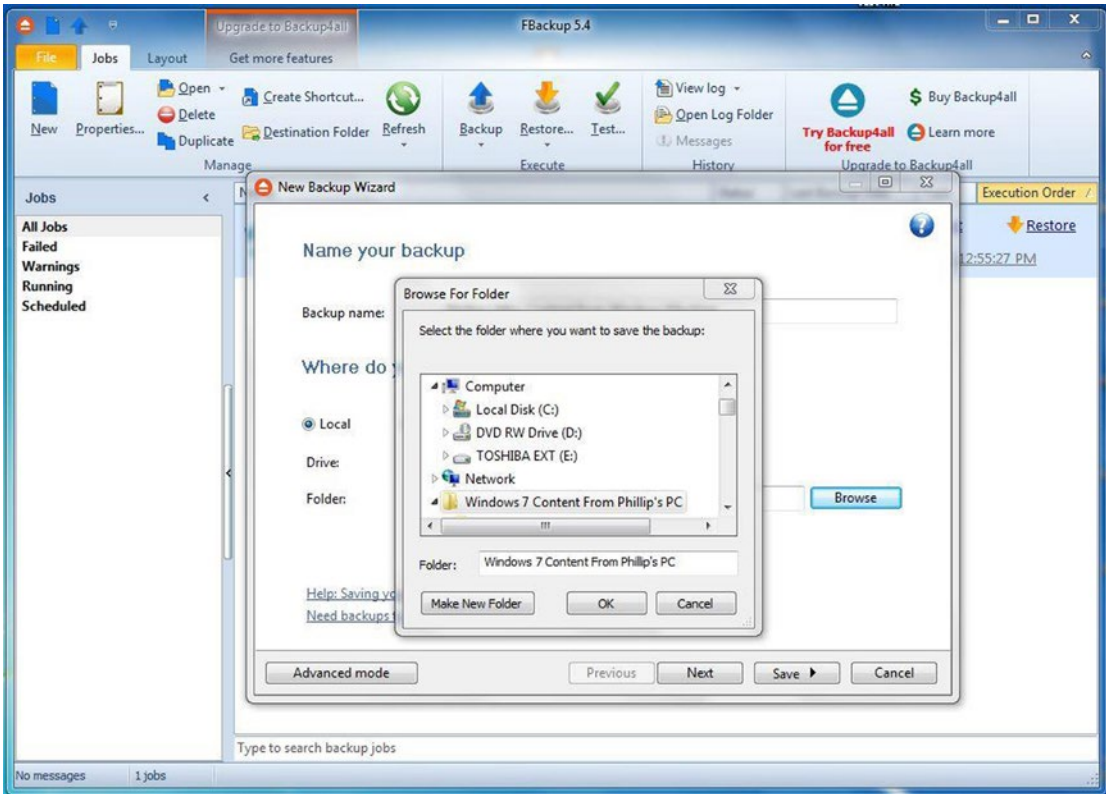
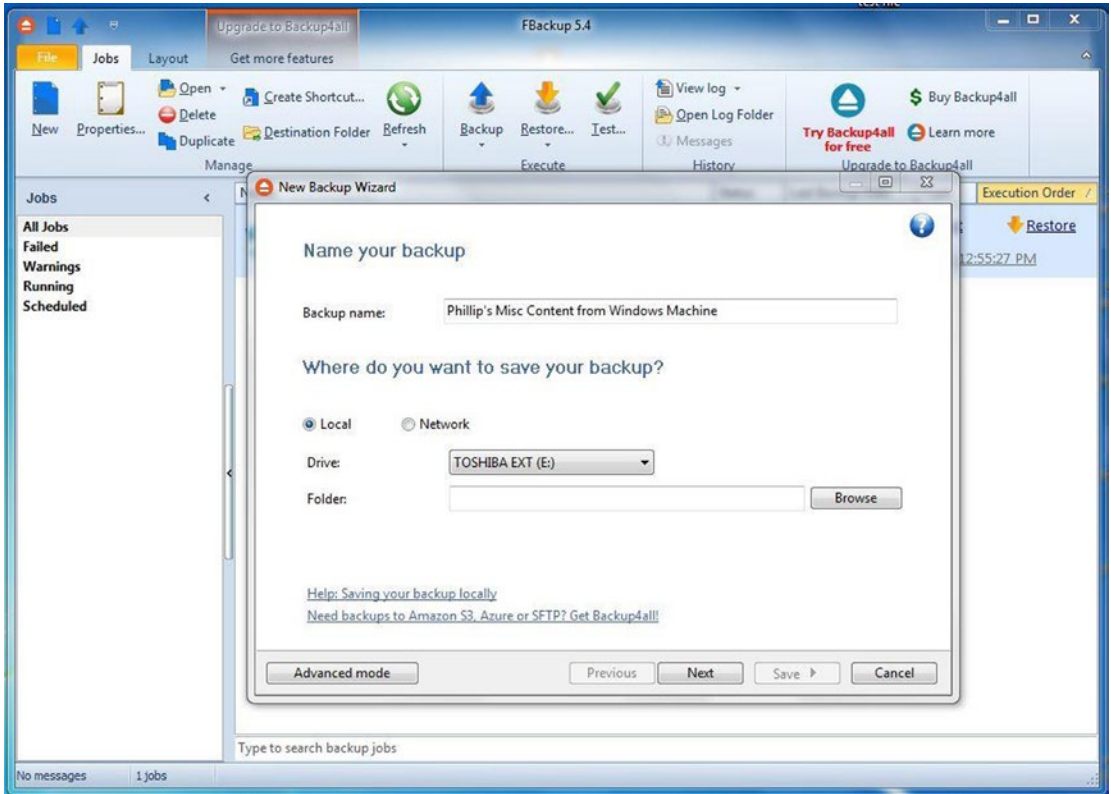

Figure 2-20. Navigating to the folder to be backed up (Used with permission © Softland 2015)

Now that the folder is ready to be backed up, an external hard drive is selected as the destination for the data to be saved. There are options for backing up data to DVD, a local drive, or (if your computer is on one) a network (Figure 2-21).



**Figure 2-21.** Backed up data can be saved to a local drive or a network. (Used with permission © Softland 2015)

FBackup offers the options of performing your backups manually as needed, or it can be set up to work automatically on a daily, weekly, or monthly basis (Figure 2-22).

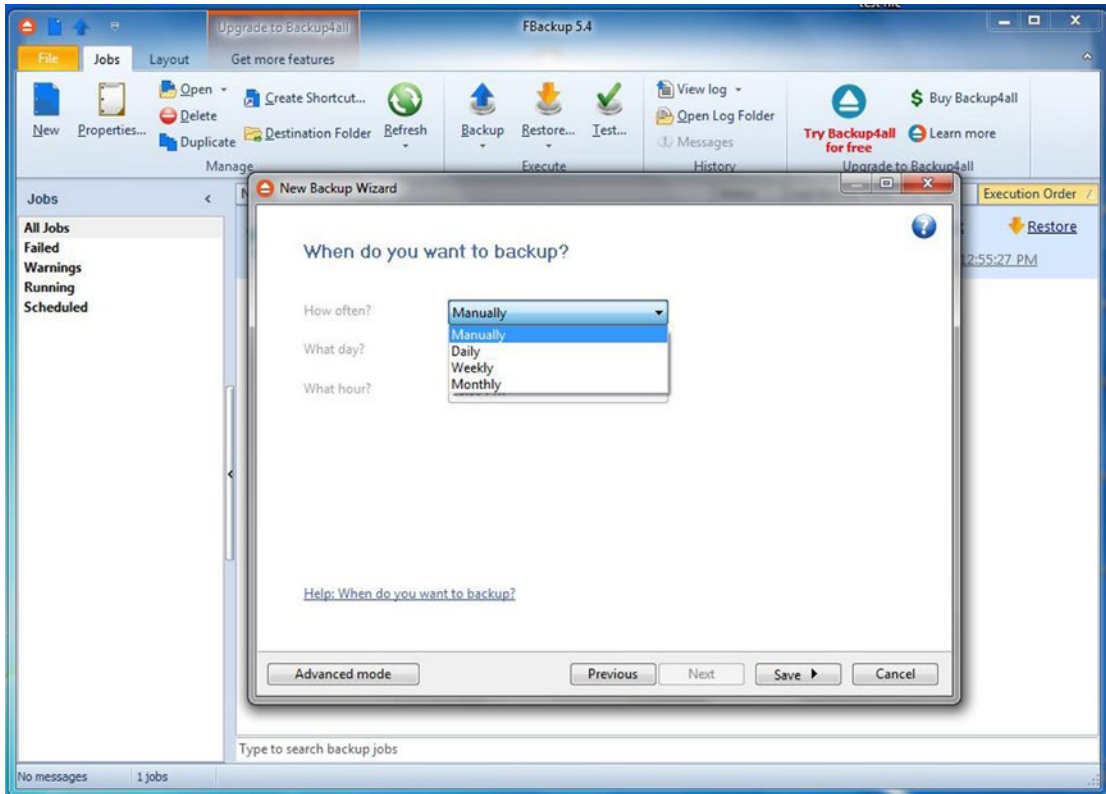

**Figure 2-22.** FBackup can be controlled manually, or set to run automatically daily, weekly, or monthly. (Used with permission © Softland 2015)

## FBackup Support

The Help tab on the website links to the FBackup Forum, where new users can read announcements, post general questions, access tutorials, and find trouble-shooting tips. There are a few tutorials on YouTube that can be helpful as well.

This software isn't really terribly complicated to use, but new users may want to download the PDF User Manual from [download.fbackup.com/download/pdf/User-Manual.pdf](http://download.fbackup.com/download/pdf/User-Manual.pdf).

## 7Zip: An Open Source Alternative to WinZip

7Zip is a very useful free program for extracting .zip files (among other formats), as well as creating compressed files and folders to aid in archiving, transporting via e-mail, or uploading to an FTP site.

Here are a few facts about 7Zip at a glance:

- **Alternative to:** WinZip
- **Website:** [www.7-zip.org/](http://www.7-zip.org/)

- **License:** Mixed-GNU LGPL + unRAR restriction
- **Current Version:** 9.20 (Beta version 9.38)
- **Operating System(s):** Widows (Beta variants available for Mac OS and Linux)
- **Potential Savings:** \$29.95 (WinZip Standard)

There are times when you need to transport large files and folders from one place to another. When they contain a lot of data, 7Zip is a handy tool for file compression that handles several formats, making the task a bit easier.

## Feature Highlights

There is a detailed list of 7Zip's features on the website, but here is a slightly abridged version:

- High compression ratio in the 7Z format
- Some of the supported formats for packing/unpacking are 7Z, XZ, BZIP2, GZIP, TAR, ZIP and WIM.
- Unpacks a wide variety of formats
- For ZIP and GZIP formats, 7-Zip provides a compression ratio that is 2-10 % better than the ratio provided by PKZip and WinZip.
- Strong AES-256 encryption in 7z and ZIP formats
- Self-extracting capability for 7z format
- Integration with Windows Shell
- Powerful File Manager

For example, 7Zip offers the ability to compress layered Photoshop (.PSD) or GIMP (.XCF) files. In Figure 2-23, you can see a folder that contains several layered GIMP .XCF files that total just over 92MB. As more and more folders containing layered images accumulate over time, they eventually take up lots of valuable hard drive space.

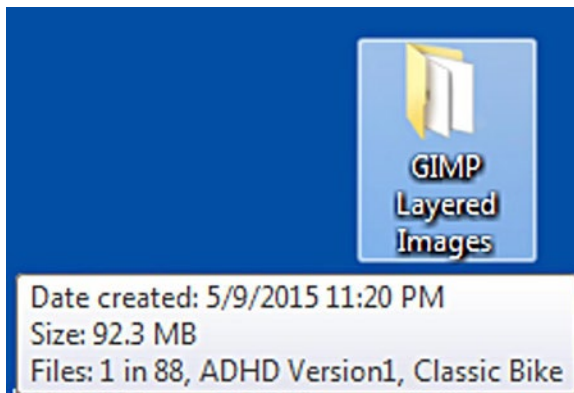

**Figure 2-23.** A folder containing layered GIMP files at almost 93MB (Used with permission © Igor Pavlov 2015)

Creating a compressed .ZIP folder is a matter of right-clicking the folder, navigating to 7Zip, and selecting the *Add to archive* option (Figure 2-24).

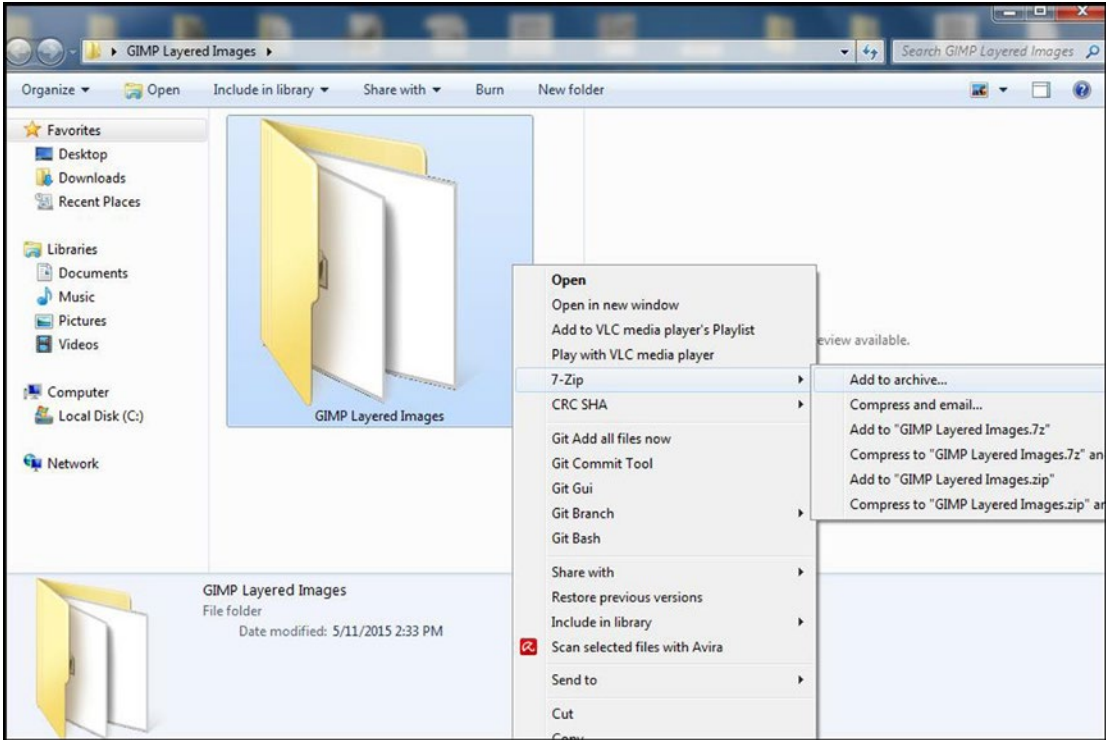

**Figure 2-24.** Accessing the *Add to Archive* option through the drop-down menu (used with permission © Igor Pavlov 2015)

A dialog box opens with numerous options such as Archive format, compression level, and compression method, to name a few (Figure 2-25). There is also an option to encrypt the file, requiring a password to open.

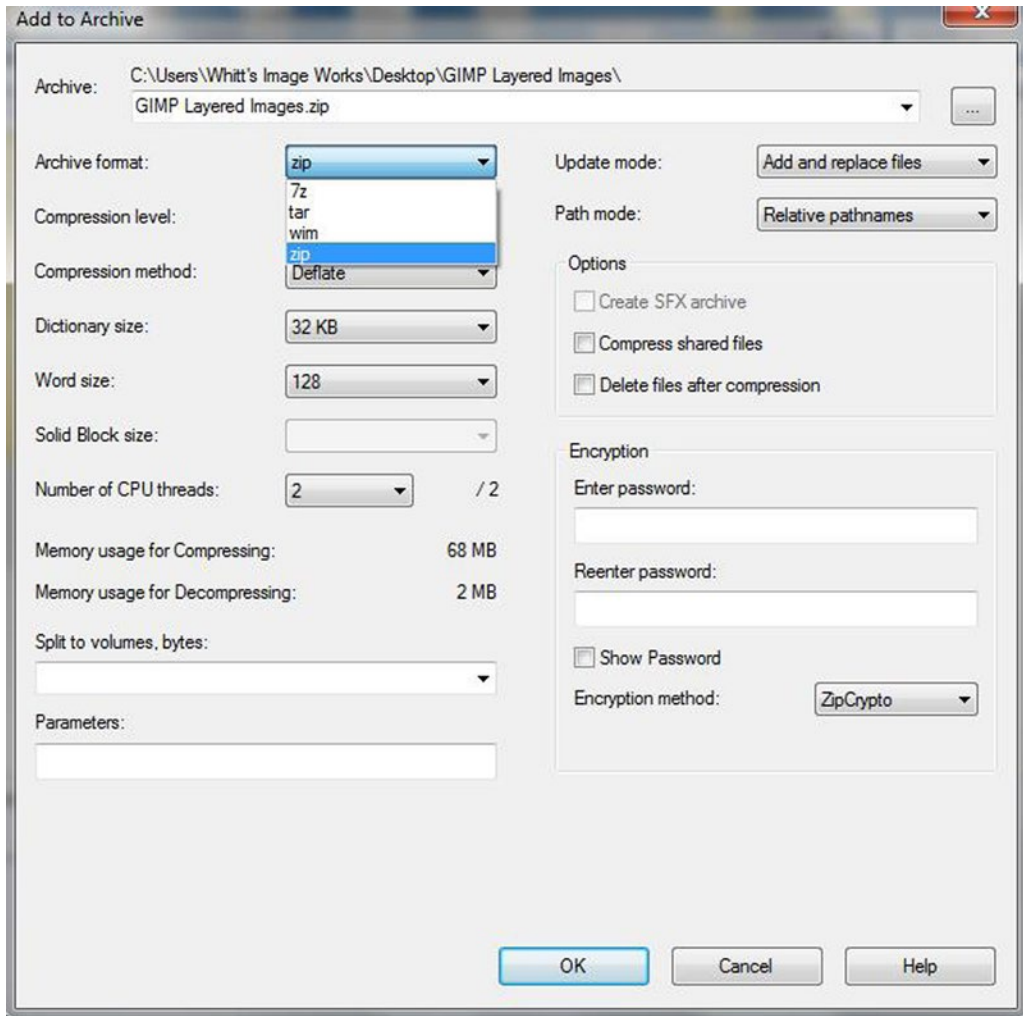

**Figure 2-25.** The Add to Archive dialog box (Used with permission © Igor Pavlov 2015)

A zipped folder containing the layered GIMP .XCF files is created, and at just over 45MB, it is less than half the size of the original folder (Figure 2-26).

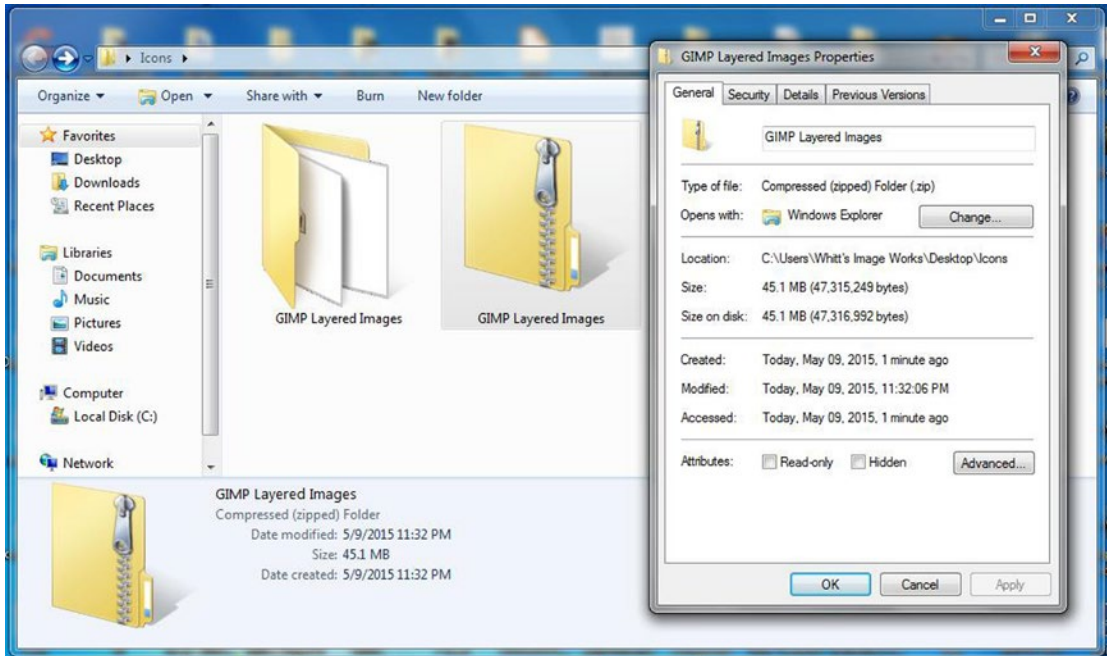

**Figure 2-26.** The Add to Archive dialog box (Used with permission © Igor Pavlov 2015)

## 7Zip Support

The website has a support page (Figure 2-27) with a keyword search feature that lists the related topics in the *7Zip Forum*. The FAQ page is quite helpful. There are also a handful of instructional videos on YouTube, most of which cover the installation of 7Zip.

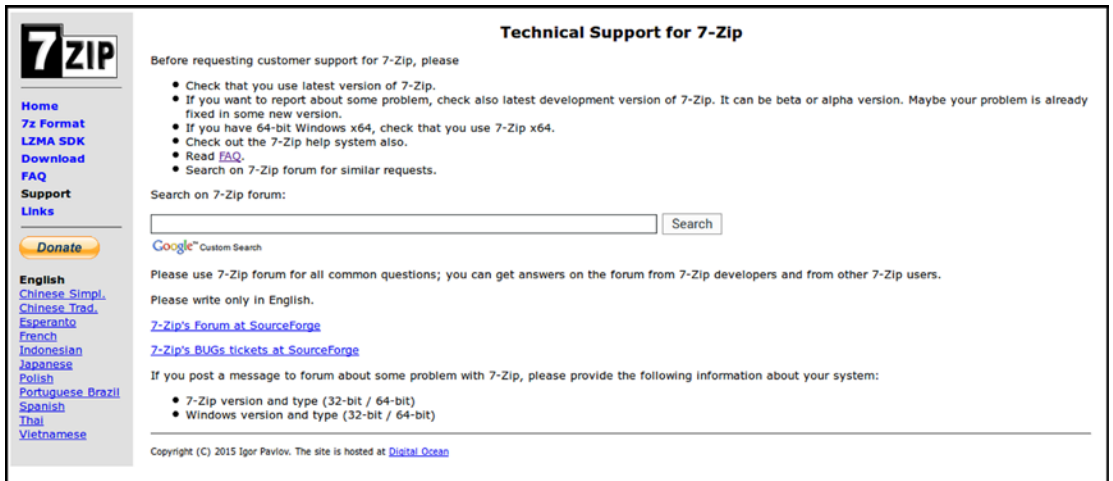

**Figure 2-27.** The keyword search feature aids in finding help on the 7Zip Forum. (Used with permission © Igor Pavlov 2015)

There is also a two-page PDF User Guide that can be downloaded from [www.gla.ac.uk/media/media\\_172585\\_en.pdf](http://www.gla.ac.uk/media/media_172585_en.pdf).

## Summary

This chapter looked at two no-cost, point-of-sale systems. Imonggo's free version is ideal for the small shop or boutique, and POS/Cash Register is a DOS software program that can turn old PCs into functioning cash registers. Additional free POS systems are briefly looked at in the "Additional Software Titles" section of the Appendix.

Next, you looked at two free customer relationship management systems. Insightly is an easy-to-use system for up to two users (great for small start-ups). Bitrix24 is a CRM intranet system designed to function like a social media platform; free for up to 12 users, it helps colleagues collaborate on projects, coordinate meetings, and stay connected.

Lastly, you learned about two free Windows programs for data backup and archival needs. Fbackup is a free program for backing up important data, and 7Zip is a compression tool for file and folder archives that saves in several file formats, including the .zip format.

In the next chapter, you'll look at several free solutions for desktop publishing, vector drawing/illustration, and 3D rendering.

## CHAPTER 3



# Desktop Publishing, Illustration, Painting, and 3D Modeling Software

Imagine the local print shop quotes you twice the amount you envisioned spending on the marketing materials you plan to use to announce your Grand Opening. Having marketing materials such as brochures, business cards, and flyers designed (the expensive part of the process) and printed can cut into the budget. As a business owner, wouldn't it be nice to have the means to create your own marketing materials without breaking the bank? This chapter looks at two free desktop publishing solutions that can aid in creating your own marketing materials (such as postcards, brochures, and newsletters). If you don't need (or want) to go the route of Adobe InDesign, Microsoft Publisher, or QuarkXpress, these solutions can be perfect for small businesses with tight marketing budgets.

For creating graphic designs, there are no-cost solutions for vector illustrations and digital artwork. For the budget-minded engineer and animator, two 3D modeling programs are covered here.

Here's a quick look at the programs covered in this chapter:

- **Serif PagePlus Starter Edition:** A desktop publishing program that's limited in function, but easy to use
- **Scribus:** A powerful, professional-level, open source desktop publishing program for creating anything from business cards to magazines
- **Serif DrawPlus Starter Edition:** An illustration program with limited functionality but is quite ideal for creating quick graphic designs
- **Inkscape:** A powerful, professional-level vector graphics creation tool capable of stunning illustrations
- **Krita:** A drawing and painting program for creating beautiful digital artwork
- **FreeCAD:** A powerful program for rendering 3D designs of everything from small machine parts to architecture
- **Blender:** A very powerful (and complex) open source program for creating stunning 3D animations

# Serif PagePlus Starter Edition: A Free, Easy-to-Use Desktop Publishing Program

Serif is a U.K.-based developer of inexpensive but very capable design software solutions. PagePlus Starter Edition is a free, slimmed down version of Serif's paid, full version of PagePlus (now in version X8), a desktop publishing program similar to Adobe InDesign. This starter edition lacks some of the advanced features, but if you are looking for a program to create brochures, postcards, and flyers with relative ease, then this might just be what you need.

## Here are a few facts about Serif PagePlus SE at a glance:

- **Alternative to:** Adobe InDesign, Microsoft Publisher
- **Website:** [www.serif.com](http://www.serif.com)
- **License:** Proprietary Freeware
- **Operating Systems:** Windows
- **Potential Savings:** \$19.99 per month (Adobe InDesign CC subscription)

The program can be downloaded from the Free Downloads page of the website. You'll be prompted to set up an account with Serif by submitting your e-mail and creating a password (you won't be required to submit any financial information). Serif will furnish a product key number by e-mail that is required for installing the software (so make sure you keep it in a safe place).

## Feature Highlights

Here's the quick run-down of the PagePlus features as they're listed on the website:

- Stunning stationery is so simple
- Easy drag-and-drop designing
- Layouts in a couple of clicks
- Precise and easy design tools
- Versatile desktop publishing
- Help is always on hand

## Design Capabilities

PagePlus SE employs an number of predesigned theme layouts (Figure 3-1) that make document creation easy, although you can create documents from scratch if you wish. The themes are a distinct advantage for business owners who want to create marketing materials but lack previous page layout experience.



**Figure 3-1.** Theme layouts in PagePlus SE make document creation fast and easy

In addition to theme layouts, PagePlus SE offers a limited selection of images such as photos and clip art. The postcard in Figure 3-2 was created in a matter of less than five minutes or so (choosing the font was the longest part of the process). The fonts menu will display the font in real time.

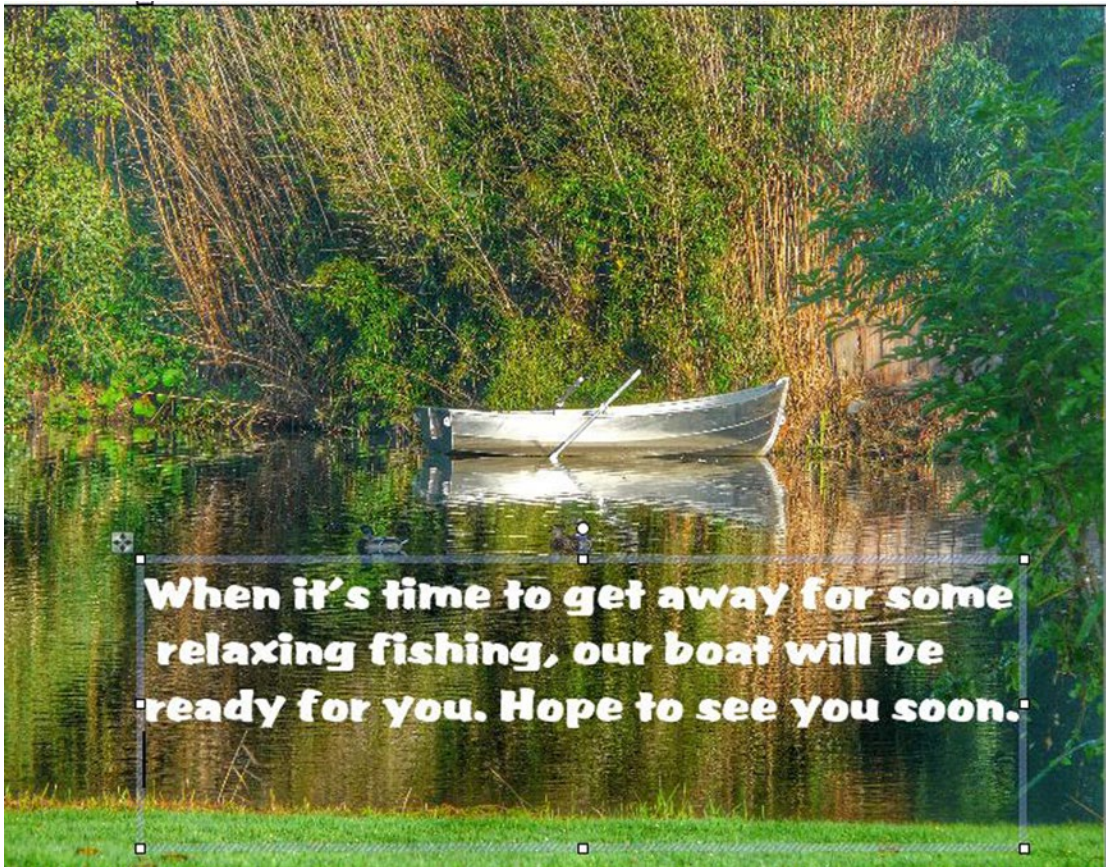

**Figure 3-2.** PagePlus SE offers a limited selection of images you can use in your documents, or you can use one of your own

With PagePlus SE, there are a few limitations worth noting: documents are limited to a maximum of five pages, exporting to PDF is disabled (although installing a program like PDF Redirect will work around that), and there are no color management features, image editing tools, or advanced text-handling abilities.

---

■ **Note** Serif Starter Edition programs do not indicate which features are disabled. When you try to access them, an upgrade offer window for the full version of the program will pop up. Some users will undoubtedly find this annoying, but you can simply close the window and continue working.

---

## PagePlus SE Support

There are quite a few video tutorials on YouTube and Serif's website. These videos apply to the full version of PagePlus, but they will help get you up and running with the Starter Edition in no time. You can also post questions in Serif's Community Plus forum.

# Scribus: The Powerful, Professional, Open Source Desktop Publishing Program

Scribus is an extremely capable program, but it has a steep learning curve for beginners. It was originally written for Linux, but is currently available for Mac OS X, OS2, and Windows. If you have experience with desktop publishing software such as Adobe InDesign or QuarkXpress, Scribus should be relatively easy to learn, but it does differ in some respects to these programs.

**Here are a few facts about Scribus at a glance:**

- **Alternative to:** Adobe InDesign, QuarkXpress
- **Website:** [wiki.scribus.net](http://wiki.scribus.net)
- **License:** GPL
- **Current Version:** 1.4.5
- **Operating Systems:** Windows, Mac OS, Linux
- **Potential Savings:** \$19.99 per month (Adobe InDesign CC subscription)

Scribus can help you create impressive documents, everything from business cards to magazines. *GIMP Magazine* is a great example, as mentioned in the Introduction. I use Scribus for creating my own marketing materials, such as two-panel pamphlets and flyers. Figure 3-3 shows a sample of the inside pages of a pamphlet I designed back in 2011 using Scribus.

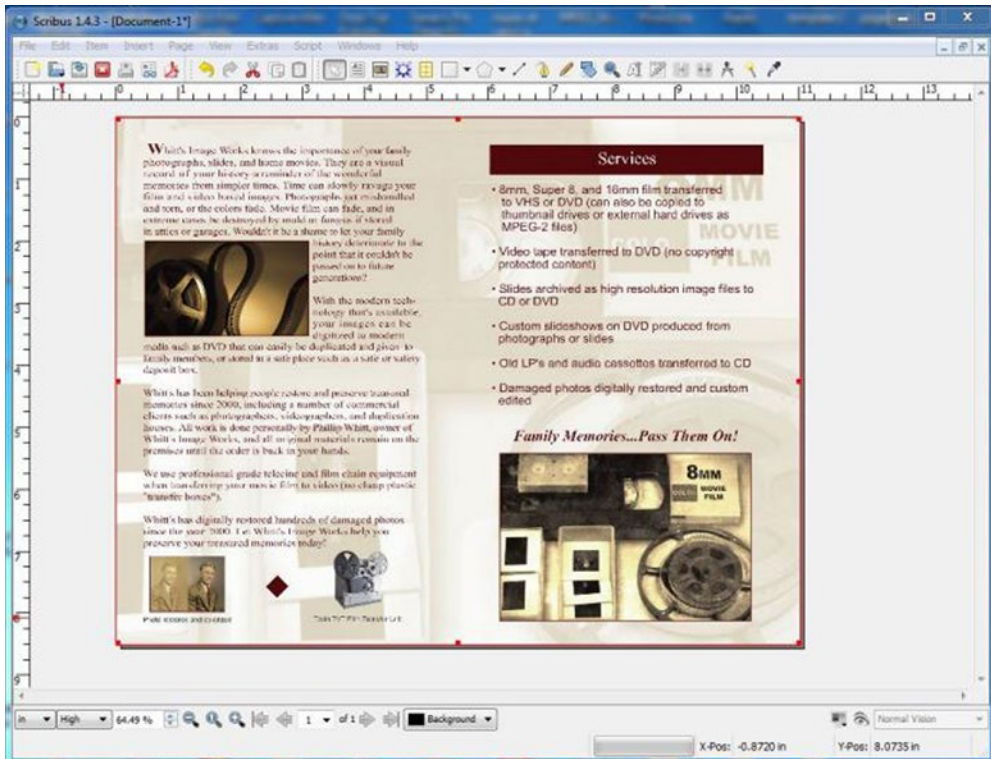

**Figure 3-3.** The inside pages of a pamphlet I designed using Scribus

## Feature Highlights

Scribus boasts a plethora of features that make this a professional-quality application. The following is just a quick rundown:

- CMYK colors
- Spot color support
- ICC color management
- Versatile PDF creation
- Vector drawing tools
- Emulation of color blindness

## Design Capabilities

Scribus is a pro-class application that allows the user to design documents (mainly) from scratch. Upon launch, you'll be presented with a dialog box to select the document type, page size, orientation, etc. Documents are created in Scribus by using frames for text and images (Figure 3-4); there are also design elements such as shapes and tools for creating vector-based images.

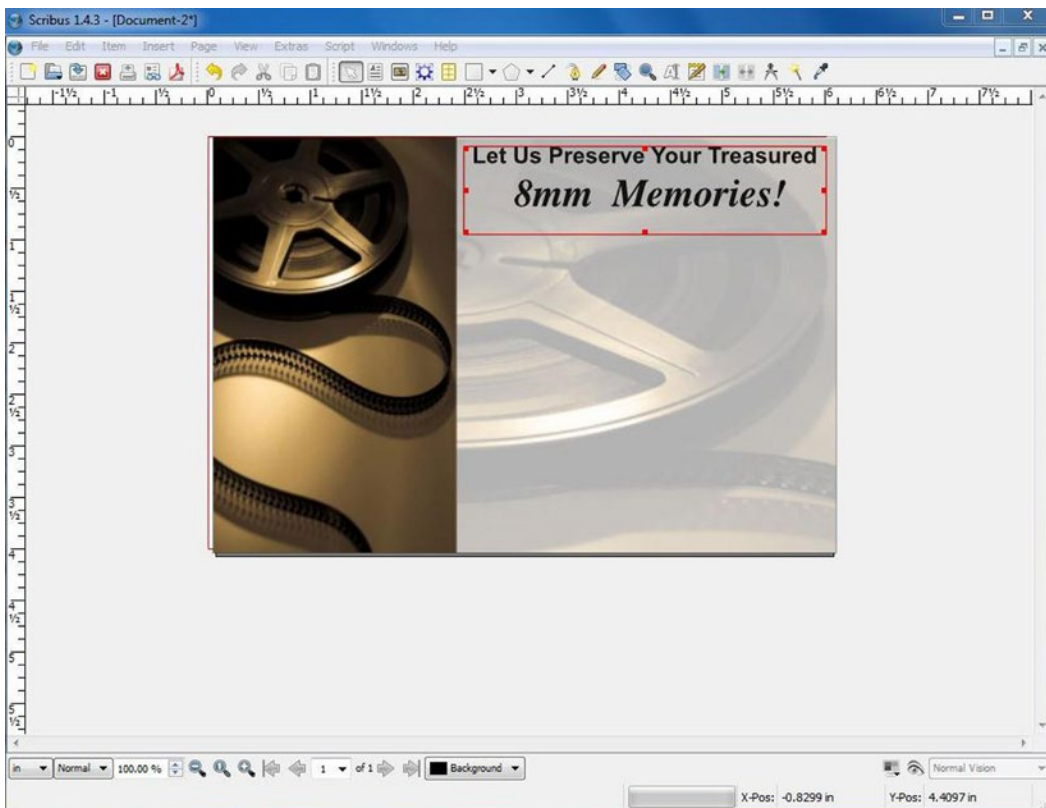

**Figure 3-4.** Scribus employs text and image frames for designing documents

---

■ **Note** Prior to installing Scribus, it's a good idea to install Ghostscript (an interpreter for PostScript and Encapsulated PostScript files) from [www.ghostscript.com](http://www.ghostscript.com). Although Scribus might work just fine without it, it is necessary to import EPS files and for the Print Preview to function.

---

For those that prefer not to build documents from the ground up, there are a wide variety of predesigned templates available from [www.scribusstuff.org](http://www.scribusstuff.org), all of which are free to use under the General Public License. There are templates for folded brochures, stationery, business newsletters, birthday cards, invitations, and more. There are also fonts available for download from the same website.

Another source for free Scribus templates available for download is [www.myshopsigns.com](http://www.myshopsigns.com). There you'll find a variety of printable sign templates similar to the ones shown in Figure 3-5 that are useful for small shops and retail outlets.



*Figure 3-5. Free shop sign templates for Scribus can be downloaded from the My Shop Signs website*

## Scribus Support

Scribus is very popular, and there is a wealth of support for it. The User Manual on the official website will take you completely through the functionality of this program. There are quite a few video tutorials on YouTube that can help get you up and running.

If you are new to desktop publishing and really want to sink your teeth into it using Scribus, I recommend studying the Design page of the Scribus website (<http://wiki.scribus.net/canvas/Category:Design>). You'll learn how to avoid design problems, as well as the basics of good design, typography, and various page layout concepts (Figure 3-6).



*Figure 3-6. Learn good design practices on the Design page of the official Scribus website*

## Serif DrawPlus Starter Edition: A Free, Basic, Vector Graphics Drawing Program

Another slimmed-down Serif product, this free download is worth looking at. Serif Draw Plus SE lacks some of the more advanced features of the full DrawPlus program (now in version X8), but it still offers a lot for those who need to create graphics quickly and easily.

**Here are a few facts about Serif Draw Plus SE at a glance:**

**Alternative to:** Adobe Illustrator

**Website:** [www.serif.com](http://www.serif.com)

**License:** Proprietary Freeware

**Operating Systems:** Windows

**Potential Savings:** \$19.99 per month (Adobe Illustrator CC subscription)

DrawPlus SE is an ideal way to explore the world of vector graphics creation. It offers enough basic features to let you create effective graphics for your business needs. I created the radio in Figure 3-7 using DrawPlus SE.



**Figure 3-7.** An illustration I created was easily rendered in Serif DrawPlus SE

## Feature Highlights

Although some of the advanced features are disabled (and the program doesn't indicate which ones are until you try to use them), there are still plenty of tools for creating graphics and illustrations:

- Pen tool for drawing Bezier curves
- Paint Brush tool
- Pencil tool
- QuickShapes

## Graphics Creation

DrawPlus SE is quite a capable program for being a free version, although advanced graphic designers will probably find it somewhat underpowered. However, despite its limitations it can still produce very good work. In addition to creating basic geometric shapes and QuickShapes, it has a Paint Brush Tool, and you can create free-hand shapes using the Pen tool (Figure 3-8).

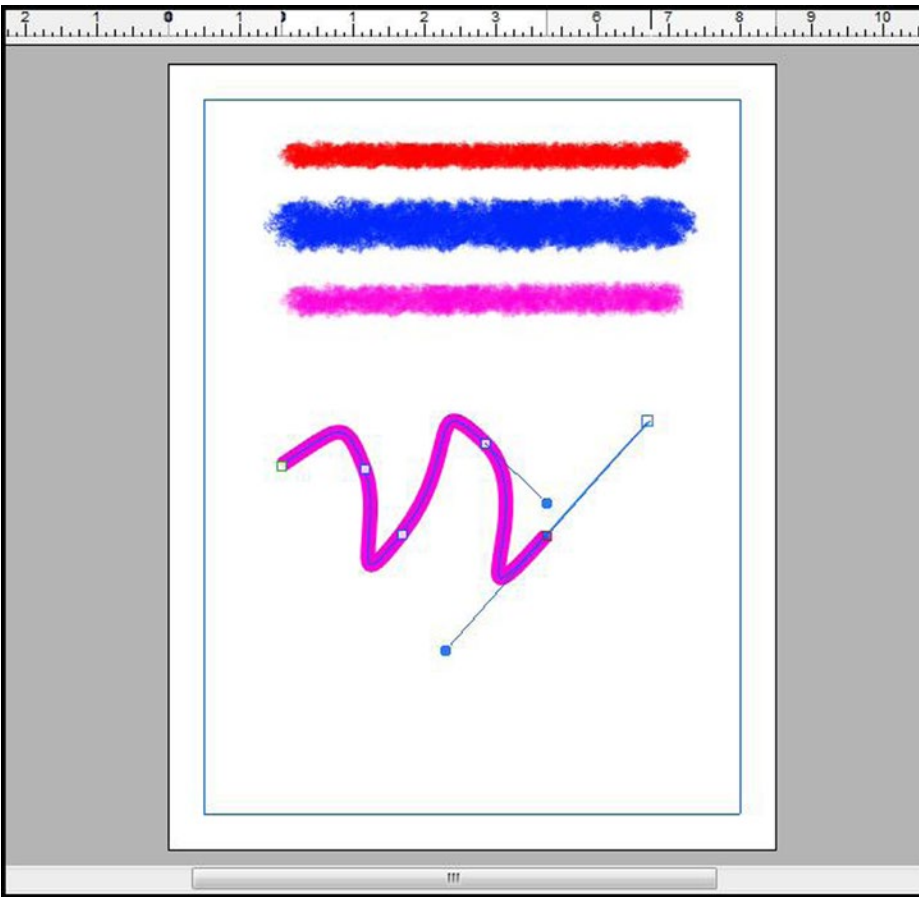

*Figure 3-8. DrawPlus SE offers a Paint Brush tool and a Pen tool*

## DrawPlus SE Support

As with PagePlus SE, you'll find a number of video tutorials on YouTube and the Serif website. The majority of the tutorials apply to the full version of DrawPlus. DrawPlus users also help one another by sharing tips and solutions on the Serif CommunityPlus forum.

## Inkscape: Pro-Quality Open Source Vector Drawing Software

Inkscape is a powerful (and popular) vector-based drawing program used for creating scalable graphics. It's used by illustrators, designers, and web designers.

**Here are a few facts about Inkscape at a glance:**

- **Alternative to:** Adobe Illustrator
- **Website:** [www.inkscape.org](http://www.inkscape.org)

- **License:** GPL
- **Current Version:** 0.91
- **Operating Systems:** Windows, Mac OS, Linux
- **Potential Savings:** \$19.99 per month (Adobe Illustrator CC subscription)

Inkscape has a wide array of tools, effects, simulated materials, and textures to create anything from simple to complex designs. Figure 3-9 shows a camera I rendered using Inkscape. The Gallery page on the Inkscape website showcases many examples of outstanding work created by digital artists using this software.

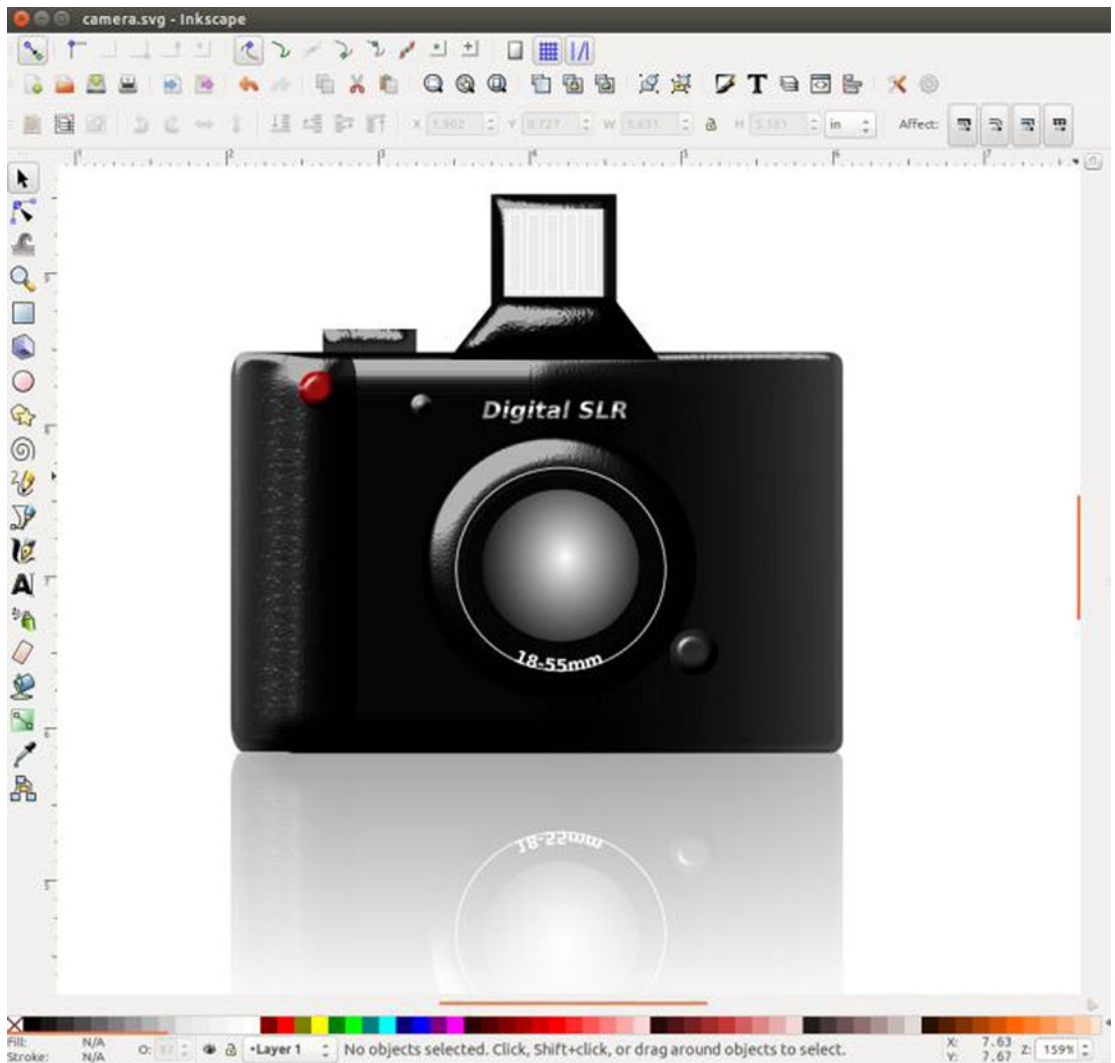

**Figure 3-9.** An illustration of a camera I created using Inkscape

## Feature Highlights

Inkscape offers many features one would expect from a full-featured illustration program such as the following:

- Flexible drawing tools
- Broad file format compatibility
- Powerful Text tool
- Bezier and Spiro curves

The detailed features are too numerous to list here (it would probably take a couple of pages of this book), but they are listed on the website. After clicking the *Features* button, you'll be prompted to click the *Explore* button similar to the example in Figure 3-10, which will take you to the list of features. One minor disadvantage of Inkscape that should be mentioned is that the floating Tools palette can't be reconfigured.



**Figure 3-10.** Click the *Explore* button on the Inkscape navigate to the *Features* page

## Graphics Creation

Inkscape offers a high degree of control over the elements (called objects in Inkscape) used to create your work. In the hands of a good designer or illustrator, Inkscape is capable of rendering very detailed and realistic drawings. In Figure 3-11, the billiard is comprised of objects such as circles and ellipses. The Fill and Stroke dialog allows you to control the type of fill (solid color, gradient, etc.). Objects can be blurred, and the degree of opacity controlled. I was able to create reasonably realistic highlights reflecting from the ball, as well as a shadow underneath.

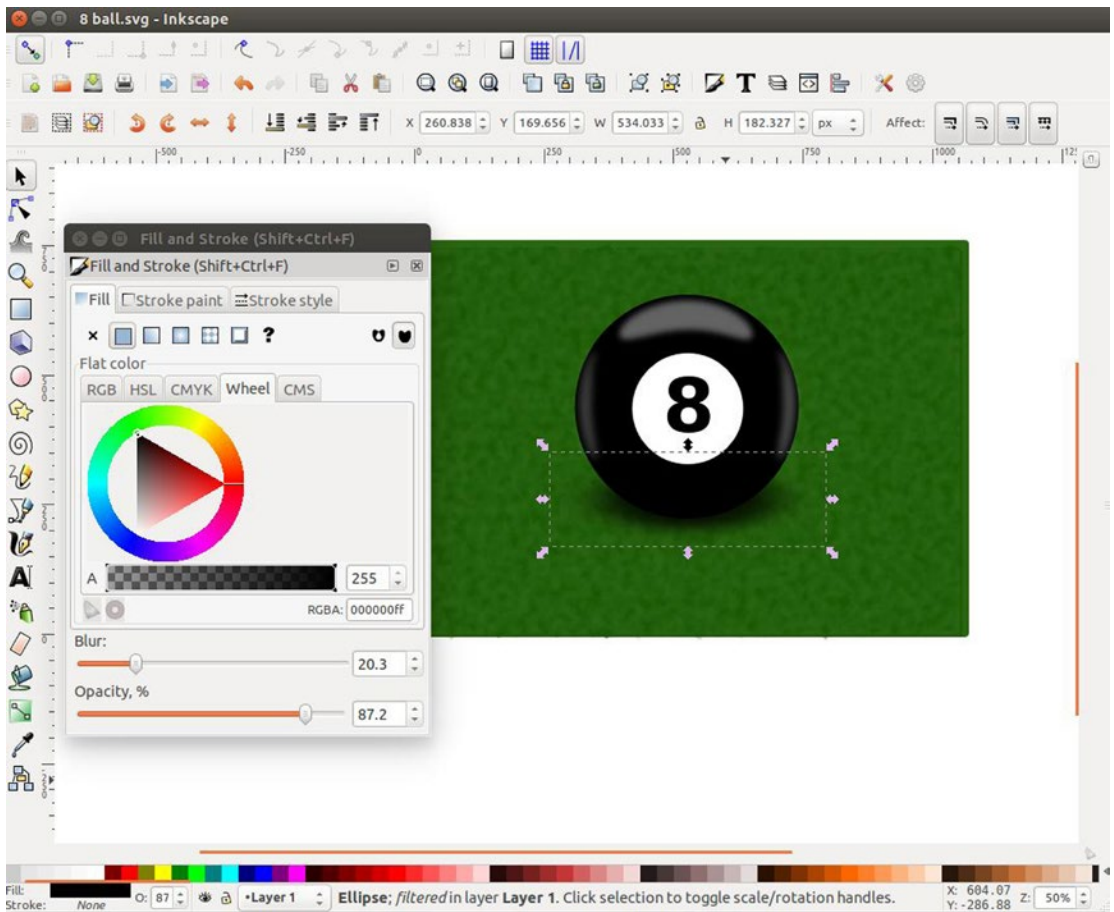

**Figure 3-11.** Objects that comprise illustrations can be edited for added realism

■ **Note** Inkscape can be demanding of your computer's resources, so the more RAM and processing power your machine has, the better.

It's possible to add realism to objects by applying various filters to them. Inkscape offers a wide variety, many of which add a 3D look. The examples in Figure 3-12 are just a few of the many available in Inkscape.

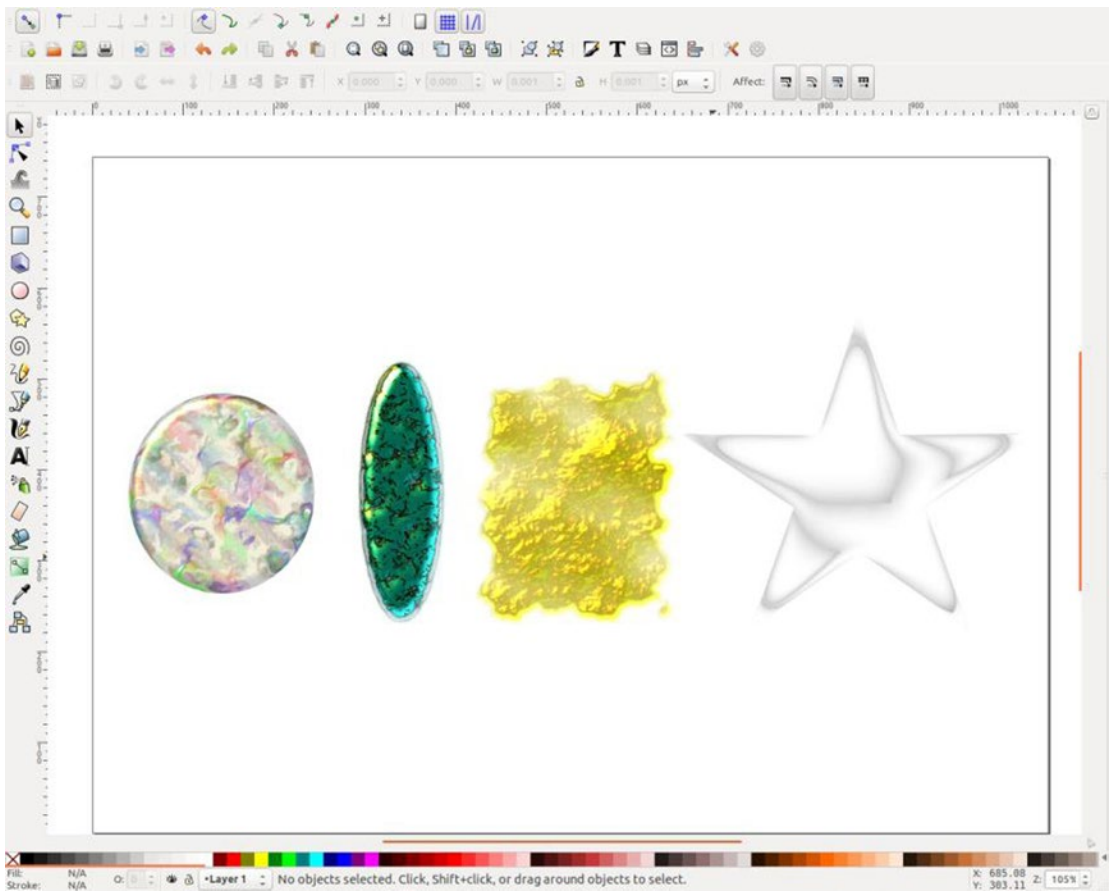

**Figure 3-12.** Applying filters to objects created in Inkscape adds a degree of realism

---

■ **Note** Inkscape’s native file format is the Inkscape SVG (*Scalable Vector Graphics*) format, but it is capable of exporting your work in a number of other file formats.

---

## Inkscape Support

Inkscape’s FAQ page on the official website is a great place to start. There are a few books available on Amazon geared towards the beginner. There are tons of video tutorials on YouTube, which can be very useful for the beginner. The vibrant Inkscape Community can also be a valuable resource for learning this powerful program. The PDF of the *Inkscape User Manual* can be downloaded from [www.valo-cd.net/guides/flossmanuals-inkscape.pdf](http://www.valo-cd.net/guides/flossmanuals-inkscape.pdf).

## Krita: The Powerful Open Source Digital Drawing and Painting Program

For those who love to draw and paint and would like to translate their skills into digital art creation, Krita is a full-featured program designed to create digital art from scratch. Take some time to look through the Gallery page on the website to see some of the incredible art that has been created by digital artists using Krita.

**Here are a few facts about Krita at a glance:**

- **Alternative to:** Corel Painter
- **Website:** <https://krita.org/>
- **License:** GPL
- **Current Version:** 2.9
- **Operating Systems:** Windows, Mac OS (experimental and unstable), Linux
- **Potential Savings:** \$429.00 (Corel Painter)

Krita is perfect for creating digital art using the wide array of tools and brushes at your disposal (Figure 3-13). For those with experience in programs like Corel Painter, Art Weaver, and other similar painting applications, the learning curve should be relatively low.

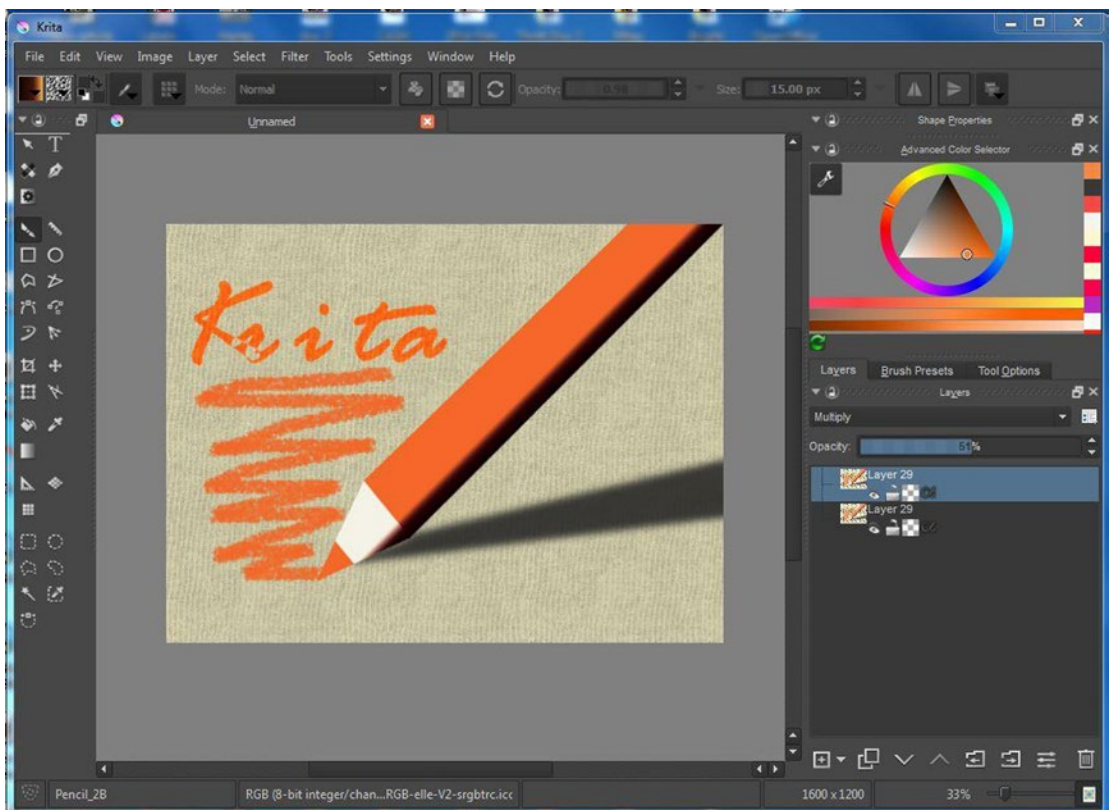

**Figure 3-13.** Krita offers a wide array of drawing and painting tools

## Feature Highlights

Krita has a long list of features that are listed in depth on the website, and I would strongly encourage anyone seriously interested in this program to read the list. Listed below are the feature highlights as they are shown on the KDE UserBase Wiki (accessed by clicking the *Krita Handbook* tab in the *Help* section of the program).

- Drawing- and painting-oriented design
- Right-click quick access to color wheel, color history, and favorite brushes
- Highly adjustable brush system
- Layers with various mixing options, including multiply, overlay, and opacity control
- Can create vector layers with complex objects and editable texts
- Supports auto-save
- Customizable toolbar, shortcuts, and drag-and-drop panels
- Wide range of document format support, including GIMP and Adobe Photoshop
- Built-in color management system, supports color space conversion, RGB, CMYK, L\*a\*b, etc.
- Extensible through OpenShiva, Python, or Ruby scripts
- Cross-platform, supports various GNU/Linux distributions, FreeBSD, Microsoft Windows, and Mac OSX

## Document Creation

When Krita is launched, you are presented with the option to open a recent document or create a custom document, and an assortment of template options, such as comic book, DSLR, film, and texture (Figure 3-14).

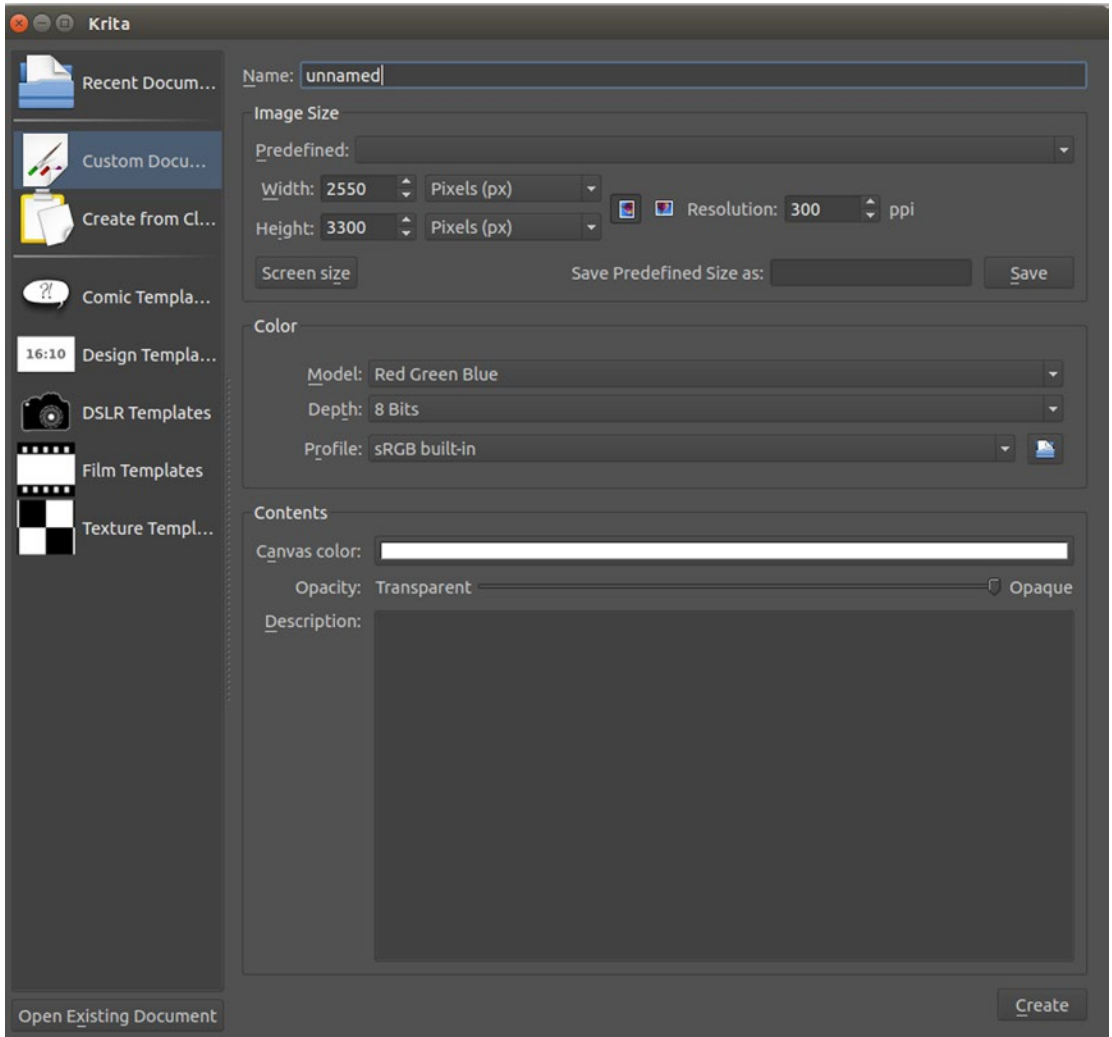

**Figure 3-14.** The new document creation window that opens upon launching Krita

## Brush Presets

There are many brush presets in Krita; airbrush, felt-tip drawing markers, pens, pencils, erasers—just about anything one would need to create stunning artwork (Figure 3-15). You can control aspects such as the brush size and opacity.



**Figure 3-15.** Krita has a wide variety of brush presets

---

■ **Tip** For those who are new to digital painting, you may want to use a graphics/drawing tablet. It gives you better control when applying brush strokes.

---

## Krita Support

There are a number of learning resources for Krita. The *Krita Handbook* is a good starting point, as is the *Learn* page on the website (Figure 3-16). You also have access to several tutorials on Krita's most used features. There are many video tutorials on YouTube as well. With this software's popularity, there's no shortage of learning material for this powerful program.

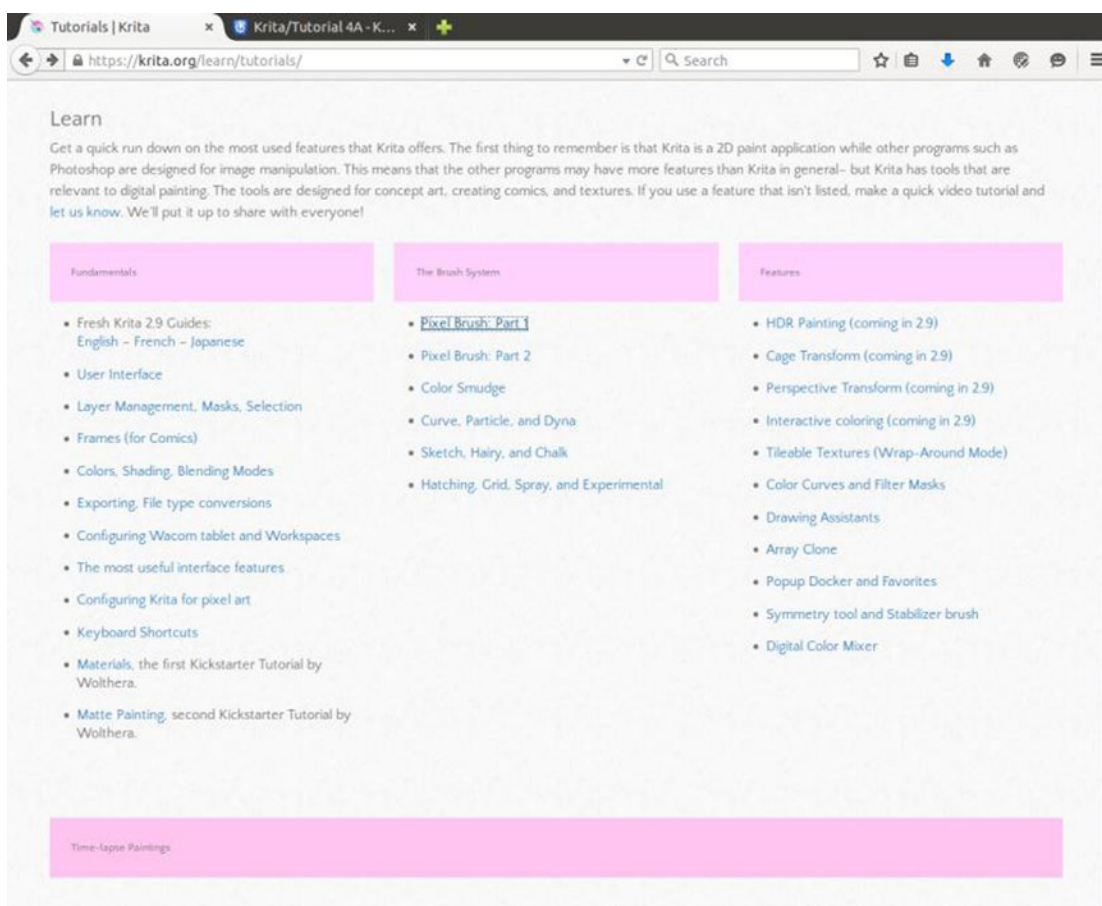

**Figure 3-16.** The Learn page on the Krita website is a good place to learn the basics

■ **Note** In addition to Krita, there are other free drawing applications worth evaluating. Appendix B covers MyPaint and Sumo Paint.

## FreeCAD: Open Source Parametric 3D Modeling Software

FreeCAD is a popular open source program for rendering 2D and 3D drawings, and it is particularly useful for mechanical design. FreeCAD has been around for a while, but is constantly evolving thanks to an active community of developers. Although it's not in the same league as the commercial counterparts (such as AutoCAD), it still offers a ton of features and is suitable for commercial use.

**Here are a few facts about FreeCAD at a glance:**

**Alternative to:** Autodesk AutoCAD

**Website:** [www.freecadweb.org](http://www.freecadweb.org)

**License:** GPL

**Current Version:** 0.15

**Operating Systems:** Windows, Mac OS, Linux

**Potential Savings:** \$140.00-160.00 per month (Autodesk AutoCAD subscription)

FreeCAD is capable of rendering 3D models for those involved in mechanical drawing, engineering, or even students studying computer-aided design. It can render everything from simple parts (Figure 3-17) to highly detailed systems.

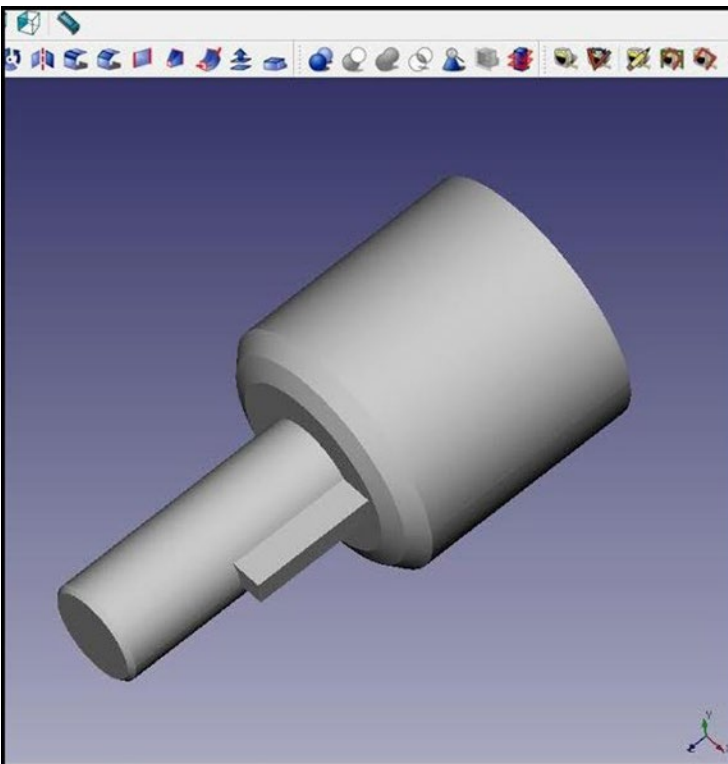

**Figure 3-17.** A machine part rendered in FreeCAD

---

■ **Note** Aspiring engineers or small start-up firms could potentially save thousands of dollars annually by using FreeCAD. Even if a firm requires a commercial application like AutoCAD on one or two computers, installing FreeCAD on the remaining computers could result in huge savings overall on licensing fees.

---

## Feature Highlights

FreeCAD has a long list of features, which can be explored in depth on the website on the *Features* list page. Here's a quick rundown of some of them:

- *A full parametric model:* Changes can be recalculated as needed while work is in progress.
- *Modular architecture:* The core application's functionality can be expanded with plug-ins.
- *Sketcher mode:* This allows sketching 2D geometry with constraint-solving capabilities.
- *A Robot module:* This allows the study of robot movements.
- *An Architecture module:* This allows a BIM (Building Information Modeling) type workflow.
- *Drawing sheets:* This allows you to put 2D views of your 3D models on a sheet.

A particularly useful feature of FreeCAD is a concept in which tools are grouped by *workbenches* (Figure 3-18). This allows only the tools needed for a specific task to be displayed. The workspace stays uncluttered and helps the program to load faster.

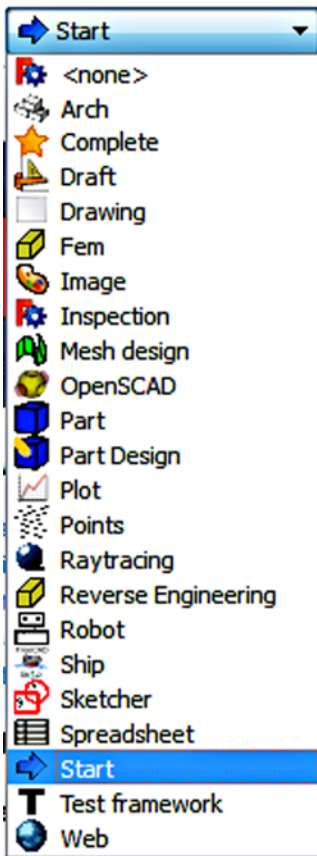

**Figure 3-18.** FreeCAD utilizes workbenches, allowing only the tools for a specific task to be displayed

## Drafting Capabilities

The Draft workbench (Figure 3-19) allows you to draw simple 2D objects, which can be modified afterwards. The Draft workbench provides a snapping system, and several utilities to manage objects and settings.

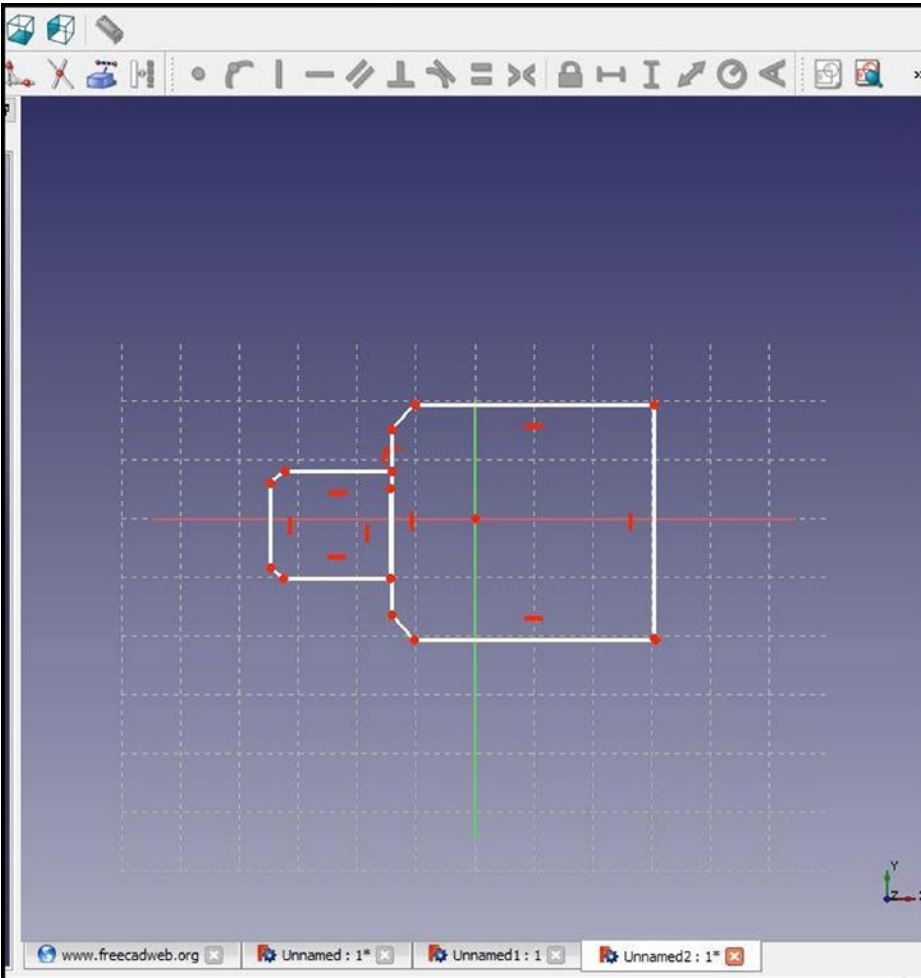

**Figure 3-19.** The Draft workbench allows the creation of simple 2D objects

## FreeCAD Support

Support for FreeCAD is a good news/bad news proposition: there is a lot of support for this program, but the majority of it isn't very beginner friendly. It might be a bit overwhelming for anyone without any mechanical drawing or engineering experience. If you have previous experience with CAD programs, the learning curve for FreeCAD should be relatively low. The website provides a great deal of information, and the Forum can be helpful for those times you get stuck.

As is the case with the other software described in this book, there are a number of YouTube tutorials that can be essential for anyone coming to grips with FreeCAD.

## Blender: The Ultimate Open Source 3D Creation Software

Blender is a free and open source professional 3D creation application. Like FreeCAD, Blender can create 3D renderings. The primary difference is that Blender is geared mainly toward animation creation for motion pictures and gaming (but it is used for other purposes).

**Here are a few facts about Blender at a glance:**

- **Alternative to:** Autodesk Maya
- **Website:** [www.blender.org](http://www.blender.org)
- **License:** GPL
- **Current Version:** 2.74
- **Operating Systems:** Windows, Mac OS, Linux
- **Potential Savings:** \$185.00 per month (Autodesk Maya subscription)

Blender is a very popular software program in the world of 3D animation. In fact, it's so powerful and feature-packed that it's hard to believe that it is a free program. It's been used to make several animated motion pictures, and it is a very robust program. It is capable of rendering water simulations, textures, and other materials with incredible realism. The screenshot from the *Features* page of the Blender website (Figure 3-20) shows two examples of work created in Blender.

---

■ **Note** There have been several animated motion pictures created using Blender. The one entitled *Big Buck Bunny* (2008) is a short animated film featuring Liam Neeson and voice-over actor Frank Welker.

---

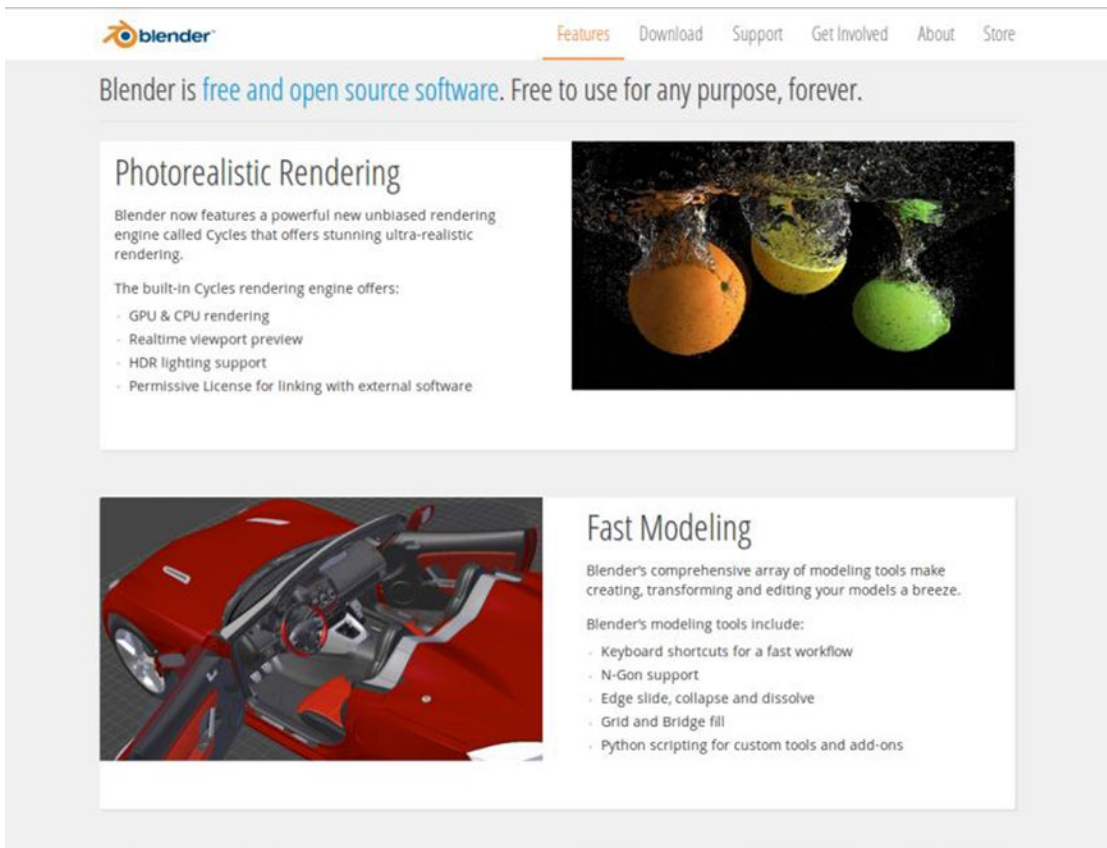

**Figure 3-20.** This screenshot shows the Blender's rendering capability

## Feature Highlights

Blender, like any high-powered software program, has a long list of features, all of which are on the Features page of the Blender website. Here's a quick look at the key features available in Blender:

- Photo-realistic rendering
- Fast modeling
- Realistic materials
- Fast rigging
- Animation toolset
- Sculpting
- Fast UV unwrapping
- Full compositor
- Amazing simulations
- Game creation

- Camera and object tracking
- Library of extensions
- Video editing
- File formats
- Flexible interface

## Rendering Capabilities

Blender is capable of very realistic and detailed 3D models. The best way to see what can be created is to spend some time on the website. Of course, everything begins somewhere. Masterpieces created using Blender start out as basic elements, which are then combined and manipulated (Figure 3-21).

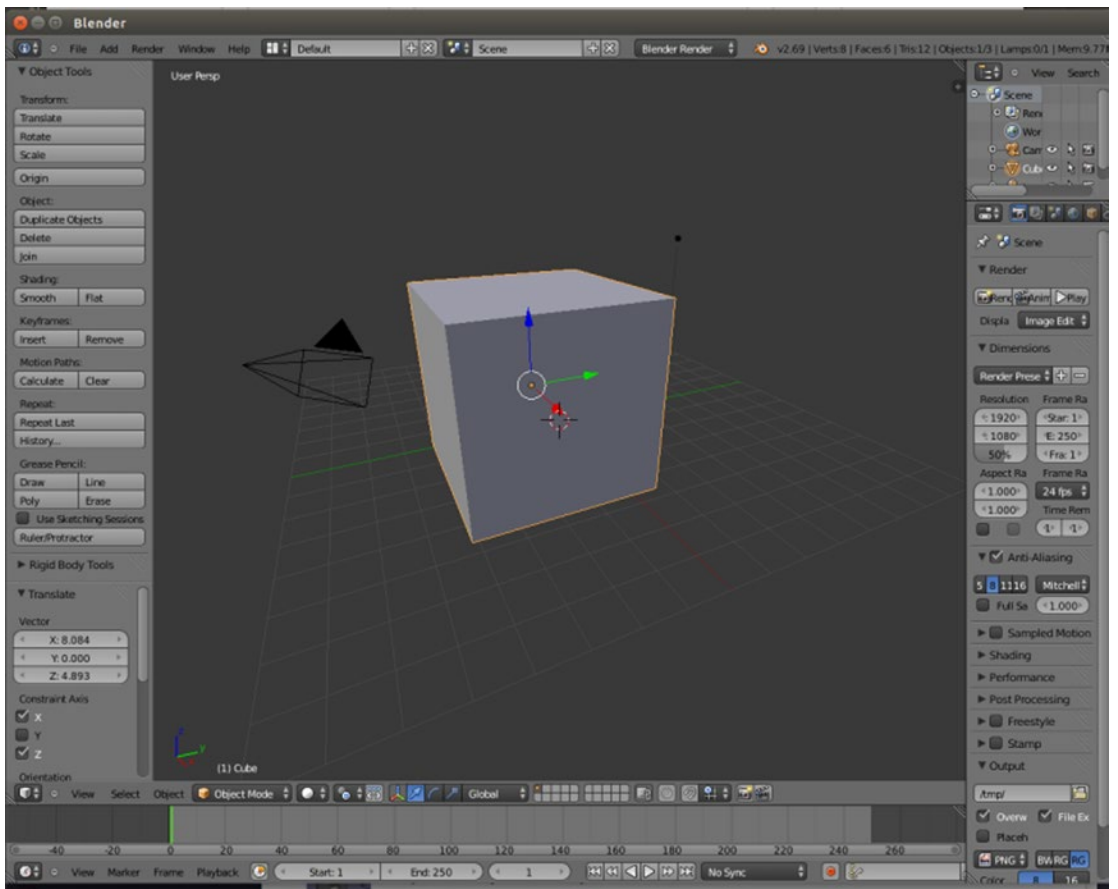

**Figure 3-21.** Blender masterpieces start out as basic elements

## Blender Support

Complex is probably a gross understatement to sum up Blender. If you're a beginner, you'll likely be overwhelmed by all of the bells and whistles. Fortunately, there is ample support and documentation on the website to start the learning process (Figure 3-22). It has an online manual, tutorials, and even professional-level support. YouTube also has quite a few tutorial videos aimed at beginners.

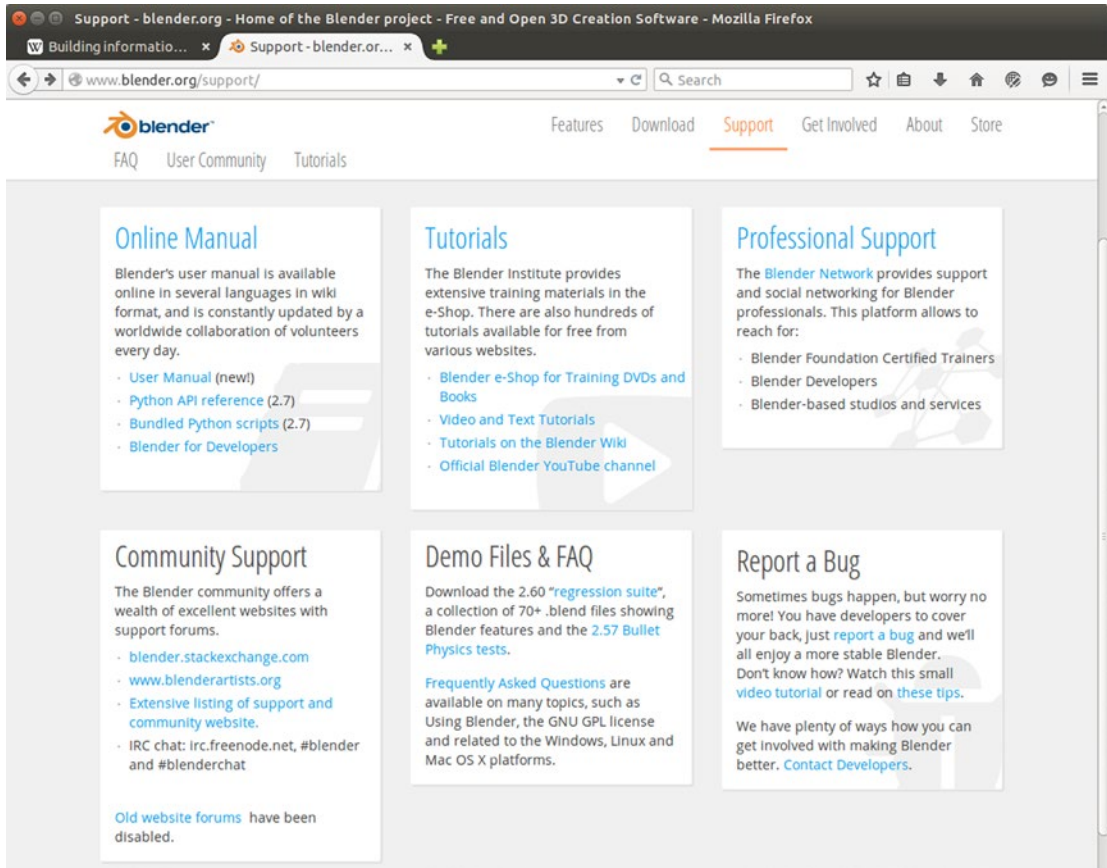

**Figure 3-22.** Lots of support can be found on the official Blender website

## Summary

In this chapter, you looked at some useful free and free open source solutions for desktop publishing. Serif PagePlus Starter Edition is an easy-to-use program that offers themed layouts, as well as the ability to create documents from scratch. Scribus is a powerful, open source desktop publishing program capable of producing impressive documents ranging from brochures and flyers to magazines. Scribus is used by enthusiasts and professionals the world over.

You examined two illustration programs: Serif DrawPlus Starter Edition and Inkscape. DrawPlus SE offers helpful features such as QuickShapes to help make illustration fast and easy for non-designers.

Inkscape is a professional-quality, open source program with tons of features. Inkscape is capable of producing stunning graphics.

Krita is a powerful, open source drawing and painting program capable of producing digital artwork by simulating traditional media. Two more drawing programs not in this chapter but touched on in Appendix B are MyPaint and Sumo Paint.

FreeCAD and Blender are two complex and powerful open source programs design for 3D model creation. FreeCAD is used primarily for mechanical drawing, architecture, and engineering. Blender is mainly used for creating 3D animations for motion pictures and game creation, although it can be used for other purposes.

The next chapter will look at several no-cost photo editing programs. The programs range from easy-to-use, entry level programs to advanced, professional-level programs.

## CHAPTER 4



# Photo Editing Software

When you think of photo editing, Adobe Photoshop probably springs to mind. It is the industry standard and the ultimate in photo editing software. There are many professionals who use Adobe products because they are involved with very high-end print production, photography, or just locked into an Adobe work flow. However, for many small business owners, freelance photographers, and designers, Photoshop is either too expensive (even at \$19.99 per month for the subscription service), people don't like the idea of "renting" software, or it's just overkill.

Since digital photography has become mainstream, the ability to work with digital images is an important aspect for most businesses. Fortunately, there are many no-cost photo editing programs to help you get best out of your digital photos. This chapter looks at several photo editing programs, ranging from simple (applying effects automatically) to professional level (with a wide range of editing capabilities).

Here's a quick look at the programs we'll cover in this chapter:

- **PhotoScape:** An entry-level photo editing tool that offers minor, easy photo corrections and a wealth of special effects filters
- **Paint.NET:** A lightweight yet powerful photo editor for Windows with graphics creation capability
- **GIMP:** A professional photo editing and graphics creation program almost in the same league as Adobe Photoshop
- **Autodesk Pixlr:** A family of cloud-based and mobile applications for photo editing and adding special effects
- **UFRaw:** A program for processing RAW images (RAW is the uncompressed format used by many higher-end cameras)
- **FotoSketcher:** A program that automatically creates art from photographic images

---

■ **Note** Two helpful websites worth checking out are [www.opensourcephotography.org](http://www.opensourcephotography.org) and [www.opensourcealternative.org](http://www.opensourcealternative.org).

---

---

**Electronic supplementary material** The online version of this chapter (doi:10.1007/978-1-4842-1130-4\_4) contains supplementary material, which is available to authorized users.

## PhotoScape: An Easy-to-Use Photo Editor for Beginners

If you use Windows or Mac OS and require a program to perform basic photo editing functions such as cropping, red-eye removal, adjusting contrast, etc., then PhotoScape is really worth trying out, particularly for those with little or no previous photo editing experience.

**Here are a few facts about PhotoScape at a glance:**

- **Alternative to:** Adobe Photoshop, Photoshop Elements
- **Website:** [www.photoscape.org](http://www.photoscape.org)
- **License:** Proprietary Freeware
- **Current Version:** 3.7
- **Operating Systems:** Windows, Mac OS
- **Potential Savings:** \$19.99 per month (Photoshop subscription)

Upon launching the program, you'll be greeted with a menu that makes it easy to navigate to the desired function (Figure 4-1).

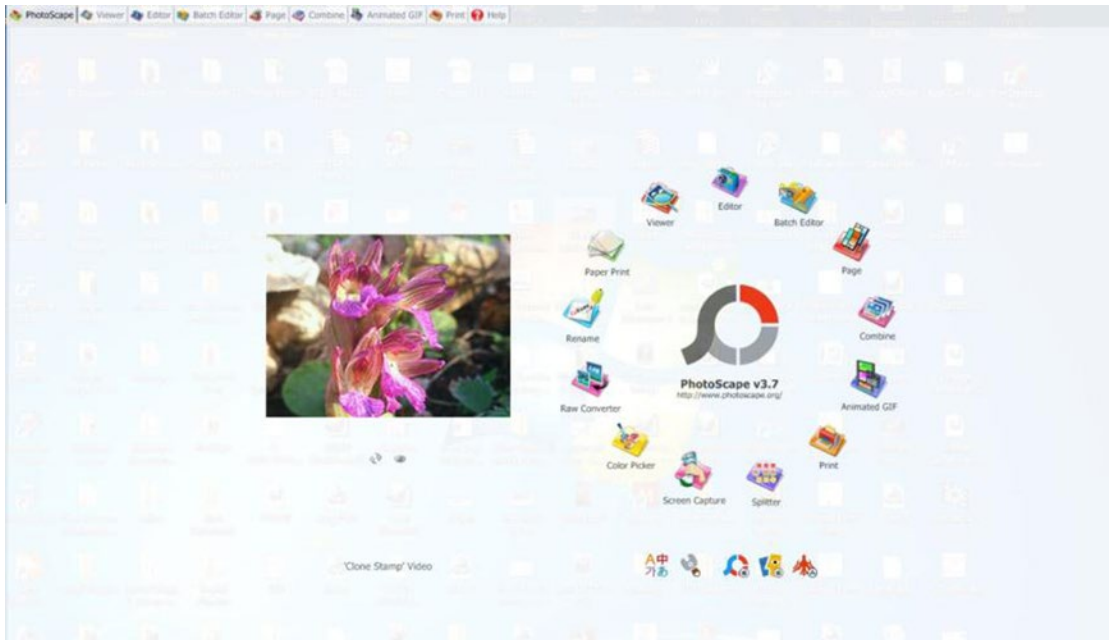

**Figure 4-1.** PhotoScape makes it easy to navigate to the desired function upon launching. (Used with permission © Mooitech 2015)

## Feature Highlights

Even though PhotoScape could be considered an entry-level editing application (it only has a few editing tools compared to other programs), it does offer many useful functions.

Here are PhotoScape's features as listed on the software provider's website:

- *Viewer*: View photos in your folder, create a slideshow
- *Editor*: Resizing, brightness and color adjustment, white balance, backlight correction, frames, balloons, mosaic mode, adding text, drawing pictures, cropping, filters, red eye removal, blooming, paint brush, clone stamp, effect brush
- *Batch editor*: Batch edit multiple photos
- *Page*: Merge multiple photos on the page frame to create one final photo
- *Combine*: Attach multiple photos vertically or horizontally to create one final photo
- *Animated GIF*: Use multiple photos to create a final animated photo
- *Print*: Print portrait shots, carte de visites (CDV), passport photos
- *Splitter*: Slice a photo into several pieces
- *Screen Capture*: Capture your screenshot and save it
- *Color Picker*: Zoom in on images, search and pick a color
- *Rename*: Change photo file names in batch mode
- *Raw Converter*: Convert RAW to JPG
- *Paper Print*: Print lined, graph, music, and calendar paper
- *Face Search*: Find similar faces on the Internet

## Tools

PhotoScape has a basic toolset for performing minor retouching tasks and applying effects. One of the more useful tools is the *Clone Stamp* tool. It is used for removing defects and unwanted objects, or for duplicating certain parts of the image. I used it to remove the plastic pail behind the dog (Figure 4-2).



**Figure 4-2.** Using the Clone Stamp tool to remove the plastic pail behind the dog (Used with permission © Mooiitech 2015)

The *Effect Brush* is another useful tool. It can lighten or darken portions of an image (much like the dodge and burn tools in Photoshop), soften and blur areas of an image, and apply a few fun effects as well. The other tools are the *Paint Brush*, *Color Picker*, *Mosaic*, *Mole Removal*, and *Screen Scroll*.

---

■ **Note** If you are reading the print edition of this book and would like to see the color versions of these figures, the PDF color plates can be downloaded from the book’s source code section on the Apress website.

---

## Filters

While PhotoScape just has a basic toolset, it has a rich assortment of *filters*, which are functions that modify the appearance of an image. There are many effects that can be created using PhotoScape’s filters. There are filters that can modify images to look like paintings or drawings, or you can apply various tones, just to name a few. Filters can give images a certain look and feel. To give the image of the cowboy a look more consistent with the Old West, I first applied a sepia tone and then one of the *Vintage Effect* filters (Figure 4-3).

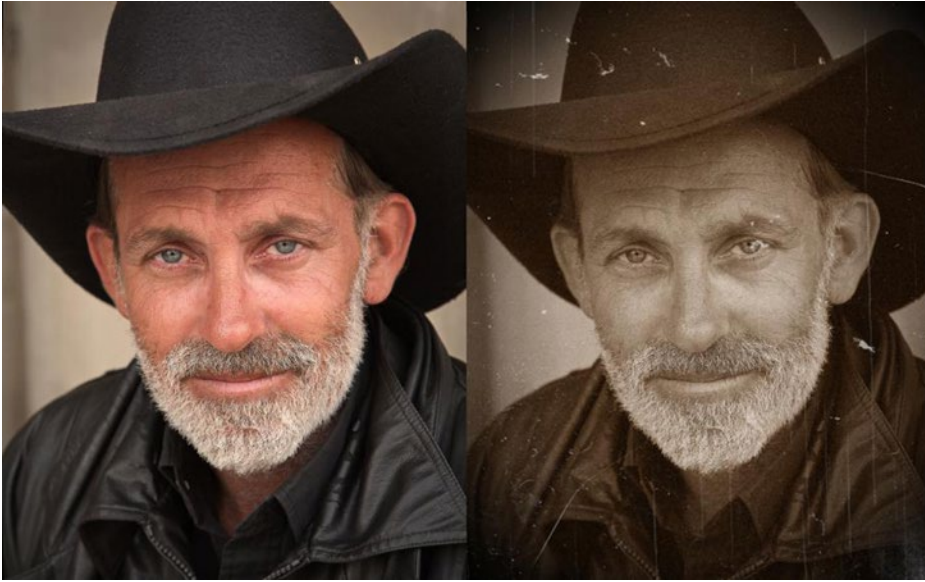

**Figure 4-3.** *Before and after comparison*

## Objects

PhotoScape lets you have fun with your images by allowing you to add *Objects* to your images. The Objects in the Office category (Figure 4-4) are useful for enhancing images that will be used in business communications, such as newsletters or marketing pieces. The Christmas-themed Objects come in handy when making Christmas cards, holiday-themed images, etc.

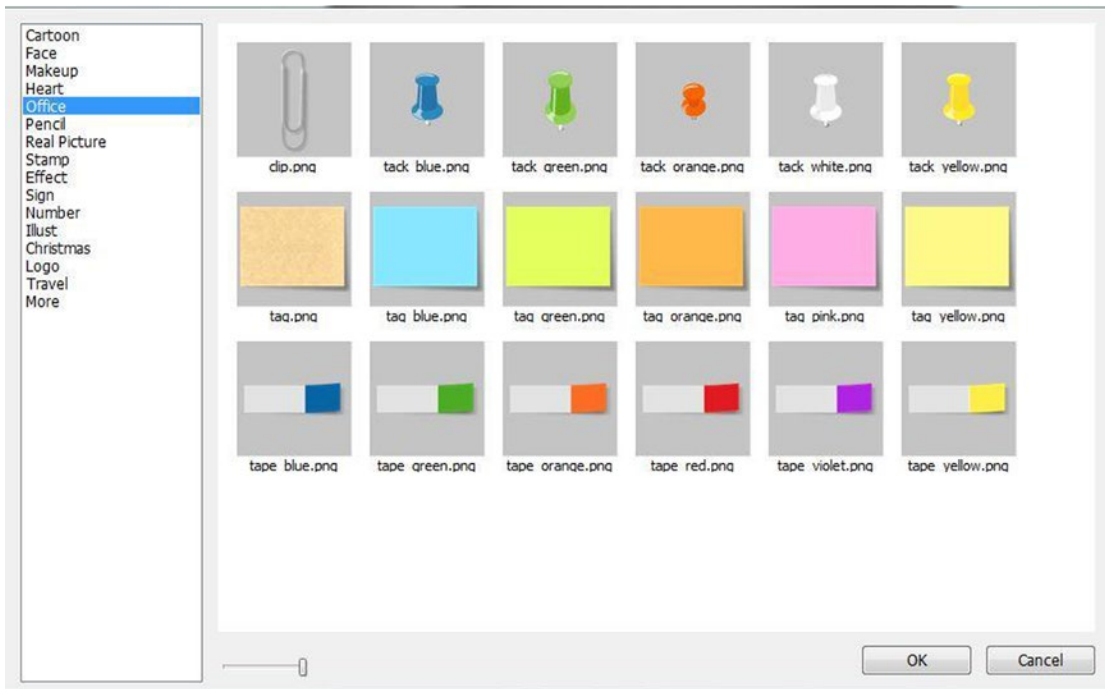

**Figure 4-4.** Have fun with your images using PhotoScape Objects. (Used with permission © Mooitech 2015)

## PhotoScape Support

A great starting point for learning PhotoScape is the documentation on the *Help* page of the website. The *Intro video* gives a quick tour of the functions of PhotoScape (Figure 4-5). You can access even more helpful videos under the software's *Help* tab. There are also a number of PhotoScape tutorials on YouTube.

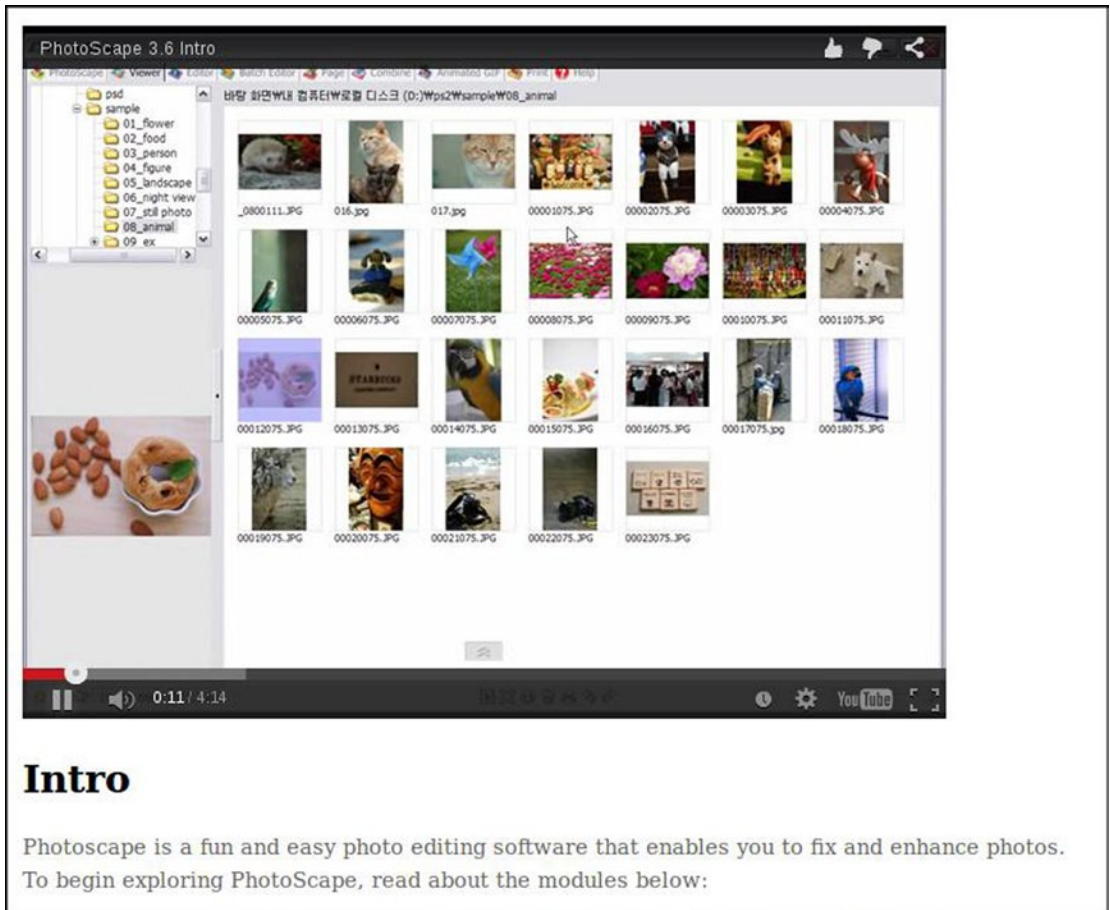

*Figure 4-5. The Intro video on the Help page of PhotoScape's website (Used with permission © Mooiitech 2015)*

## Paint.NET: Basic Image Editing for Windows

Paint.NET is a popular, no-cost editing program for Windows. Although still easy enough for beginners to jump into and master with a little practice, it's a step up from PhotoScape. Anyone with experience using commercial image editing software will have a very low learning curve using this program and will pick it up in no time.

**Here are a few facts about Paint.NET at a glance:**

- **Alternative to:** Adobe Photoshop, Photoshop Elements
- **Website:** [www.getpaint.net](http://www.getpaint.net)
- **License:** Proprietary Freeware
- **Current Version:** 4.0.5
- **Operating Systems:** Windows
- **Potential Savings:** \$19.99 per month (Photoshop subscription)

Paint.NET has an interface that is somewhat reminiscent of Photoshop, but its unique focus is on being intuitive and easy to learn (Figure 4-6). Many of the functions use keyboard shortcuts that will make work faster and more efficient.

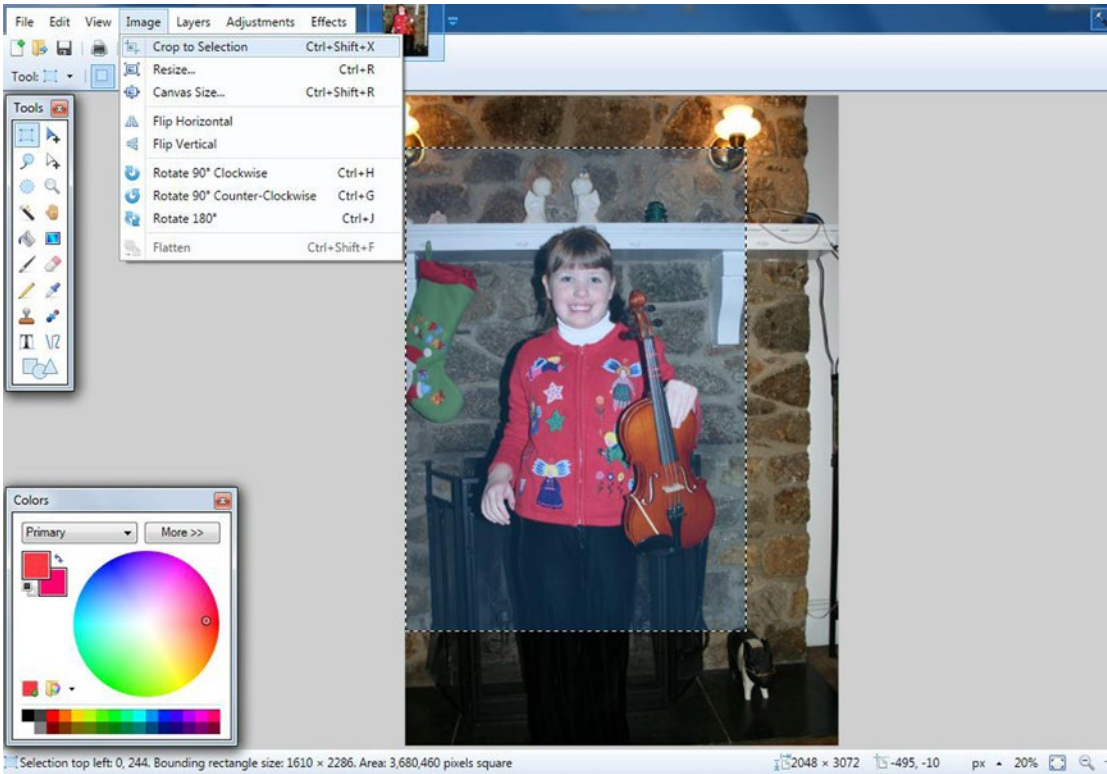

**Figure 4-6.** The Paint.NET interface is designed to be intuitive and easy to learn. (Used with permission © Rick Brewster 2015)

## Feature Highlights

Paint.NET offers an impressive array of features and functionality for a free program. The website states that “It is one of the fastest free photo editors for Windows, with a capable feature set that stops just short of some of the professional manipulation tools.”

These are the features as described on the software provider's website:

- **Simple, intuitive, and innovative user interface:** Every feature and user interface element was designed to be immediately intuitive and quickly learnable without assistance. In order to handle multiple images easily, Paint.NET uses a tabbed document interface. The tabs display a live thumbnail of the image instead of a text description. This makes navigation very simple and fast. The interface is also enhanced for Aero Glass if you are using Windows 7 or Vista.
- **Performance:** Extensive work has gone into making Paint.NET the fastest image editor available. Whether you have a netbook with a power-conscious Atom CPU or a Dual Intel Xeon workstation with eight blazingly fast processing cores, you can expect Paint.NET to start up quickly and be responsive to every mouse click.
- **Layers:** Usually only found on expensive or complicated professional software, layers form the basis for a rich image composition experience. You may think of them as a stack of transparency slides that, when viewed together at the same time, form one image.
- **Active online community:** Paint.NET has an online forum with a friendly, passionate, and ever-expanding community. Be sure to check out the constantly growing list of tutorials and plug-ins.
- **Automatically updated:** Updates are free, and they contain new features, performance improvements, and bug fixes. Upgrading to the latest version is very simple, requiring only two clicks of the mouse.
- **Special effects:** Many special effects are included for enhancing and perfecting your images. Everything from blurring, sharpening, red-eye removal, distortion, noise, and embossing are included. Also included is a unique 3D Rotate/Zoom effect that makes it very easy to add perspective and tilting. Adjustments are also included, which help you tweak an image's brightness, contrast, hue, saturation, curves, and levels. You can also convert an image to black-and-white or sepia-toned.
- **Powerful tools:** Paint.NET includes simple tools for drawing shapes, including an easy-to-use *Curve* tool for drawing splines or Bezier curves. The *Gradient* tool, new for 3.0, has been cited as an innovative improvement over similar tools provided by other software. The facilities for creating and working with selections are powerful, yet still simple enough to be picked up quickly. Other powerful tools include the *Magic Wand* for selecting regions of similar color, and the *Clone Stamp* for copying or erasing portions of an image. There is also a simple text editor, a tool for zooming, and a *Recolor* tool.
- **Unlimited History:** Everybody makes mistakes, and everybody changes their mind. To accommodate this, *every* action you perform on an image is recorded in the History window and may be undone. Once you've undone an action, you can also redo it. The length of the history is only limited by available disk space.
- **Free:** Paint.NET doesn't cost a dime!

## Editing Capabilities

Paint.NET can handle a number of editing tasks ranging from simple to fairly complex. It's great for touching up images, making composite images, and correcting color and exposure, to name a few. It offers several tools for correcting exposure and color, but the most advanced is the *Curves* dialog, which is used to correct tonal quality and color with precision (Figure 4-7). Curves is a high-end tool usually found only in more complex image editors.

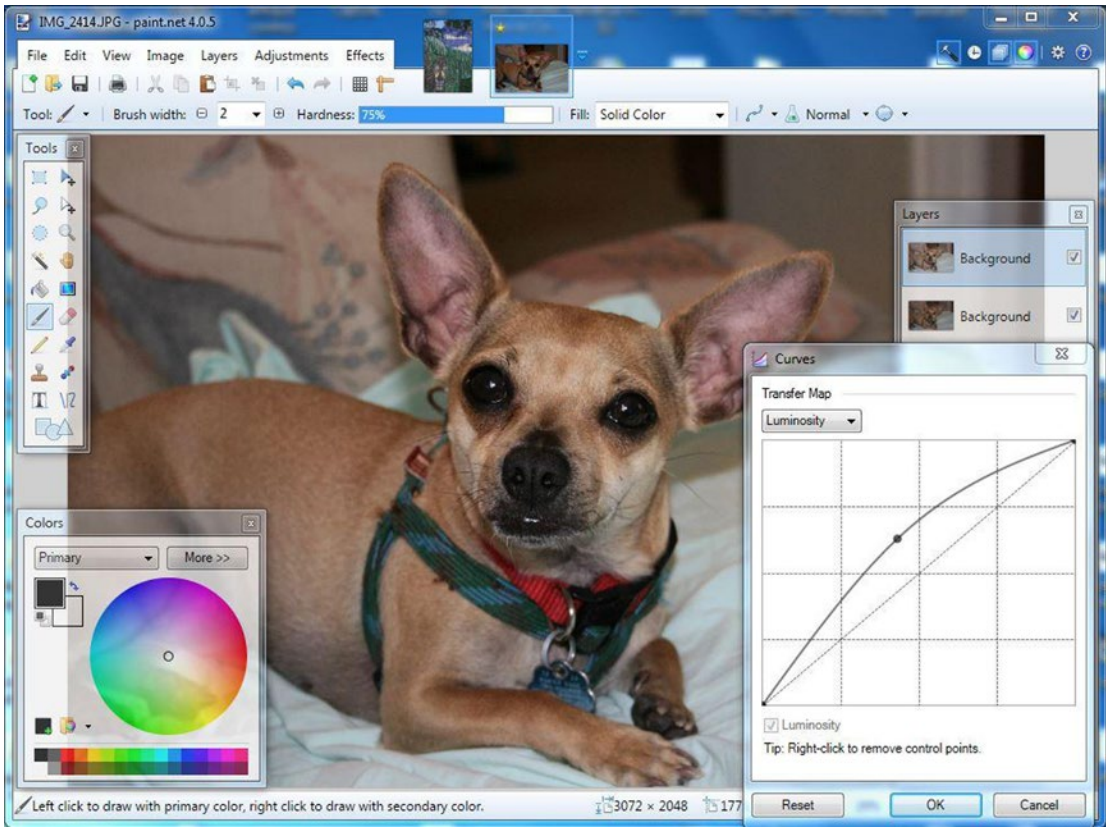

**Figure 4-7.** Correcting exposure using Curves (Used with permission © Rick Brewster 2015)

Paint.NET has a decent assortment of editing tools (although it lacks a few, such as the Dodge and Burn tools). Among them is a *Clone Stamp* tool that is essential in many image editing tasks. Figure 4-8 demonstrates its usefulness by digitally removing the date stamp from the upper right portion of the image.



**Figure 4-8.** Removing the date stamp using the Clone Stamp tool(Used with permission © Rick Brewster 2015)

Paint.NET employs the use of *layers*, which allows for the placement of graphical elements without directly affecting the original image. The layers in Paint.NET have several *blending modes* to choose from. Blending modes determine how the layer's pixels interact with those of the image below. Additionally, the opacity/transparency of each layer can be controlled. This allows the use of advanced editing techniques, such as adding color to a monochrome image (Figure 4-9).

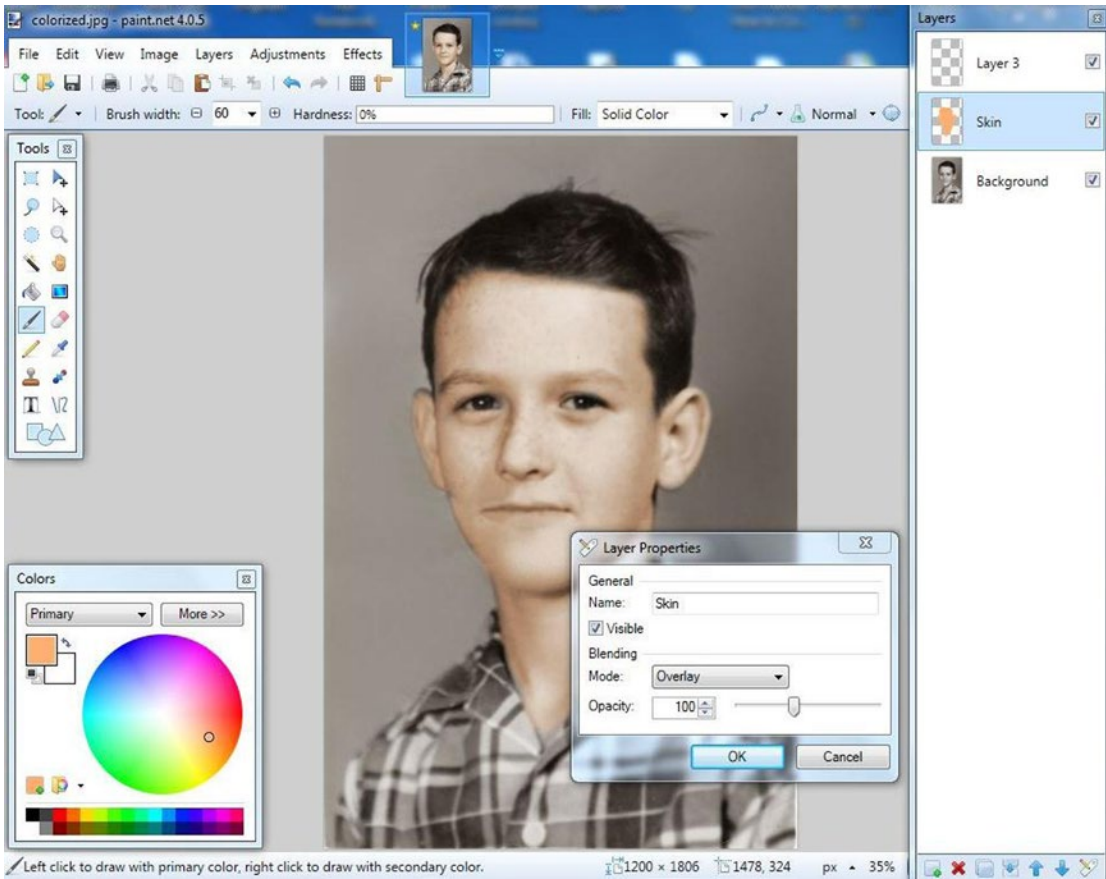

**Figure 4-9.** Using layers to add a hand-tinted look to a monochrome image (Used with permission © Rick Brewster 2015)

By using a dedicated layer for each element colorized, there is a greater degree of editing control. The end result is a monochrome image with a reasonably natural, hand-tinted look added (Figure 4-10).



**Figure 4-10.** *Before and after comparison*

---

■ **Note** There are quite a few useful plug-ins that are available to extend Paint.NET's capabilities. Plug-ins are software add-ons written by the Paint.NET community, and information about them is available on the Forum section of the software provider's website.

---

## Graphics Creation

In addition to editing digital photos, Paint.NET is capable of creating useful graphics from the ground up. While it's not in the league of more full-featured programs, it's still powerful enough to render eye-catching art (Figure 4-11). There are several predesigned drawing shapes (arrows, polygons, etc.) that will aid in creating graphics.

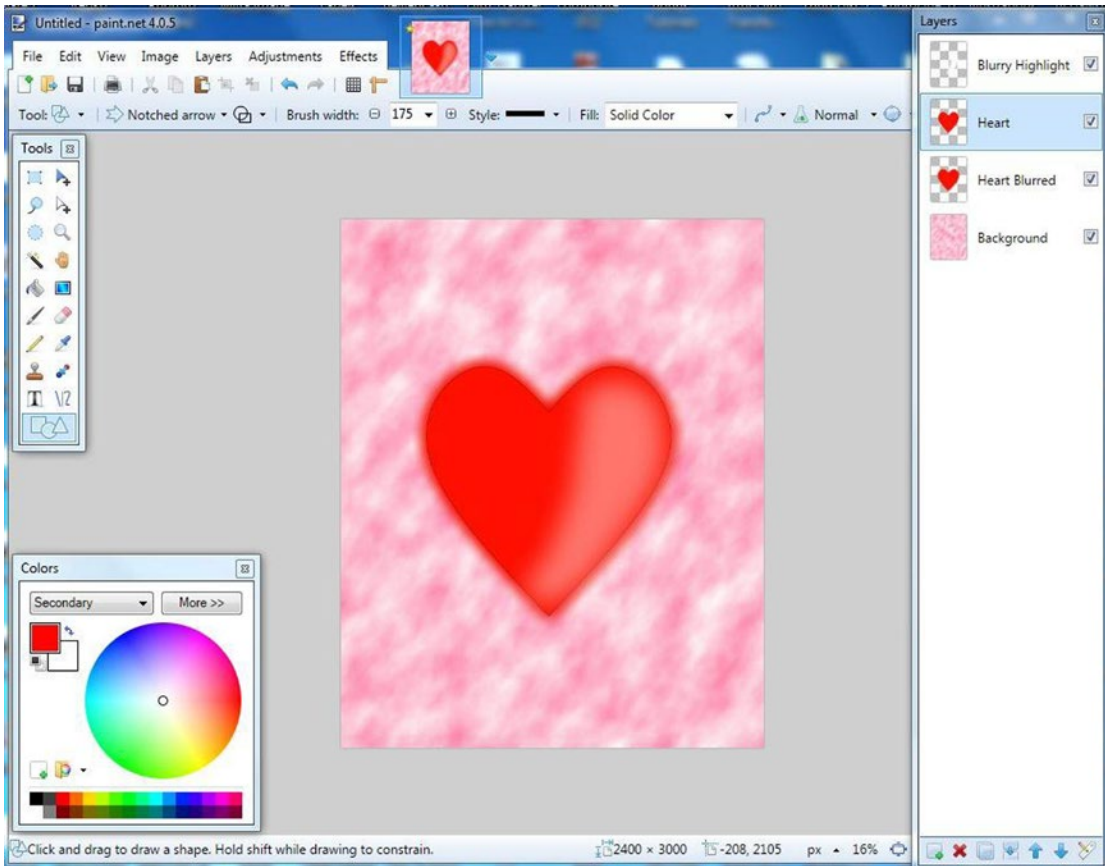

**Figure 4-11.** Paint.NET is capable of creating original graphics. (Used with permission © Rick Brewster 2015)

## Paint.NET Support

Paint.NET's ease of use makes it a popular program, and based on what I've read while perusing the forums, users of this program seem quite passionate about it. There is a great deal of information in the *Forums* section, including a *Discussions and Questions* page. YouTube also has a number of tutorials aimed at the beginner. You can probably learn everything you want to about this program from the information available on the Web. For those who want to dig even deeper, there are several books about Paint.NET available on Amazon.

## GIMP: The Premier Open Source Image Editor

GIMP (which stands for GNU Image Manipulation Program) is arguably the most powerful, full-featured, no-cost image editing program. Currently in version 2.8, it has been around since the mid-1990s. It's very popular and enjoys a huge amount of support from the open source community. It's still not in the same strata as Adobe Photoshop, but it comes close enough for many users.

**Here are a few facts about GIMP at a glance:**

- **Alternative to:** Adobe Photoshop, Photoshop Elements
- **Website:** [www.gimp.org](http://www.gimp.org)

- **License:** GPL
- **Current Version:** 2.8
- **Operating Systems:** Windows, Mac OS, Linux, and Unix derivatives
- **Potential Savings:** \$19.99 per month (Photoshop subscription)

GIMP is an extremely capable image editor loaded with many high-end features normally only seen in expensive commercial editors. It's used by enthusiasts and professionals worldwide. Figure 4-12 shows the GIMP interface on Windows 7.

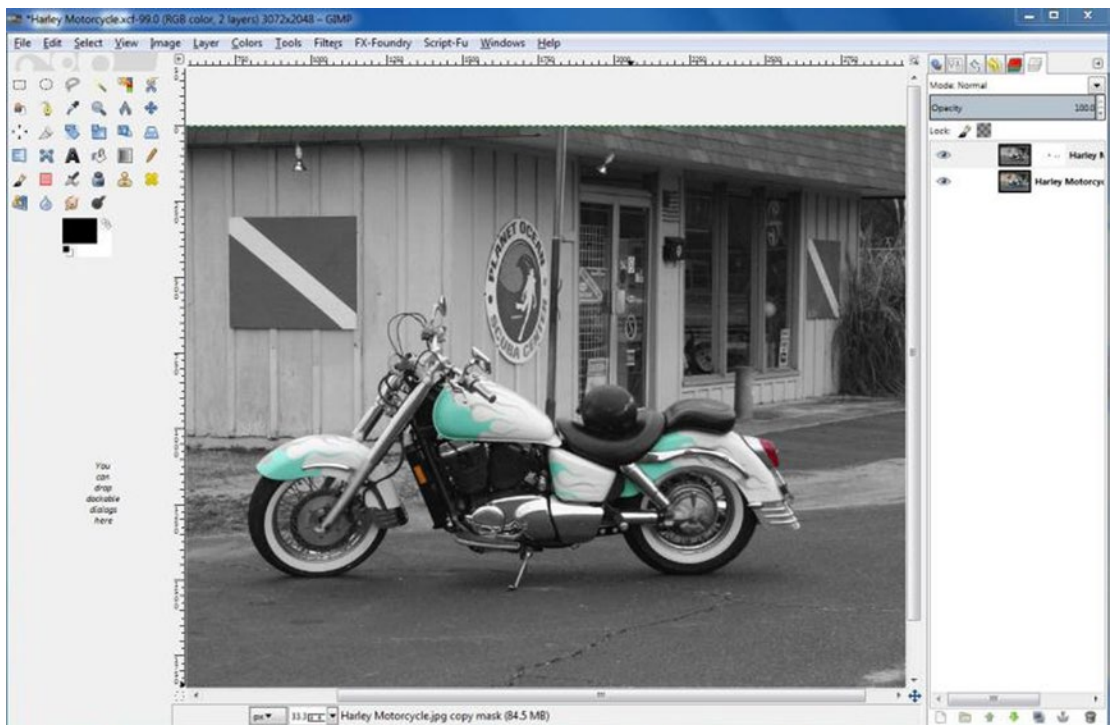

**Figure 4-12.** The GIMP interface on Windows 7

## Feature Highlights

GIMP offers a dazzling array of high-end features. Being the powerful program that it is, it isn't as user friendly to the beginner as PhotoScape or Paint.NET. However, if you are willing to invest the time it takes to gain proficiency, it will handle just about any image editing task. Here are the features as described on the official GIMP website:

- **Customizable Interface:** Each task requires a different environment, and GIMP allows you to customize the view and behavior the way you like it. The widget theme allows you to change colors, widget spacings, and icon sizes, and there are custom tool sets in the toolbox. The interface is modularized into so-called docks, allowing you to stack them into tabs or keep them open in their own window. Pressing the *Tab* key will toggle them hidden. GIMP features a great *fullscreen mode* that allows you to not only preview your artwork but also to do editing work while using the most of your screen estate.
- **Photo Enhancement:** Numerous digital photo imperfections can be easily compensated for via GIMP. Fix *perspective distortion* caused by lens tilt simply by choosing the *corrective mode* in the transform tools. Eliminate lens *barrel distortion* and *vignetting* with a powerful filter but a simple interface. The included *channel mixer* gives you the flexibility and power to get your B/W photography to stand out the way you need.
- **Digital Retouching:** GIMP is ideal for advanced photo retouching techniques. Get rid of unneeded details using the *Clone* tool, or touch up minor details easily with the new *Healing* tool. With the *Perspective Clone* tool, it's not difficult to clone objects with perspective in mind just as easily as with the *Orthogonal* clone.
- **Hardware Support:** GIMP includes very unique support for various input devices out of the box, including pressure and tilt sensitive tablets, and a wide range of USB or MIDI controllers. You can bind often-used actions to device events such as rotating a USB wheel or moving a MIDI controller's slider. Change the size, angle, or opacity of a brush while you paint, or bind your favorite scripts to buttons. Speed up your workflow!
- **File Formats:** The file format support ranges from the common likes of JPEG (JFIF), GIF, PNG, and TIFF to special-use formats such as the multi-resolution and multi-color-depth Windows icon files. The architecture allows you to extend GIMP's format capabilities with a plug-in. You can find some rare format support in the GIMP plug-in registry. Thanks to the transparent virtual file system, it is possible to load and save files to from remote locations using protocols such as FTP, HTTP, or even SMB (MS Windows shares) and SFTP/SSH. To save disk space, any format can be saved with an archive extension such as ZIP, GZ, or BZ2, and GIMP will transparently compress the file without you needing to do any extra steps.

---

■ **Tip** There are many plug-ins available for GIMP to expand its capability. Just check out the Plug-in Registry page of the official GIMP website for a look at what's available.

---

## Editing Capabilities

GIMP can handle just about any kind of image editing task, from minor retouching to major image editing. GIMP has an extensive toolset, including the ones you'd expect to find, such as the *Clone Stamp* tool. It also includes a *Healing* tool, which is very helpful for touching up blemishes, lines, creases, and other flaws in portraits (Figure 4-13). GIMP can support the CMYK color model (the Separate + plug-in must be installed, however).

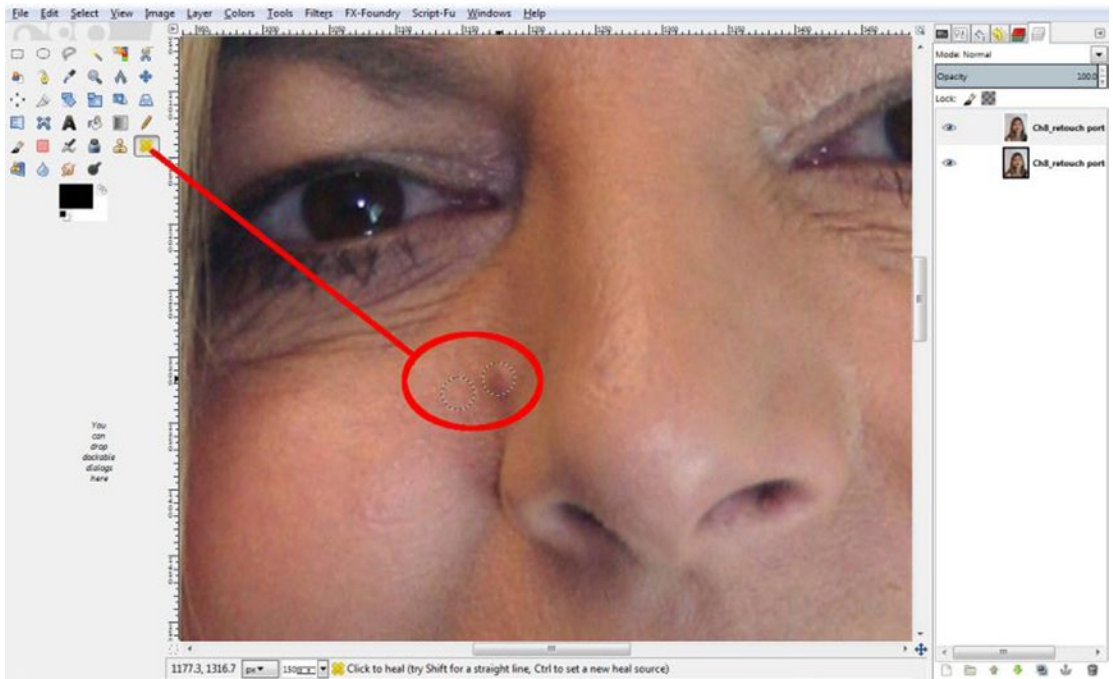

**Figure 4-13.** The Healing tool is useful for removing blemishes and other imperfections in portraits

The *Perspective* tool is a handy for correcting images with lens distortion, or correcting the perspective of buildings or other structures (Figure 4-14).

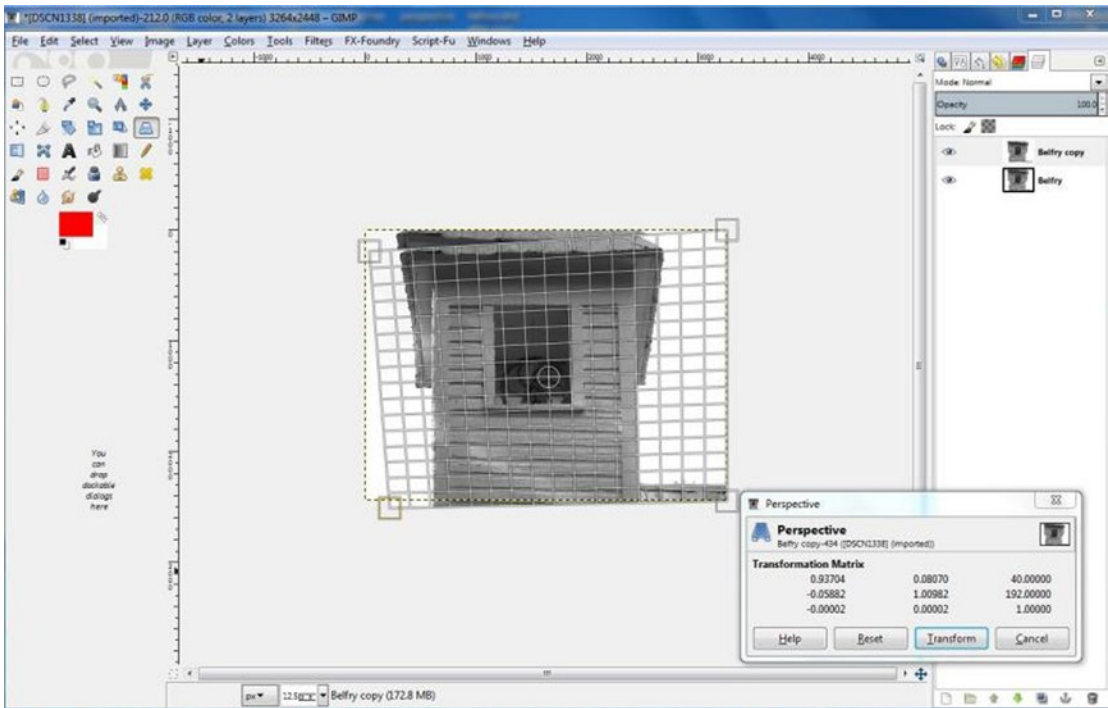

**Figure 4-14.** The Perspective tool is useful for correcting images with lens distortions or perspective problems

The image of the belfry was shot from the ground, creating a slanted look. Using the *Perspective* tool in GIMP corrects the problem, resulting in a much better looking image (Figure 4-15).



**Figure 4-15.** The Perspective tool corrects the slanted look of the image

## Graphics Creation

GIMP is a very capable tool for creating graphics from the ground up. It hosts a wide assortment of brush styles, effects, and other functions to create impressive designs. Figure 4-16 is an example of a design I created entirely in GIMP. In the hands of good designers (and there are *many* designers who are better than me), GIMP can help in the creation of stunning images.

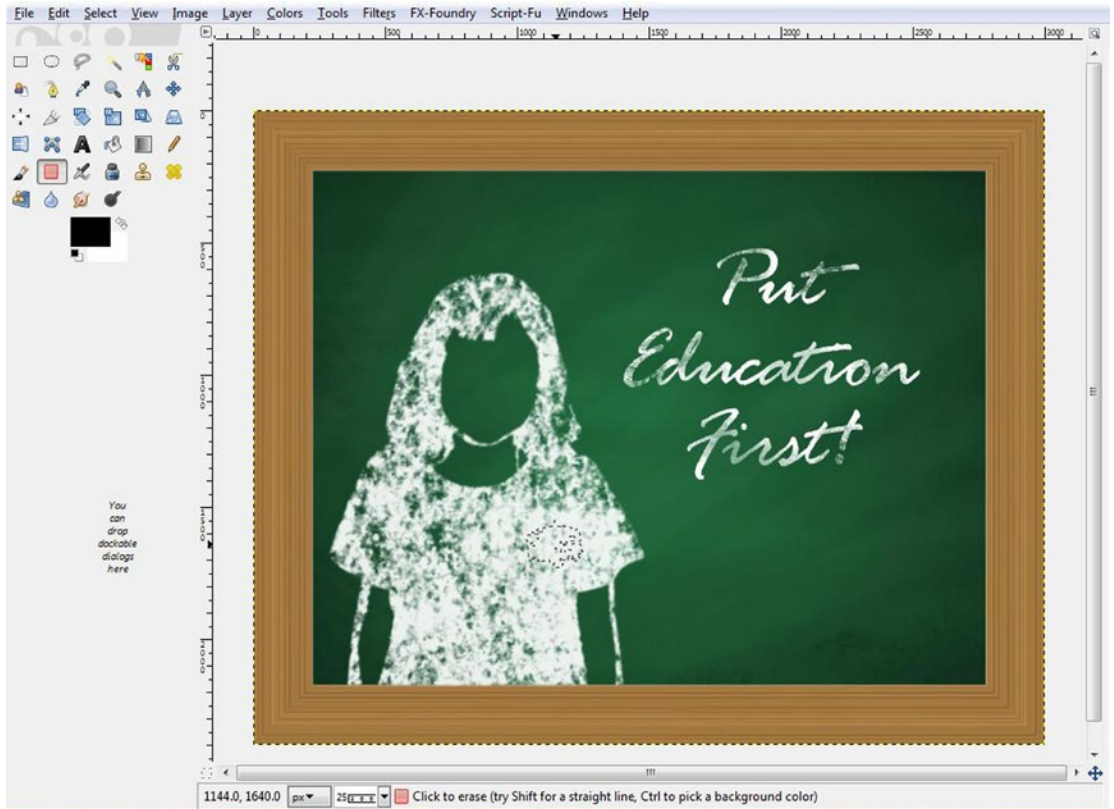

**Figure 4-16.** A graphic design I created entirely using GIMP

## GIMP Support

GIMP is a complex application, maybe not to the degree of Adobe Photoshop, but it is complex nonetheless. Beginners who first jump into this program can be overwhelmed with the wide array of functions and features. A great starting point (aside from becoming familiar with the *User Manual* in the *Documentation* section of the website) is visiting the tutorial section. There are tutorials for beginning, intermediate, and expert users. (Figure 4-17).

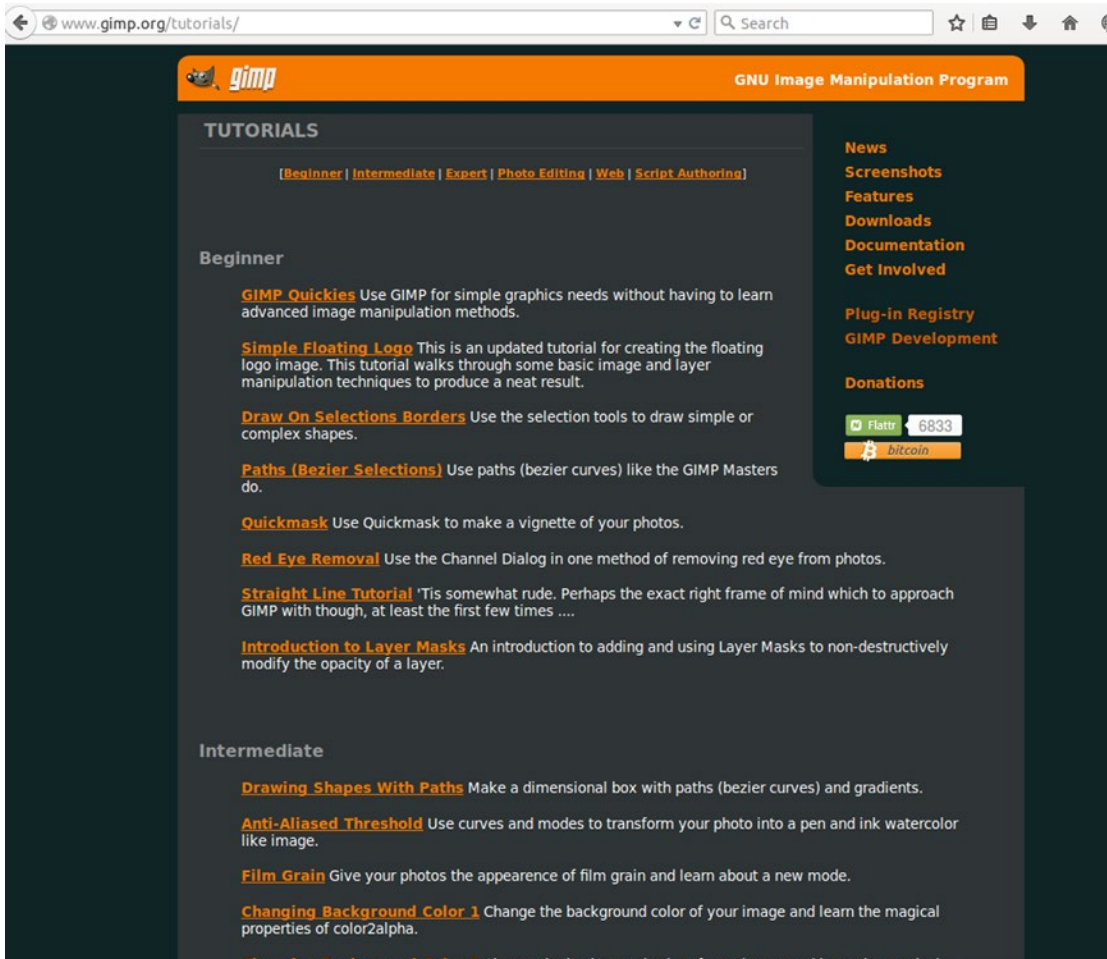

**Figure 4-17.** The tutorials section in the GIMP website is a great place for beginners to learn some GIMP basics

YouTube is also an excellent resource for learning GIMP. There are many video tutorials posted that will help the beginner come to grips with this powerful program. There are also a number of books about GIMP. Two great beginner's guides are *GIMP for Absolute Beginners* by Jan Smith with Roman Joost, and my previous book, *Beginning Photo Retouching and Restoration Using GIMP* (both published by Apress).

Yet another excellent resource to check out is *GIMP Magazine*, a free online publication. This magazine can be obtained for free either as downloaded PDF file or read online. It's a useful publication for photographers, graphics designers, or anyone wanting to learn more about GIMP. *GIMP Magazine* is available at [www.gimpmagazine.org](http://www.gimpmagazine.org).

# Autodesk Pixlr: Web-Based and Mobile Device Photo Editing

Pixlr is a family of photo editors that work in your computer's web browser or on mobile devices. There are three applications we'll look at: Pixlr Editor, Pixlr Express, and Pixlr O-Matic.

- **Alternative to:** Adobe Photoshop, Photoshop Elements
- **Website:** [www.pixlr.com](http://www.pixlr.com)
- **License:** Proprietary Freeware
- **Current Version:** Unspecified
- **Operating Systems:** Cross-platform (used in web browser or mobile devices)
- **Potential Savings:** \$19.99 per month (Photoshop subscription)

## Pixlr Editor

Pixlr Editor is a robust image editing tool that works in your web browser instead of downloading the software to your computer. It is similar to Paint.NET and GIMP in many respects. It offers a clone stamp and spot healing tool, drawing and painting brushes, layers, etc. Figure 4-18 shows the *Clone Stamp* tool being used to remove the plastic pail.



**Figure 4-18.** Using the Clone Stamp tool to remove the plastic pail

## Feature Highlights

Pixlr Editor offers many of the features one would expect from an editor as capable as this one:

- Plenty of editing tools such as *Clone Stamp*, *Spot Healing*, *Blur* and *Sharpen*, *Dodge* and *Burn*, etc.
- Layers, layer mask, and layer styles
- Red-eye removal tool
- History (for undoing edits performed several steps previously)

## Pixlr Express

Pixlr Express is a fun photo editor that works from your web browser or mobile device. This editor can handle minor photo fixes, and can add effects, overlays, borders, and text. The image in Figure 4-19 shows a photo with a film frame added to it.

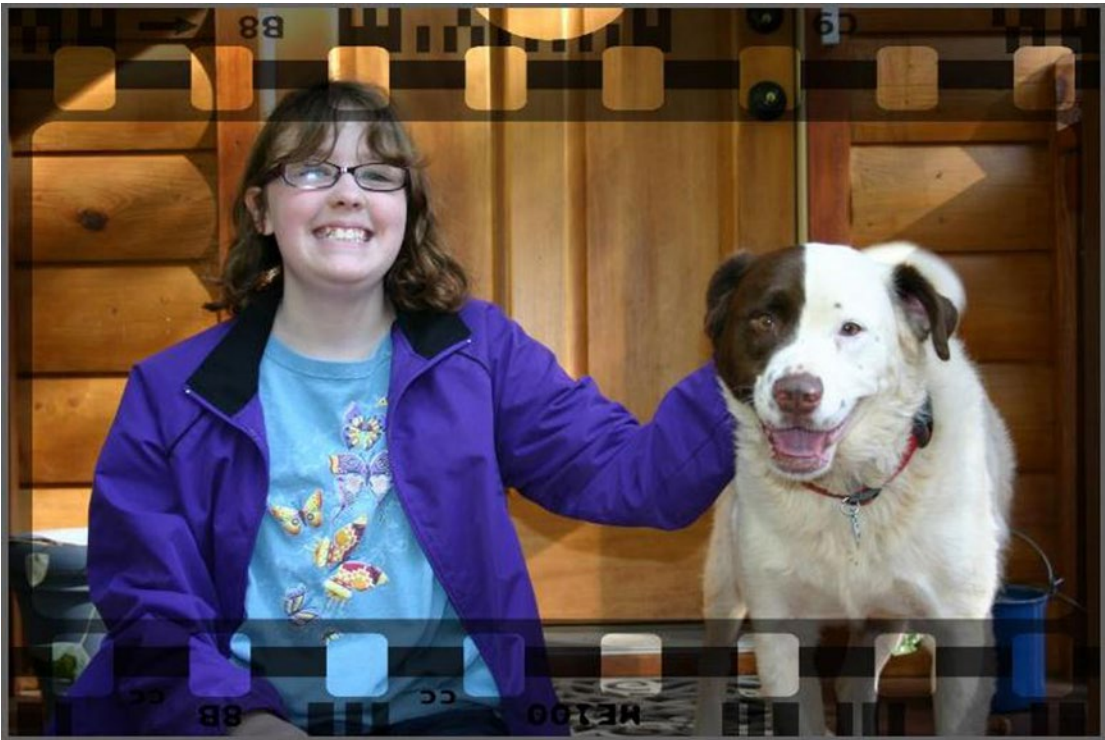

**Figure 4-19.** A film frame added using Pixlr Express

## Feature Highlights

Here's a quick look at some of the features offered in Pixlr Express:

- Adjustments including cropping, correcting brightness and contrast, and a quick-fix feature
- Effects for giving your photos stylized looks, such as vintage, soft, etc.
- Overlays including Bokeh, Fireworks, and Grunge
- Borders including Film, Ink, and Grunge
- Stickers
- Type (text)

## Pixlr O-Matic

Pixlr O-Matic is another fun editor, and ostensibly the simplest of the Pixlr family. Like Pixlr Express, it works from your web browser or mobile device. This editor is used to add vintage and retro effects to your images. Like Pixlr Express, it also offers an assortment of overlays and borders. Figure 4-20 shows a photo with an overlay applied.



**Figure 4-20.** An overlay effect added to the image

## Pixlr Support

The *Tutorials* page on the Pixlr website will probably provide you with enough support to get up to speed using Pixlr Express and Pixlr O-Matic. Both are very easy to use since most of the functions involve clicking a thumbnail to apply the edit to your image. Pixlr Editor, on the other hand, is a powerful image editor and might require additional learning resources. There are quite a few tutorial videos on YouTube that cover all three offerings of Pixlr.

## UFRaw: Open Source RAW Image Editing

UFRaw is a free, open source utility for reading and working with RAW images. RAW images are largely uncompressed, “pure” image data. RAW images are also known as digital negatives. UFRaw allows non-destructive editing of your images. UFRaw can be used as a stand-alone program or as a plug-in for GIMP. Figure 4-21 shows the program as a stand-alone application.

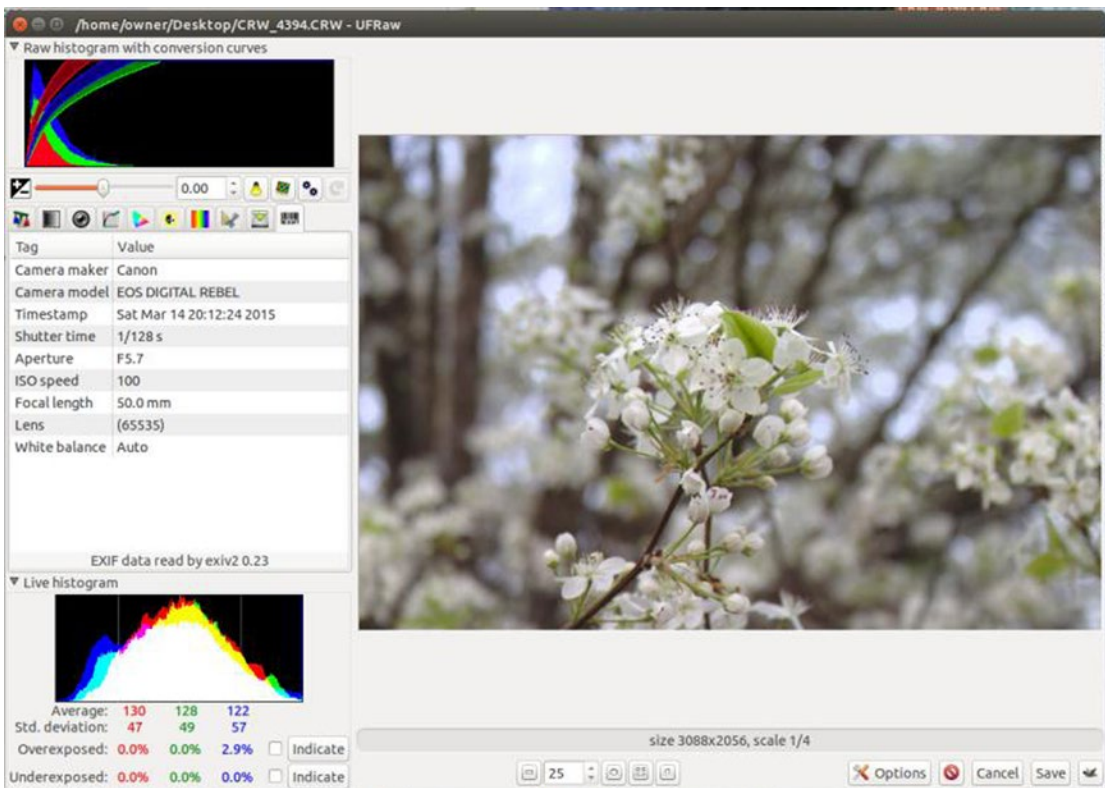

**Figure 4-21.** UFRaw shown as a stand-alone application (Used with permission © Udi Fuchs 2015)

Here are a few facts about UFRaw at a glance:

- **Alternative to:** Adobe Lightroom
- **Website:** [ufraw.sourceforge.net](http://ufraw.sourceforge.net)
- **License:** GPL

- **Current Version:** 0.19.2
- **Operating Systems:** Windows, Mac OS, Linux
- **Potential Savings:** \$9.99 per month (Lightroom subscription)

## Feature Highlights

UFRaw supports a wide variety of digital cameras, and offers a number of features that allow the processing of raw images:

- Exposure compensation
- Restore details for negative EV
- Clip highlights for positive EV
- Auto adjust exposure
- Denoise
- Grayscale mode
- Lens correction
- Base curve (imitates the functionality of Nikon's tone curve)
- Color matrix
- Correct (curve) luminosity/saturation
- Lightness adjustments
- Crop and rotate
- EXIF data information
- Live histogram

The live histogram can show you areas of overexposure or underexposure. The image in [Figure 4-22](#) shows that the blue color channel is overexposed by 2.9 %. By checking the *Indicate* box, black areas will flash on intermittently, showing which areas in the image are overexposed.

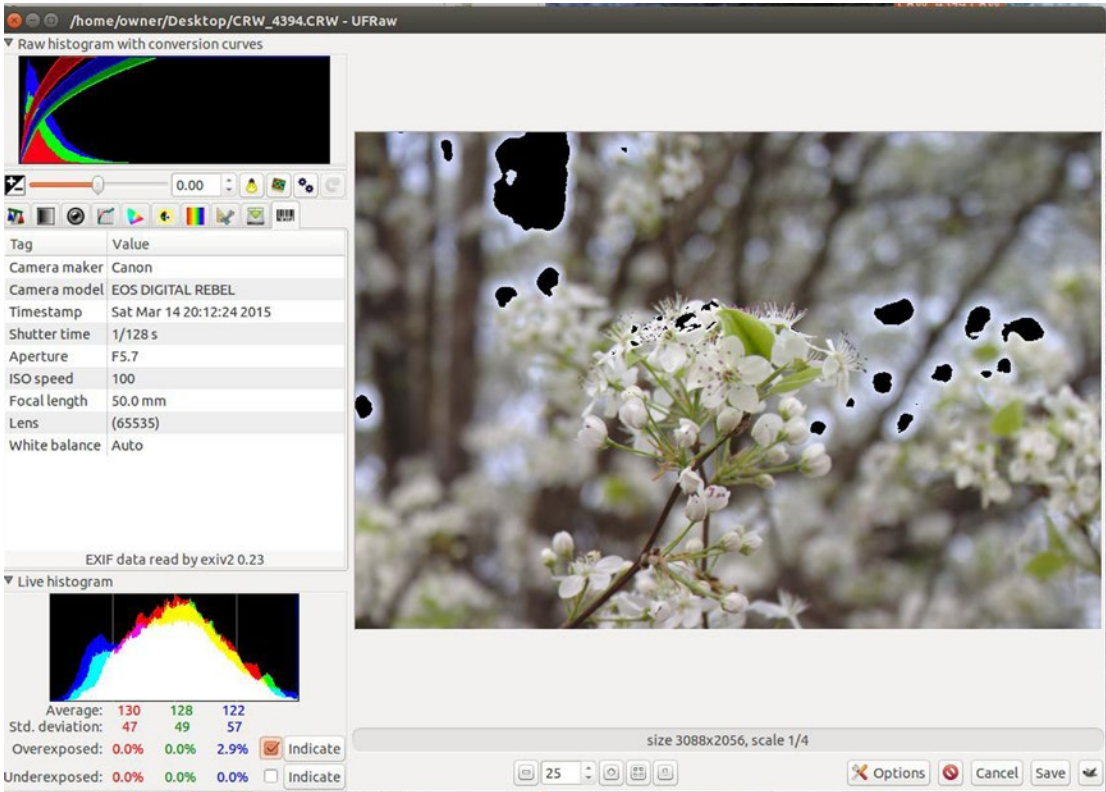

**Figure 4-22.** The overexposed parts of the image are indicated in the black areas. (Used with permission © Udi Fuchs 2015)

By using the *Correct Luminosity/Saturation* curve tool, the image is brightened up just a bit, with improved contrast (Figure 4-23). After editing your image, you can save it in the PPM, JPEG, PNG, or TIFF file format. You can also send it to GIMP (if you have it installed) to edit further by clicking the button on the bottom right (it will have Wilbur, the GIMP mascot, pictured as a small icon).

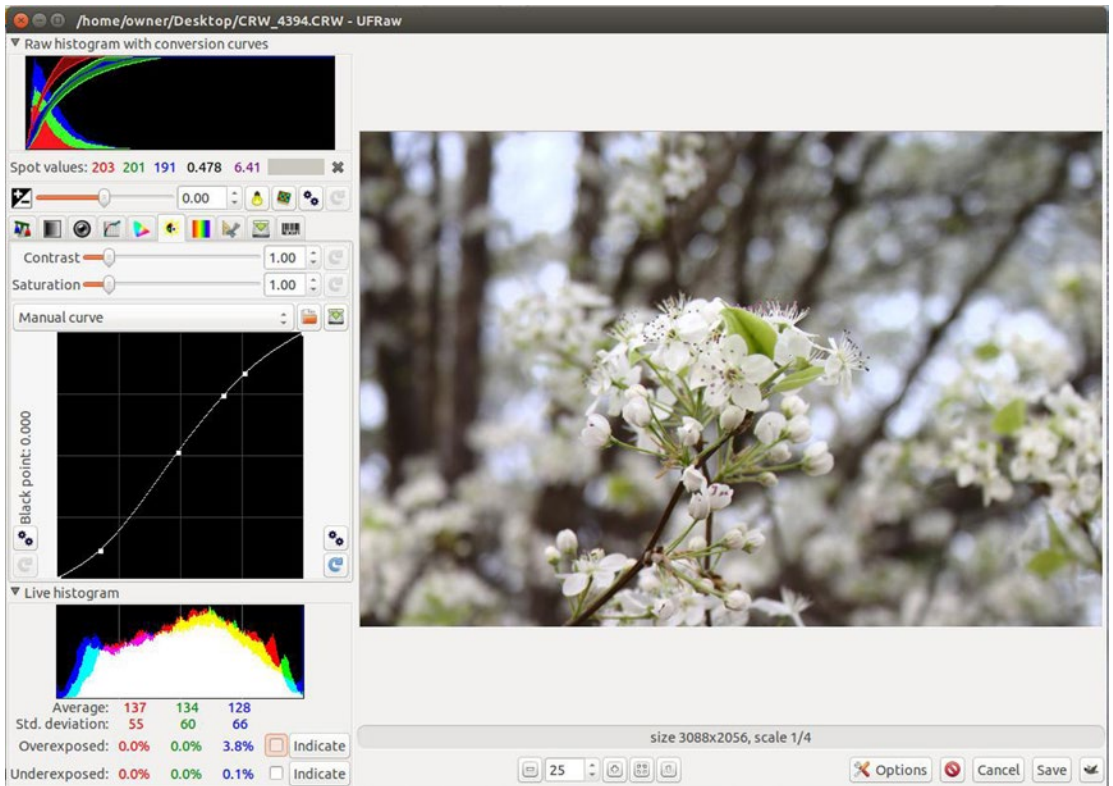

**Figure 4-23.** The Correct Luminosity/Saturation curve tool brightens the image and adds contrast. (Used with permission © Udi Fuchs 2015)

## UFRaw Support

Most of the information you need about UFRaw is in the *User Manual* on the website. There are several tutorial videos on YouTube as well. The discussion forum is also a helpful avenue to seek assistance if you encounter problems.

## FotoSketcher: Automatically Turn Photos into Digital Art

FotoSketcher is an easy-to-use program for the Windows platform that gives your photos an artistic look in just a few clicks of the mouse. You don't need much image editing knowledge; just open the image and apply the filter style you want. I've been using it for several years, and it comes in very handy for my work from time to time.

**Here are a few facts about FotoSketcher at a glance:**

- **Alternative to:** Corel Painter Essentials
- **Website:** [www.fotosketcher.com](http://www.fotosketcher.com)
- **License:** Proprietary Freeware
- **Current Version:** 3.0

- **Operating Systems:** Windows
- **Potential Savings:** \$49.99

FotoSketcher offers a variety of artistic filter styles such as oil painting, color pencils, watercolors, etc. Figure 4-24 shows a close-up of an oil painting style being applied to an image.

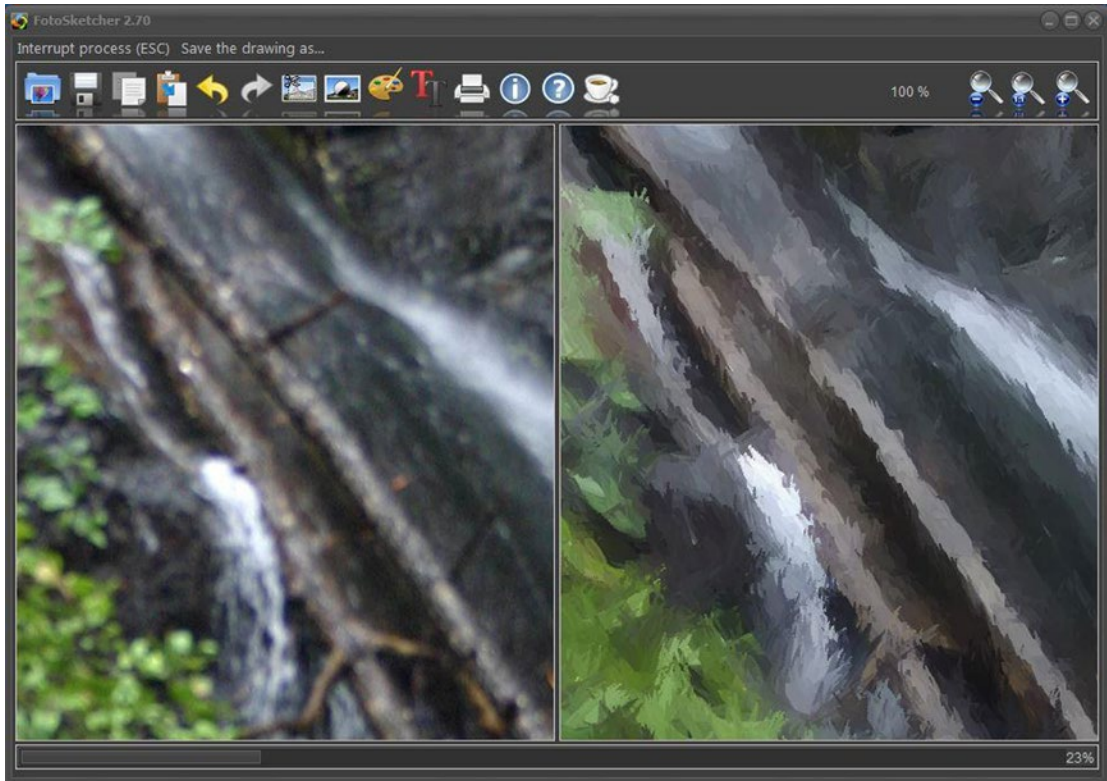

**Figure 4-24.** Close-up view of an oil paint filter being applied to an image (Used with permission © David Thoiron 2015)

## Feature Highlights

Rather than performing a wide range of functions, FotoSketcher’s primary purpose is converting photographic images into various types of digital art, so the list of highlights is rather short. Here’s how they read on the software provider’s website:

- 100% free
- More than 25 effects
- No artistic skill needed
- Over 6 million downloads
- Available in 23 different languages

## Editing Capabilities

FotoSketcher has a rudimentary editor to adjust certain aspects of the source image, such as luminosity (brightness), contrast, saturation, blur/sharpen, and median filter (Figure 4-25). After adjusting the source image the way you want, the program applies the filter you choose to create the desired outcome on a new target image, which you can save in the JPEG, PNG, or BMP format (the source image reverts to its original state after closing the program).

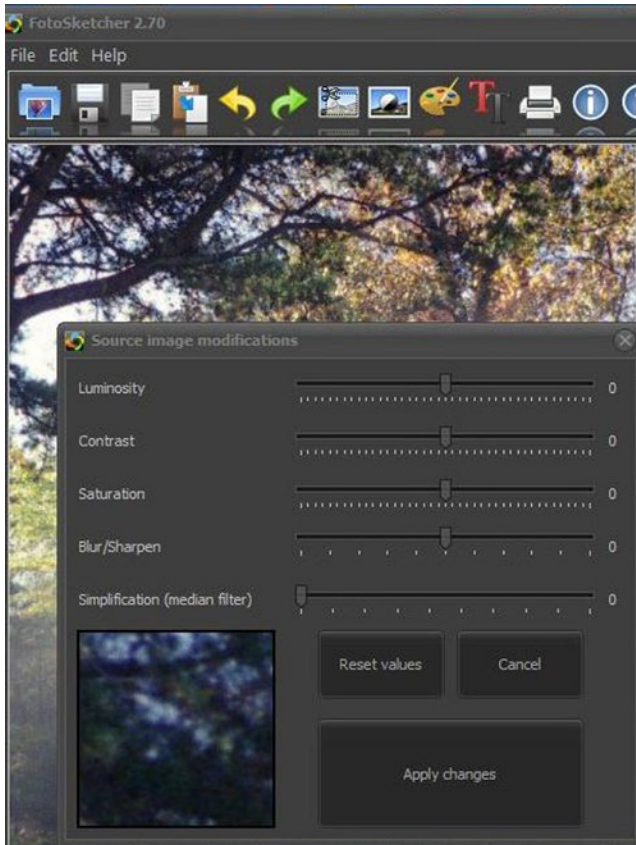

**Figure 4-25.** Close-up view of an oil paint filter being applied to an image (Used with permission © David Thoiron 2015)

The parameters of each artistic filter can be fine-tuned, and the results appear in the preview window (Figure 4-26). You'll be able to add a canvas-like texture, soften the image edges, and a frame if you like. After applying the *Draw* command, you can undo the command to reset the image if you don't like the results.

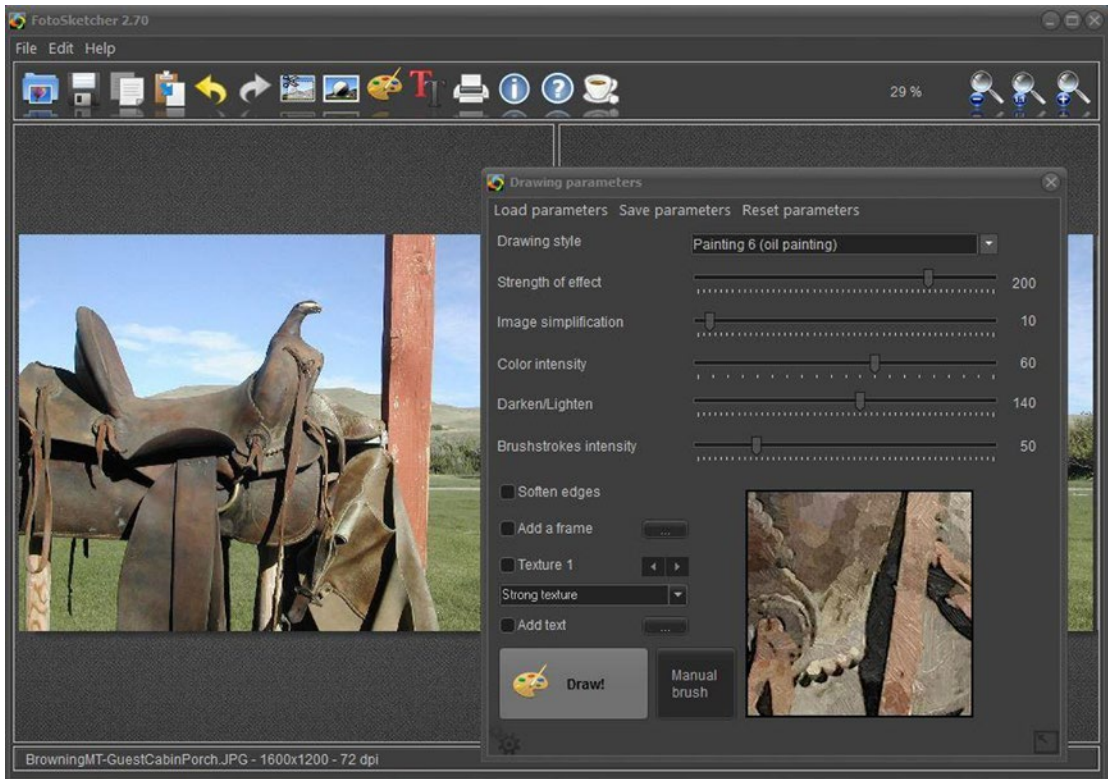

**Figure 4-26.** The parameters of each artistic filter can be fine tuned. (Used with permission © David Thoiron 2015)

FotoSketcher also has a text editor, which can be used to create and customize images for marketing materials. Figure 4-27 shows the image of the saddle with the *Vintage* filter applied and text added.



**Figure 4-27.** FotoSketcher includes a Text editor. (Used with permission © David Thoiron 2015)

## FotoSketcher Support

This program is really easy to use. However, you'll probably need to spend a little time experimenting with the filter parameters to achieve the results you want. The *Help* section of the website consists of two instructional videos (and there are numerous tutorials on YouTube as well).

---

■ **Note** FotoSketcher should not be confused with PhotoSketcher, a paid Mac OS application. Although they are similar, the latter specializes in turning photos into digital pencil sketches. Along with FotoSketcher, there are several video tutorials about PhotoSketcher on YouTube, so it's a good idea to pay attention to the spelling when using the keyword search box.

---

## Summary

In this chapter, you looked at some useful free and free open source solutions for photo editing. PhotoScape is an easy-to-use editor with plenty of features. Paint.NET is a step up in functionality, reminiscent of Photoshop but far less complex. GIMP is arguably the most powerful and full-featured open source image editing program, and it is used by enthusiasts and professionals worldwide. Autodesk offers the Pixlr family of web-based and mobile device solutions for editing images and adding effects. UFRaw is an open source utility for reading and working with RAW digital images. It works as a stand-alone program or as a plug-in for GIMP. FotoSketcher is a great tool for converting digital photos into various types of art.

## CHAPTER 5



# Audio-Video Capture, Conversion, and Editing Software

The prevalence of video hosting sites such as YouTube affords the opportunity for small businesses to get their message out in a way not possible in the not-too-distant past. It's possible to digitize old radio commercials from cassette tapes or make your own commercials, tutorials, or slide shows for posting on the Web. For the business owner who is a novice when it comes to working with audio and video, there are some no-cost options for capturing, converting, and editing audio and video files.

Here's a quick look at the software programs covered in this chapter:

- **fre:ac (Free Audio Converter):** An open source program for ripping audio files from compact discs and converting WAV files into compressed audio files
- **Audacity:** An easy-to-use yet powerful open source audio editing tool for capturing and editing audio files
- **MPEG Streamclip:** A handy freeware tool for video format conversion
- **Windows Movie Maker:** A free video editing tool for Windows
- **VirtualDub:** A free open source video capture and processing tool for Windows
- **Kdenlive:** A powerful open source video editor for Linux and Mac OS

## fre:ac (Free Audio Converter): An Open Source Audio CD Ripping Program

fre:ac is a handy, lightweight program for extracting the audio files from compact discs so they can be archived on your computer. It's primarily used for backing up files from music CDs, but it certainly has potential business applications such as archiving files from company training CDs, orientation CDs, etc.

**Here are a few facts about fre:ac at a glance:**

- **Alternative to:** illustrate dBpoweramp CD Ripper
- **Website:** [www.freac.org](http://www.freac.org)
- **License:** GPL
- **Operating Systems:** Windows, Mac OS X, Linux, and Free BSD
- **Potential Savings:** \$39.00 (single user)

■ **Note** It's important to make sure you are working within the law when using this type of software. For example, if you own a business and are the legal copyright owner of the contents of an old training CD that was produced years earlier, then you are within your rights to copy and distribute the contents. If someone else owns the rights, then you need to obtain written permission to copy and use those files. When in doubt, check with your attorney.

Upon launching the program, a *Tip of the day* window pops up (Figure 5-1). You can disable it if you wish, but it's a good idea to read the tips to help familiarize yourself with the functions and features fre:ac offers.



**Figure 5-1.** The *Tip of the day* window displays upon launching fre:ac. (Used with permission © Robert Kausch 2015)

## Feature Highlights

This program is a lightweight application with the primary functions of ripping files from CDs and converting audio files. Here's rundown of its features as listed on the fre:ac website:

- Converter for MP3, MP4/M4A, WMA, Ogg Vorbis, FLAC, AAC, WAV, and Bonk formats
- Integrated CD ripper with CDDb/freedb title database support
- Portable application, so you can install on a USB stick and take it with you

- Multicore optimized encoders to speed up conversions on modern PCs
- Full Unicode support for tags and file names
- Easy to learn and use, and still offers expert options when you need them
- Multilingual user interface available in 40 languages
- Completely free and open source without a catch

Figure 5-2 shows the workspace, displaying the files of royalty-free production music contained on a CD. By default, all of the tracks are selected but you can deselect the boxes of the files you don't want to rip.

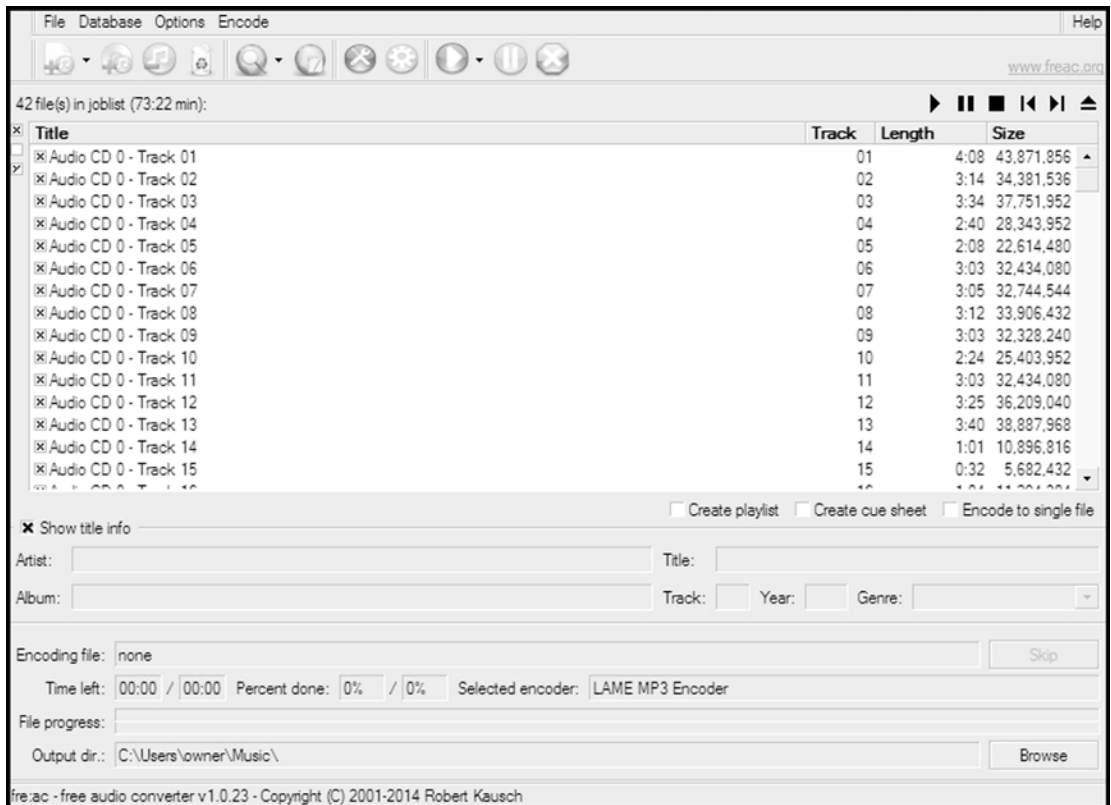

**Figure 5-2.** You can rip all of the files from a CD at once, or deselect the ones you don't need. (Used with permission © Robert Kausch 2015)

Audio files can be converted from one format into another. There are spaces to add information such as the artist, track title, album, and music genre. Figure 5-3 shows the progress of converting a file into a LAME MP3 file. LAME refers to a free software codec used to compress audio into the lossy MP3 format.

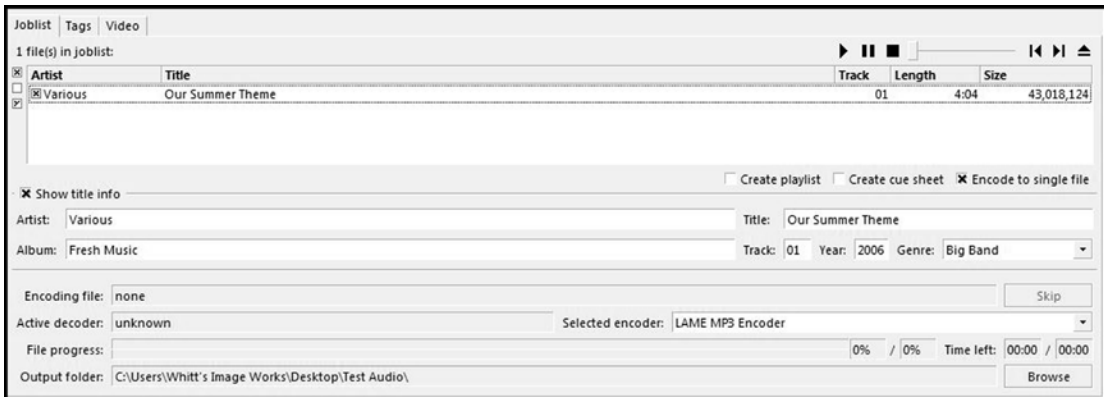

**Figure 5-3.** A file being converted into the LAME MP3 format (Used with permission © Robert Kausch 2015)

## fre:ac Support

Unfortunately, there's not much in the way of documentation on the website other than the FAQ page. For that matter, there are only a handful of tutorial videos on YouTube. However, there is a *Beginner's Manual* as a PDF that can be downloaded from <ftp://193.169.37.88/Soft/PortableSoft/LiberKey/Apps/Freac/App/Freac/manual/en/beginner.html>.

Of course, this application is lightweight and easy to use. What the web site's documentation lacks should be well covered in the PDF manual.

## Audacity®: A Powerful, Open Source Audio Editor

Audacity is a very popular open source program for editing audio files. It's not in the same league as professional audio editing packages used in the music industry, but it is certainly a great program for importing, exporting, and improving audio files.

**Here are a few facts about Audacity at a glance:**

- **Alternative to:** Apple Logic Pro
- **Website:** <http://web.audacityteam.org>
- **License:** GPL
- **Operating Systems:** Windows, Mac OS, Linux
- **Potential Savings:** \$199.99

Audacity is an easy-to-use multitrack editor. It's availability for use on Windows, Mac OS, and Linux, making it a widely used program by enthusiasts and pros on a budget.

## Feature Highlights

To see the long list of Audacity's features, click the *Features* tab on the website (<http://web.audacityteam.org/about/features>). The following is a quick rundown of several features as described on the website:

- Record live audio
- Record computer playback on any Windows Vista or later machine
- Convert tapes and records into digital recordings or CDs
- Edit WAV, AIFF, FLAC, MP2, MP3, or Ogg Vorbis sound files
- AC3, M4A/M4R (AAC), WMA, and other formats supported using optional libraries
- Cut, copy, splice, or mix sounds together
- Numerous effects including changing the speed or pitch of a recording

Audacity is primarily a tool used for music production. However, it has other practical applications beneficial to the business owner. Some businesses recycle advertisements from years past. If the advertisement is generic enough, it's possible to use it indefinitely. Audacity is a great tool to digitize radio spots that are stored on old audio cassettes (Figure 5-4). The audio files can be incorporated with video or still images, posted on your company website, Facebook, YouTube, or any number of sites to further extend the advertisement's usefulness.



**Figure 5-4.** Audacity can digitize old radio ad spots for reuse

Of course, it's also great for archiving your old personal music collection and childhood audio recordings.

---

■ **Note** If you plan to repurpose old radio spots, it's best make sure you own the rights to those spots. If it is unclear, obtain (written, if possible) permission from the manager of the station that produced and broadcasted them. When in doubt, check with an attorney.

---

Audacity can record audio by connecting one end of a patch cord to the line-in jack of your computer, and the other to a play-back device (such as a cassette player). Figure 5-5 show the record button used to capture audio once the playback equipment is connected.

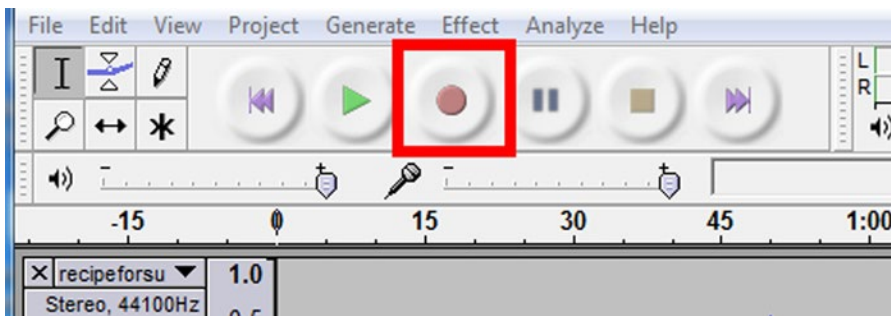

**Figure 5-5.** Audacity's Record button for recording audio from playback devices (Used with permission © The Audacity Team 2015)

## Editing Capabilities

With Audacity, you can perform a number of editing tasks, such as importing audio, trimming away unwanted portions, and applying filters to modify or clean up the sound. There are many audio filters available for a wide range of purposes (Figure 5-6).

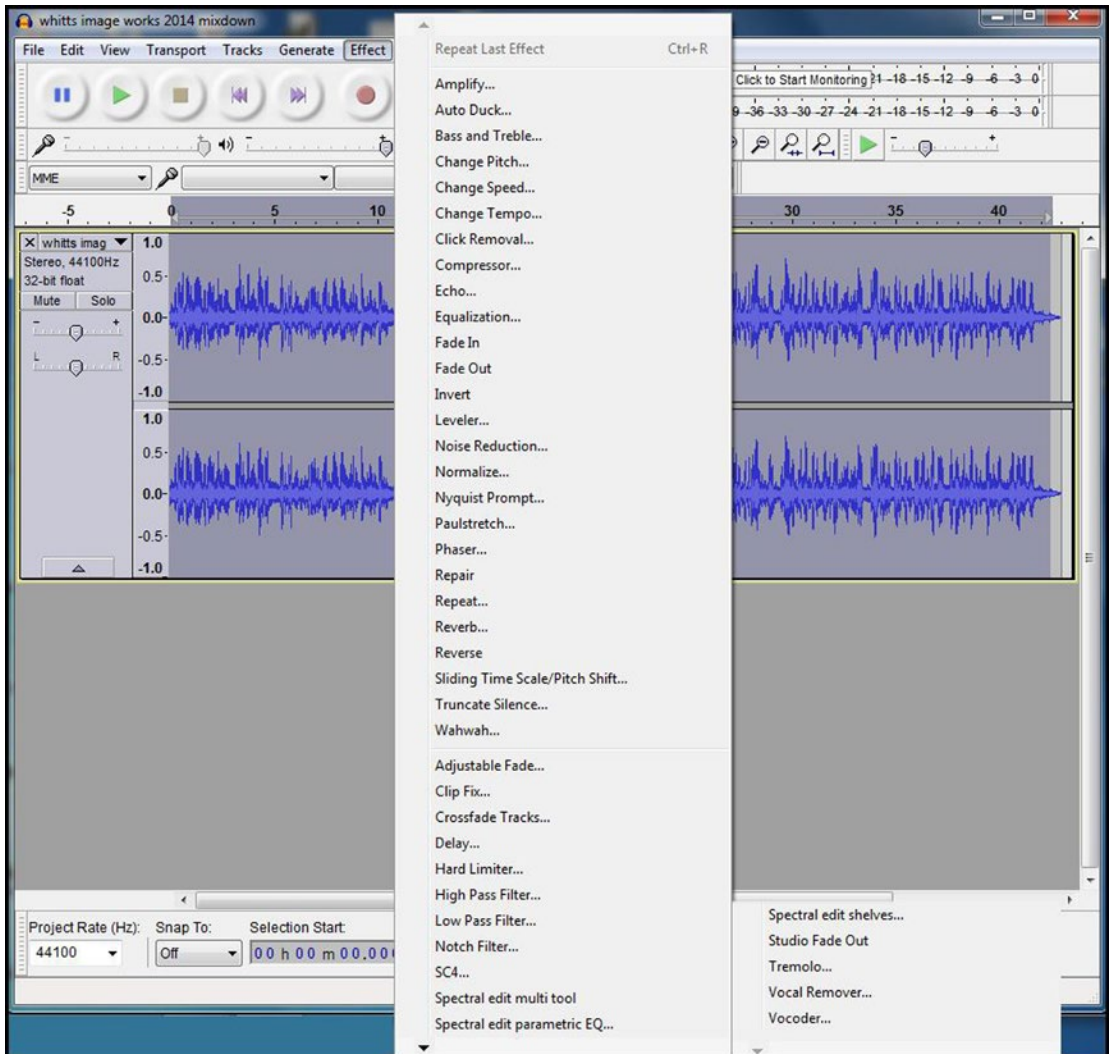

**Figure 5-6.** The Effects menu in Audacity contains many filters. (Used with permission © The Audacity Team 2015)

---

■ **Note** Audacity does not import or rip files from compact discs. Also, Audacity does not directly support MP3 conversion and an additional library must be installed to export MP3 files.

---

Mono tracks can be split into stereo tracks. Although it's not true stereo, the file will exist on a left and right channel, each of which can be independently edited. Conversely, stereo tracks can be merged into a single track and can be output as mono.

Audacity can also generate click tracks, which are audio cues to aid in timing in recording music. Click tracks are also used as a means of synchronizing audio to moving images (Figure 5-7).

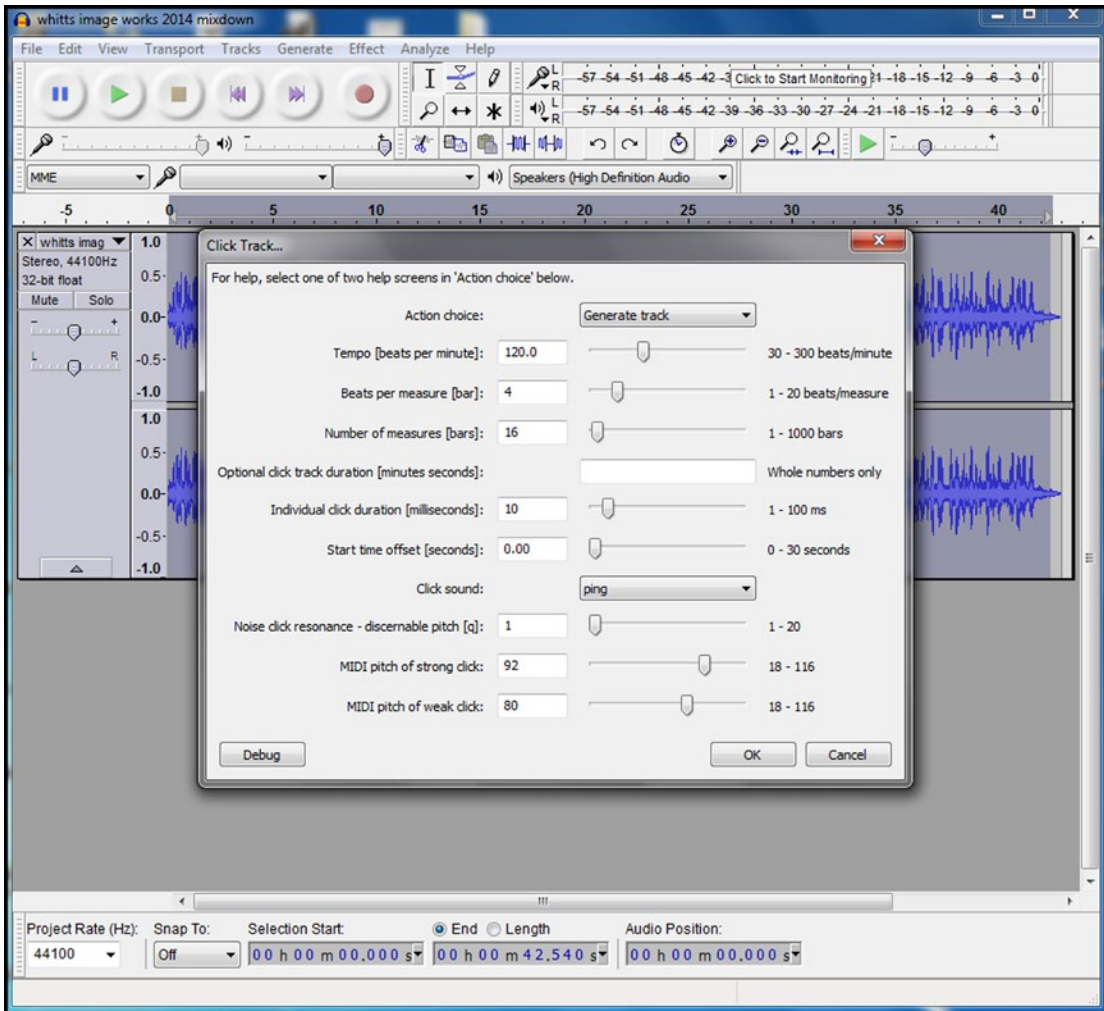

**Figure 5-7.** Audacity's Click Track dialog offers many options. (Used with permission © The Audacity Team 2015)

## Audacity Support

Audacity is a popular program, so there's plenty of help available. The *User Manual* on the Audacity website ([http://manual.audacityteam.org/o/quick\\_help.html](http://manual.audacityteam.org/o/quick_help.html)) is the best starting point to familiarize yourself with the basics (Figure 5-8). There are beginning tutorials, and the FAQ page provides a lot of information. YouTube has numerous tutorial videos as well, but some of them may be for older versions. Up-to-date tutorials can be found here: <http://wiki.audacityteam.org/wiki/Category:Tutorial#external>.

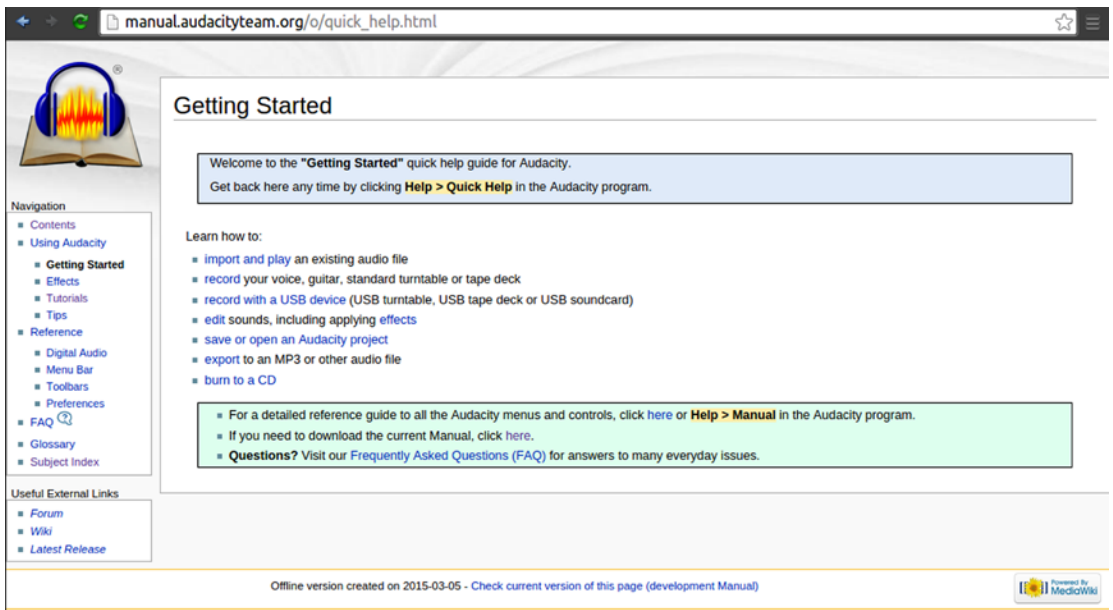

**Figure 5-8.** The Audacity User Manual is a great starting point to get familiar with this program. (Used with permission © The Audacity Team 2015)

## MPEG Streamclip: A Handy, Free Video Conversion Tool

MPEG Streamclip is a useful, lightweight program primarily for converting standard definition video files from one format into another. It also offers some rudimentary editing features. One of this program's uses is converting larger video files (such as AVI) into formats suitable for playback on mobile devices.

### Here are a few facts about MPEG Streamclip at a glance:

- **Alternative to:** AVS Video Converter
- **Website:** [www.squared5.com](http://www.squared5.com)
- **License:** Proprietary Freeware
- **Current Version:** 1.2
- **Operating Systems:** Windows, Mac OS
- **Potential Savings:** \$69 (annual subscription to AVS4You.com)

It should be mentioned that there is one caveat that accompanies the use of MPEG Streamclip; it requires that QuickTime Alternative is installed on your computer. This, however, isn't a huge obstacle. QuickTime Alternative can be downloaded (for free) from the following link on Codecs.com:

[www.free-codecs.com/download/quicktime\\_alternative.htm](http://www.free-codecs.com/download/quicktime_alternative.htm).

## Feature Highlights

MPEG Streamclip's are listed in detail on the Squared 5 website. Here is the abridged version (and reformatted into a bullet list) of this program's features from the website:

- Play and edit file formats such as QuickTime, DV, AVI, MPEG-4, MPEG-1, MPEG-2, or VOB.
- Transport streams with MPEG, PCM, or AC3 audio to QuickTime, DV, AVI/DivX, and MPEG-4 with high quality encoding and even uncompressed or HD video.
- Video conversion is performed in the YUV color space.
- Other optional video processing features include a powerful motion-adaptive deinterlacer, a field dominance converter, a chroma reinterlacer, and an option to perform interlaced scaling instead of progressive scaling.
- Audio can be converted to uncompressed or to IMA, AAC, MP2, or AMR using the high-quality MP1/MP2/AC3/PCM built-in decoders of MPEG Streamclip; it is also kept in perfect sync with video using a timekeeping system.
- Save edited movies as MOV files, and (when possible) as AVI or MP4 files. Edited MPEG-1 or MPEG-2 files are saved as MPEG or TS files.
- Convert MPEG-2 transport streams into muxed MPEG-2 files for immediate burning at full quality with most DVD authoring applications.
- Handle files and streams larger than 4 GB, split in any number of segments, or with multiple audio tracks, and can also optionally handle timecode breaks. It is compatible with MPEG-1 and MPEG-2 video, MPEG layer 1/2 (MP1/MP2) audio, AC3/A52 audio, and PCM audio.
- The player lets you preview the files and transport streams before doing the conversion; it also lets you visually set the In and Out points for the conversion so you can convert just the part of the file you are interested in.

Once QuickTime Alternative is installed, upon launching MPEG Streamclip the workspace window appears with the Squared 5 logo in the center (a square with five small circles).

For file conversions, it's essentially a matter of choosing the output format you want. There is a menu with choices of frame size, compression quality, and others options depending on the format chosen. MPEG Streamclip can come in handy for converting larger video formats into MPEG-4 files, commonly used on mobile devices (Figure 5-9)



**Figure 5-9.** Larger video formats can be converted to MPEG-4, which is used on mobile devices

## Editing Capabilities

MPEG Streamclip offers only limited editing functions. It is possible to set In and Out points so that only the desired portions of the movie are converted to the new file. There is an *Adjustments* dialog box for adjusting the brightness, contrast, saturation (Figure 5-10), and volume of the movie. There is also an option to add basic text as a watermark that appears in the lower right hand corner of the video frame.



**Figure 5-10.** Brightness is improved using the *Adjustments* dialog box

## MPEG Streamclip Support

There's no real documentation on the Squared 5 website to speak of (other than the *Features* page and the website itself), but there is an MPEG Streamclip *User's Guide* available as a downloadable PDF from <https://people.ok.ubc.ca/creative/Mbtemp/MPEG%20Streamclip%20User%27s%20Guide.pdf>.

Fortunately, YouTube has plenty of instructional videos, many of which are introductory tutorials. MPEG Streamclip is a simple enough program to ensure there's no shortage of learning resources for it.

# Windows Movie Maker: The Free Microsoft Video Editing Tool

Many of the small business owners I come into contact with are, by their own admission, not technically inclined. I'm often surprised at how often I talk with Windows users who aren't aware that Movie Maker may already be installed on their computer, or that it can be downloaded for free from Microsoft. Although those people are probably a small minority, I felt it important to touch on this program.

Movie Maker has made some notable strides since its early days. It can be a valuable tool for creating videos to output to DVD or post on Facebook and YouTube.

## Here are a few facts about Windows Movie Maker at a glance:

- **Alternative to:** Adobe Premier Elements
- **Website:** <http://windows.microsoft.com/en-US/windows-live/movie-maker>
- **License:** Proprietary Freeware
- **Current Version:** 12
- **Operating Systems:** Windows
- **Potential Savings:** \$99.99

If Microsoft Movie Maker is not currently installed on your computer, it can be acquired from the Movie Maker download page at <http://windows.microsoft.com/en-us/windows-live/movie-maker>.

## Feature Highlights

Movie Maker offers a variety of features to help you create a polished production. The following list provides an overview:

- Import existing video files, audio files, and pictures into Movie Maker
- Import video files from your digital video camera
- Add a variety of transitions and effects to your production
- Add titles and credits to your production
- Output your movie in a variety of ways, such as on DVD or YouTube

## Editing Capabilities

With Movie Maker, you can give your movies a professional look by adding titles and text (Figure 5-11). Effects and transitions can be added to further refine your movie production. Although it doesn't have any adjustments for color correction (although there are a few work-around solutions on YouTube), Movie Maker has a rudimentary brightness adjustment to brighten dark, underexposed video.



**Figure 5-11.** A title similar to this can be added to a video production for a professional touch

Movie Maker allows you to choose the resolution of your video, which is helpful for posting your movie on sites such as Facebook or YouTube (Figure 5-12).



**Figure 5-12.** Windows Movie Maker offers several options for choosing the resolution of your movie; a few example resolutions are shown here

There are several output options for your movie production available, such as DVD (Figure 5-13) high definition display, computer display, e-mail, and mobile devices.



**Figure 5-13.** Windows Movie Makers offers numerous choices to output your movie, including DVD

## Windows Movie Maker Support

Windows Movie Maker is a fairly easy program to use, but there are several good resources to help you if you encounter problems using this application, or if you have a desire to be more creative with your productions. Blaine's Movie Maker Blog (<http://movies.blainesville.com/>) is a helpful resource, with just about all the information you'd need to make the most of your videos using Movie Maker (Figure 5-14). There are also a number of good tutorial videos on YouTube to help get you up and running.



**Figure 5-14.** *Blaine's Movie Maker Blog is a great learning resource for becoming familiar with Movie Maker to make the most of your video*

## VirtualDub: Open Source Video Processing for Windows

We looked at the features offered in Windows Movie Maker, which are probably sufficient for many people making their own business videos. VirtualDub offers a few features not found in Movie Maker, and this makes it an excellent companion program (but it can be used as a basic editor in its own right).

### Here are a few facts about VirtualDub at a glance:

- **Alternative to:** Adobe Premier Elements
- **Website:** [www.virtualdub.org](http://www.virtualdub.org)
- **License:** GPL
- **Current Version:** 1.10.4
- **Operating Systems:** Windows
- **Potential Savings:** \$99.99

VirtualDub is really more of a video capture and processing tool than it is a general purpose video editor. Among its strengths are filters such as *Levels*, *Hue/Saturation/Value*, and many others. VirtualDub can make color enhancements and improve exposure in less-than-perfect video clips (Figure 5-15).

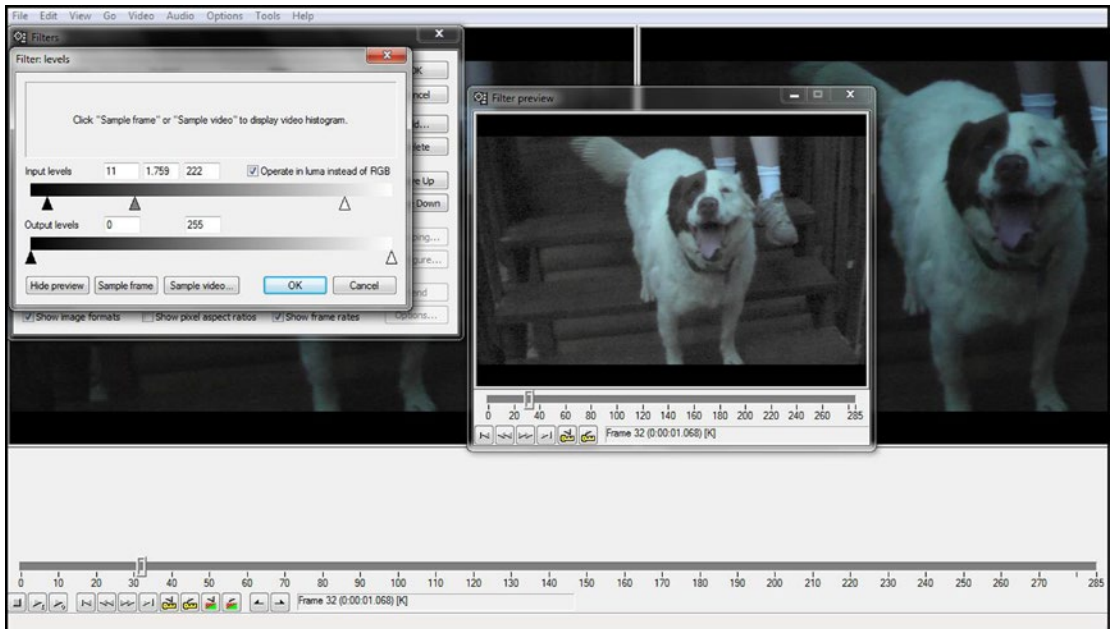

**Figure 5-15.** Improving a dark video using the Levels filter within VirtualDub

---

■ **Note** It's helpful to have a video capture card or device that captures video as AVI files to your computer. Otherwise, you can use a free program like MPEG Streamclip (also covered in this chapter) to convert other formats to an AVI file in order to use VirtualDub.

---

## Feature Highlights

VirtualDub has an extensive list of features primarily for managing AVI files. I've listed them here as they are shown on the website, although a couple of them are slightly abridged:

- Fractional frame rates
- Optimized disk access for more consistent hard disk usage
- Create AVI2 (OpenDML) files to break the AVI 2GB barrier and multiple files to break the FAT32 4GB limit
- Integrated volume meter and histogram for input level monitoring
- Real-time downsizing, noise reduction, and field swapping
- Verbose monitoring, including compression levels, CPU usage, and free disk space
- Access hidden video formats your capture card may support but not have a setting for, such as 352x480
- Keyboard and mouse shortcuts for faster operation (such as just hit F6 to capture)
- Clean interface layout: caption, menu bar, info panel, status bar

- Read and write AVI2 (OpenDML) and multi-segment AVI clips
- Integrated MPEG-1 and Motion-JPEG decoders
- Remove and replace audio tracks without touching the video
- Extensive video filter set, including blur, sharpen, emboss, smooth, 3x3 convolution, flip, resize rotate, brightness/contrast, levels, deinterlace, and threshold
- Bilinear and bicubic resampling so no blocky resizes or rotates here
- Decompress and recompress both audio and video
- Remove segments of a video clip and save the rest without recompressing
- Adjust frame rate, decimate frames, and 3:2 pulldown removal
- Preview the results with live audio

## Editing Capabilities

VirtualDub is somewhat limited when compared to a more full-featured program. For example, video processed using this software requires a separate authoring program to write a DVD. Another limitation is the fact that it only handles Microsoft AVI files. Although it does have some editing features, it could be used to augment Movie Maker.

However, it does offers a generous filter set to improve video quality and to add a variety of effects. The preview window provides a side-by-side comparison of the original dark video (Figure 5-16).

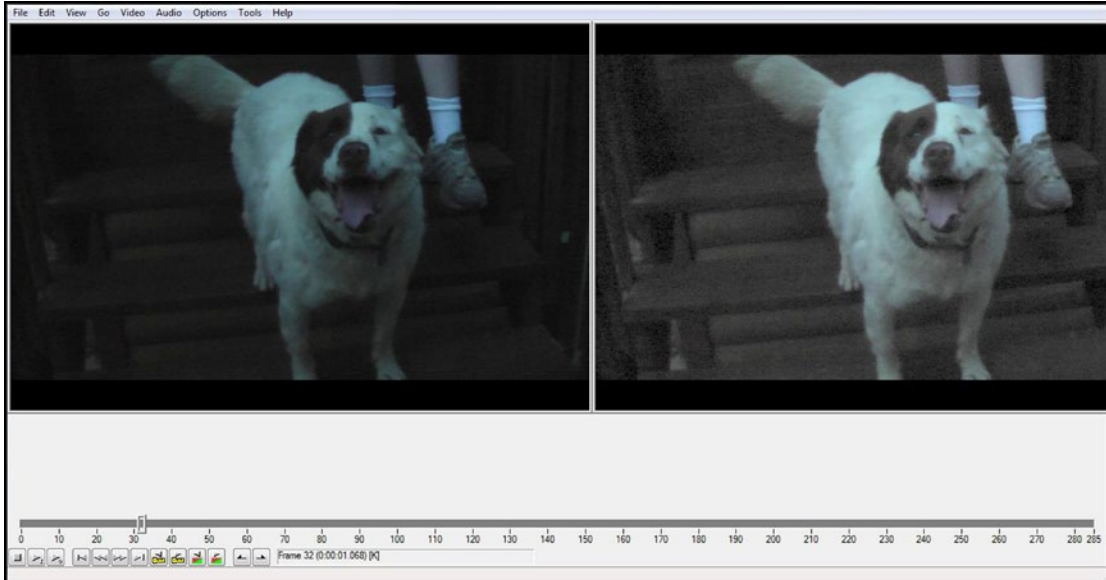

**Figure 5-16.** Side-by-side comparison of original video and the clip with a filter applied

■ **Note** Although VirtualDub already has a large filter set, there are even more third-party filters available to download from providers such as [majorgeeks.com](http://majorgeeks.com).

VirtualDub also allows the placement of logos or images over a video clip. In Figure 5-17, I placed a simplified version of my logo over a sample clip of a film transfer done recently (I post sample clips on YouTube to help me promote my film conversion services). I created the logo using GIMP 2.8, and exported it in the PNG file format with a transparent background.



**Figure 5-17.** A logo added to a video clip in VirtualDub

VirtualDub also allows you to remove unwanted sections of video to create a new, edited clip by using the *Mark In* and *Mark Out* feature. You can also remove existing audio tracks and replace them with new ones if needed. After the video clip has been processed and edited, you can save it as a new AVI file.

## VirtualDub Support

There are quite a few video tutorials on YouTube that will help the new user get acquainted with VirtualDub. I recommend taking some time to watch these if you are new to video editing. There is also a support forum on the official VirtualDub website.

# Kdenlive: The Open Source Video Editor for Linux and Mac OS

Kdenlive is feature-rich, free, open source video editor developed primarily for several Linux distributions, but is also available for Mac and FreeBSD (a derivative of UNIX).

**Here are a few facts about Kdenlive at a glance:**

- **Alternative to:** Adobe Premier, Final Cut Pro X
- **Website:** [www.kdenlive.org](http://www.kdenlive.org)
- **License:** GPL
- **Current Version:** 15.04.0 (0.9.10 recommended for Ubuntu Linux)
- **Operating Systems:** Linux, Mac OS, FreeBSD
- **Potential Savings:** \$99.99

Kdenlive is capable of producing basic video clips, but is also powerful enough for semi-professional work. It supports DV, AVCHD, and HDV editing. Figure 5-18 shows a video clip in the timeline of Kdenlive.

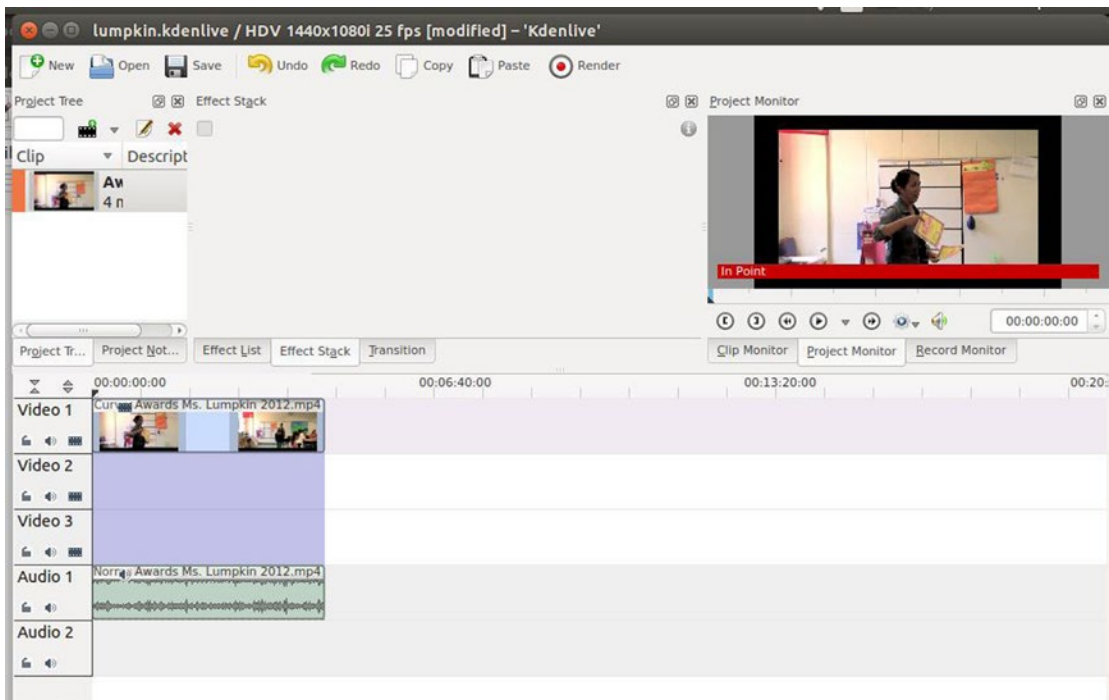

**Figure 5-18.** A video clip in the Kdenlive timeline

## Feature Highlights

Kdenlive boasts functions for the creative film maker. The full list can be found on the *Features* page of the Kdenlive website. The following list is a condensed, quick overview of the features from the Kdenlive website:

- Mix video, audio, or image files supported by Kdenlive
- Support for a wide range of cameras including RAW and DV editing, MPEG2, MPEG4, and H264 AVCHD
- Multitrack edition with a timeline and unlimited number of video and audio tracks
- Video and audio tracks organized in layers
- Tools to create, move, crop and delete video clips, audio clips, text clips, and image clips
- Configurable keyboard shortcuts and interface layouts
- A wide range of effects and transitions plus the ability to add custom effects and transitions
- Non-blocking rendering using a rendering separate application which allows you to stop, pause, and restart rendering so you can continue to work on your project without any possible loss of data
- Export to standard formats: DV (PAL and NTSC); MPEG-2 (PAL, NTSC, and HDV) and AVCHD (HDV); High-quality h264; and non-destructive formats

## Editing Capabilities

Kdenlive offers some tools normally found in high-end video editing programs. There are tons of effects for working with audio, adjusting contrast, adding fun effects, etc. Figure 5-19 shows the Effect list (clicking the small triangle reveals the functions nested under each effect heading).

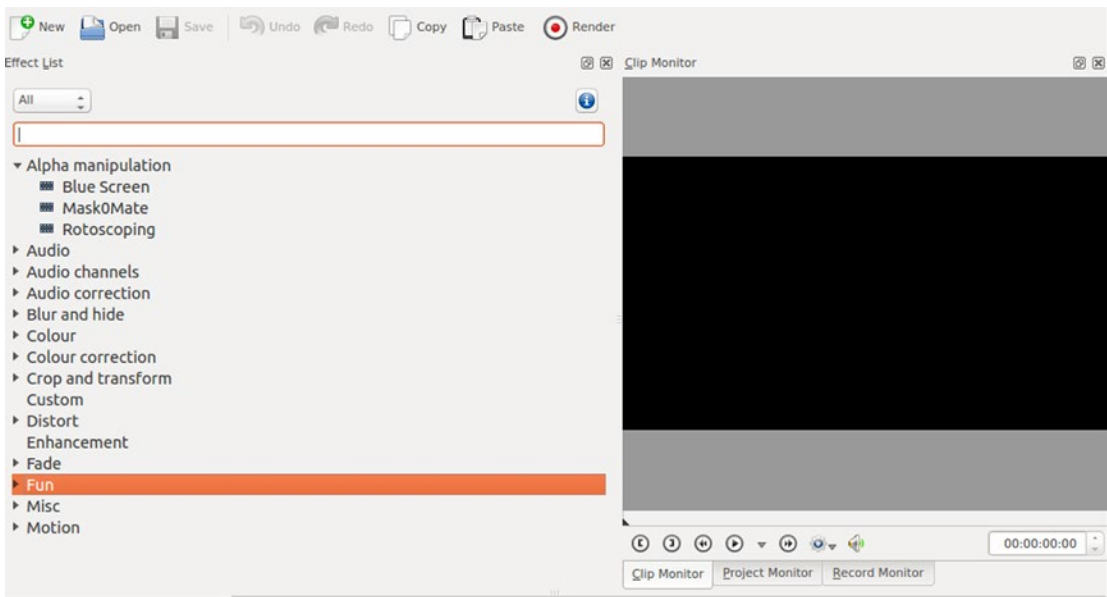

**Figure 5-19.** A video clip in the Kdenlive timeline

More often than not, the quality of the video shot with consumer camcorders and video cameras can stand improvement. The *Color Correction* effect is especially useful for polishing up video by improving colors and exposure in footage.

The *Curves* feature (Figure 5-20) helps bring out detail in dark footage. Color can be enhanced by using the *3 point balance* or the *white balance* effect.

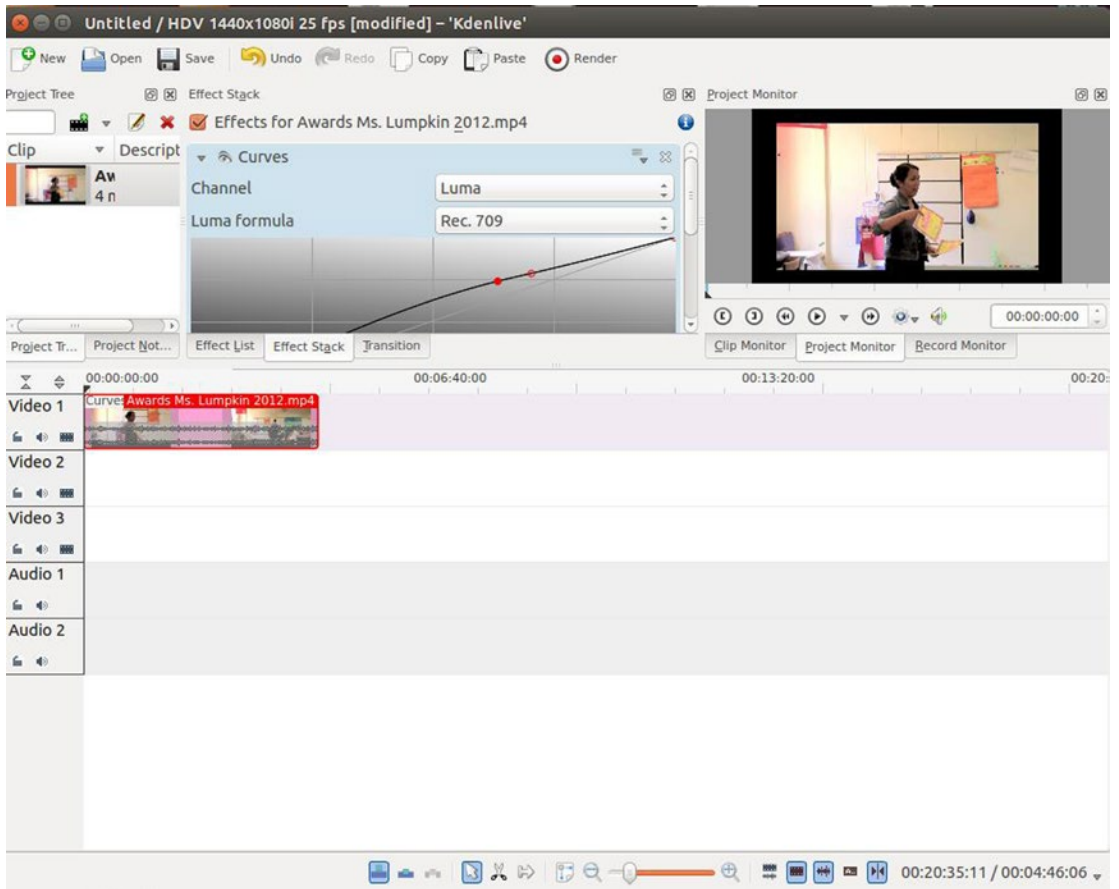

**Figure 5-20.** Detail can be brought out of dark footage using Curves

When your movie is completed, there are numerous video format choices available for output. It can be output to various formats such as MPEG-2, MPEG-4, Raw DV, just to name a few (Figure 5-21). It can also output to DVD using your computer's DVD authoring software.

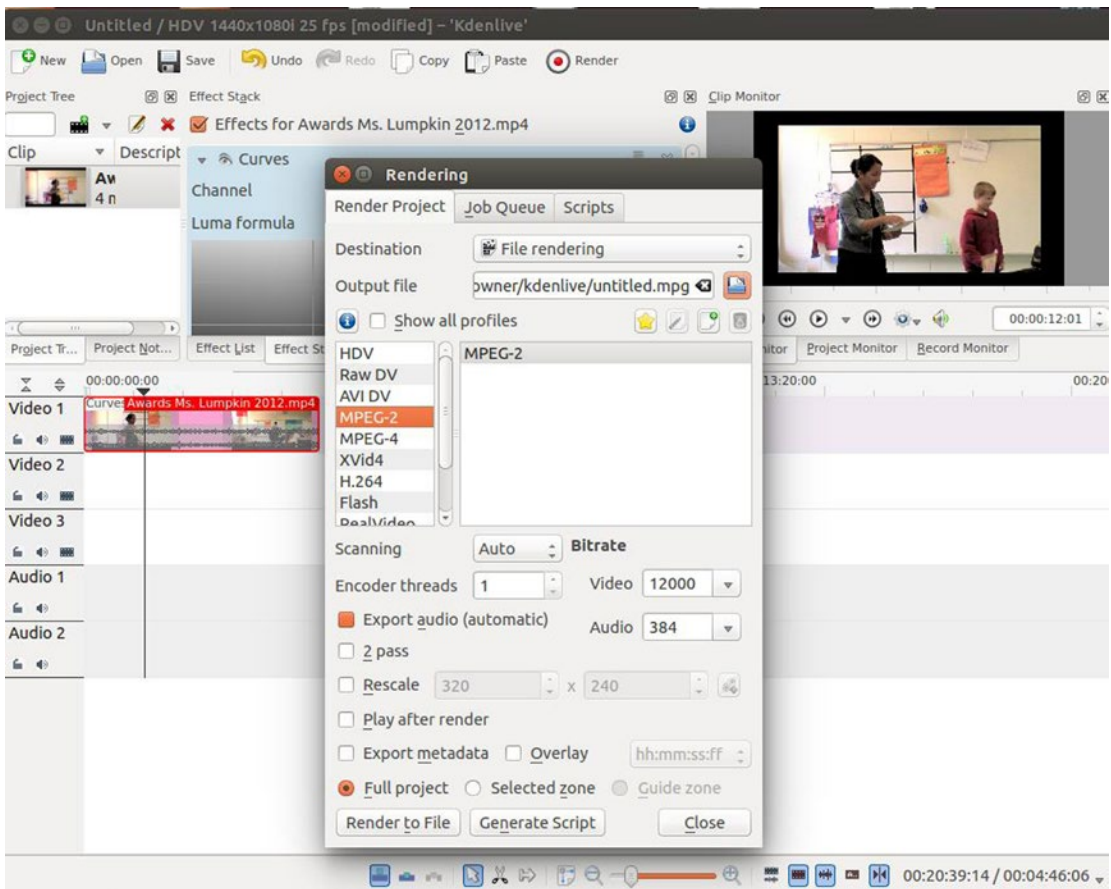

Figure 5-21. Kdenlive offers numerous video formats for output of your movie

## Kdenlive Support

The *Kdenlive/Manual* is the best place to start. It can be found on the Kde UserBase Wiki (Figure 5-22). The link to the wiki is <https://userbase.kde.org/KdenLive/Manual>. There are plenty of Kdenlive video tutorials on YouTube as well, everything from beginning tutorials to advanced editing techniques. There is also an active forum where you can ask your questions.



**Figure 5-22.** *The Kdenlive Manual*

## Summary

This chapter looked at several no-cost solutions for working with audio and video files. This can be especially useful for the small business looking to create marketing messages to get on to platforms like YouTube, social media, and other avenues where audio and video is effective.

The first software title, *fre:ac* (Free Audio Converter), is a free and effective tool for ripping CDs and converting audio files from one format to another. Audacity also converts audio files, but it also captures analog audio from sources such as audio tapes and LP records. Audacity offers effects filters and editing capabilities for audio.

MPEG Streamclip is a handy tool with rudimentary editing abilities primarily used for converting video files from one format to another. Windows Movie Maker (often already installed on Windows computers) is a free video editing program that offers a number of transitions and effects to polish up your video productions. VirtualDub is a video capture and processing application for Windows that can work well as a companion program to Movie Maker. It offers a wealth of effects filters, including color and exposure correction. Kdenlive is a feature-rich video editing program for use with Linux and Mac OS. It boasts a number of effects and transition styles. It can also edit HD video.

For additional no-cost programs, there are several other audio and video programs as well as disc burning software listed in Appendix B of this book.

In the next chapter, you'll look at some free options for project planning, inventory management, and time tracking.

## CHAPTER 6



# Project Planning, Inventory Management, and Time Tracking Software

Organization and accuracy are crucial in any business. During my early days in the retail hardware business, projects were planned on pen and paper. Inventory specialists did physical counts of the store's inventory twice a year (in those days, we were not computerized). Tracking the time invested in business activities was largely guesswork.

This chapter looks at several powerful, free options for planning projects, and keeping track of inventory, human resources, and billable time. Here's a quick look at the software programs covered in this chapter:

### **Project Management**

- **ProjectLibre:** An open source program that is compatible with but an alternative to Microsoft Project
- **Gantter:** A free web-based project management solution that can be accessed anywhere

### **Human Resources Management**

- **FreeHR:** A free program for managing human resources such as employee records and schedules

### **Inventory Management**

- **ABC Inventory:** A free, robust program for inventory management

### **Time Tracking**

- **My Hours:** A free, web-based time tracking solution ideal for solo freelancers

## ProjectLibre: An Open Source Alternative to Microsoft Project

ProjectLibre is an extremely useful program for creating and managing company projects. It's capable of everything from simple projects requiring only a few tasks to complex projects involving multiple colleagues.

**Here are a few facts about ProjectLibre at a glance:**

- **Alternative to:** Microsoft Project
- **Website:** [www.projectlibre.org](http://www.projectlibre.org)
- **License:** GNU
- **Current Version:** 1.5.9
- **Operating Systems:** Cross-platform
- **Potential Savings:** \$589.99

ProjectLibre is described on the software provider's website as the open source replacement for Microsoft Project. With the standard version of MS project costing almost \$600.00, it's certainly worth trying out.

---

■ **Note** I use ProjectLibre for planning both professional and home projects; it has become one of the most important programs I rely on. ProjectLibre is used in over 200 countries.

---

### Feature Highlights

According to the website, ProjectLibre has been downloaded over 1,700,000 times and was named Computerworld's "Best Open Source Software." Here's a quick look at the features:

- Compatibility with Microsoft Project 2010
- User interface improvement
- Gantt chart
- PERT chart
- Network diagram
- Earned value costing

ProjectLibre relies on Java to work, so you should make sure that the latest version is installed on your computer. After downloading and installing ProjectLibre, you're ready to start a new project (Figure 6-1). The project can be given a name, the name of project manager, start date (it assigns the current date by default), and any relevant notes.

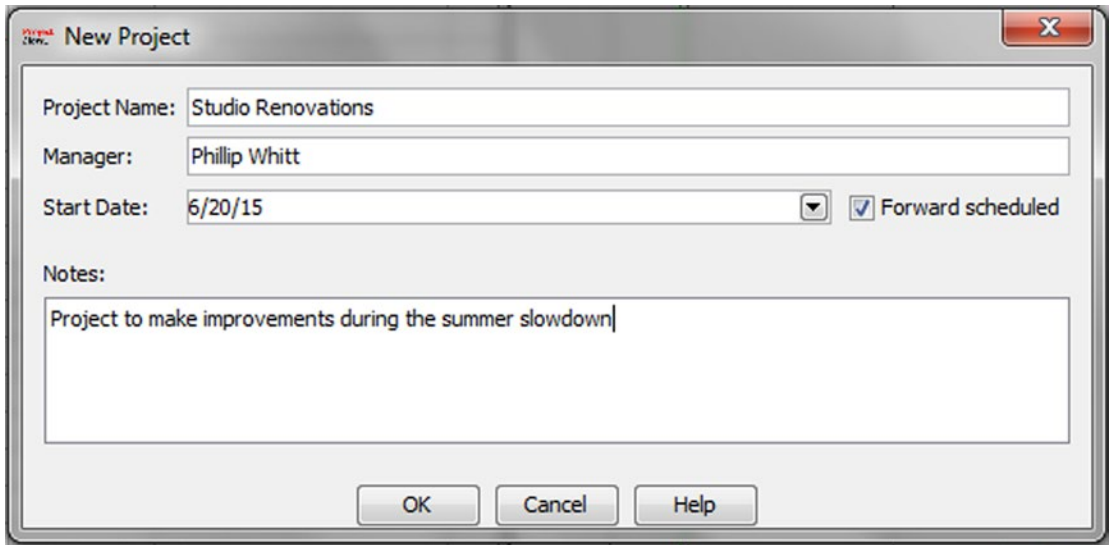

**Figure 6-1.** Starting a new project in ProjectLibre (Used with permission © Marc O'Brien 2015)

Adjustments can be made in the *Project Information* dialog box (Figure 6-2). Under the *General* tab are settings such as start and finish dates, status, the expense type, project type, etc.

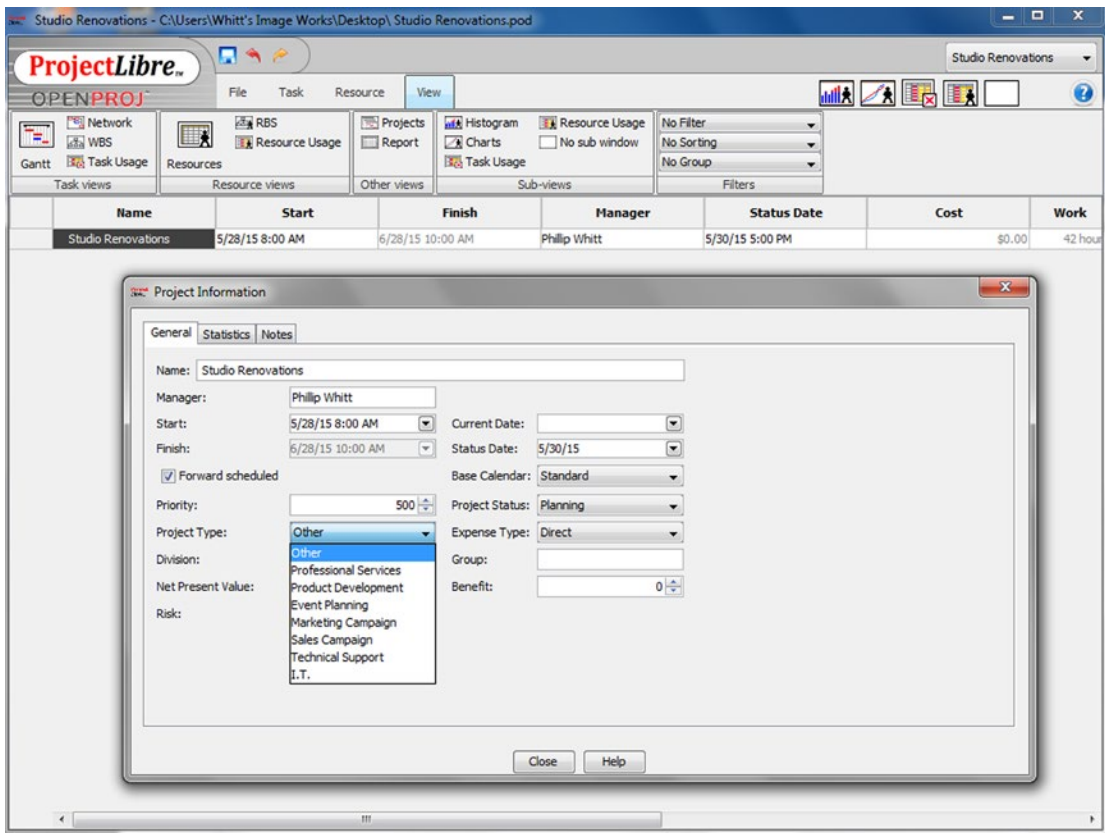

**Figure 6-2.** The Project Information dialog box (Used with permission © Marc O’Brien 2015)

The workspace shows the tasks of my project on the left as data in a spreadsheet, and on the right graphically represented as a Gantt chart (Figure 6-3). A Gantt chart is essentially a bar chart that illustrates the start/finish dates of tasks in the project.

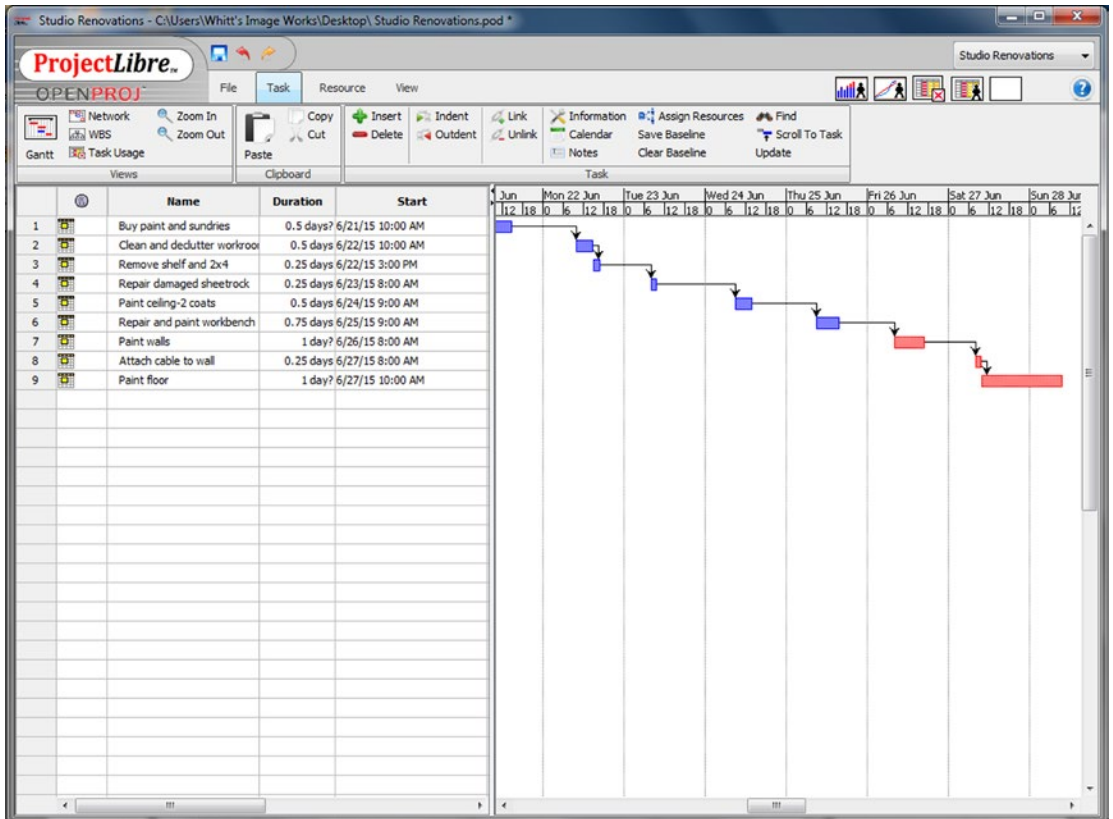
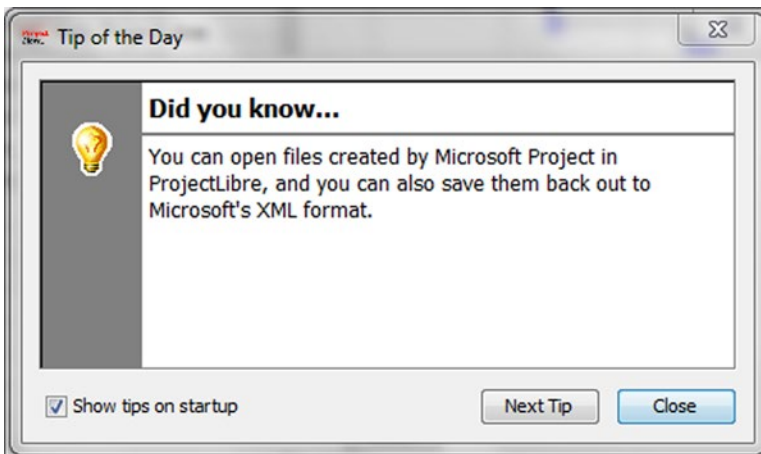

**Figure 6-3.** The Gantt chart illustrates the start and finish dates of each task in the project. (Used with permission © Marc O'Brien 2015)

■ **Note** In my sample project, the arrows shown represent the order in which the tasks must be undertaken (known as dependencies). This basically means that a specific task must be completed before I can move on to the next one. The arrows are inserted by clicking a task on the Gantt chart, and dragging a line to the sequential task in the workflow. When the mouse button is released, the arrow is created.

## ProjectLibre Support

A great way to become familiar with ProjectLibre is to open the *Help* menu and cycle through the *Tip of the Day* window (Figure 6-4). If you join the ProjectLibre Community, you'll have access to the blog posts, discussion groups, and user groups.



**Figure 6-4.** Taking some time to cycle through and read each the tip of the day will help you quickly become acquainted with ProjectLibre. (Used with permission © Marc O'Brien 2015)

There are a number of YouTube tutorials that are very helpful in learning this program. Also, there is a PDF of the *ProjectLibre User Guide* that can be downloaded from this URL: <http://adte.ca/pdf/ProjectLibre.pdf>.

## Ganttter: A Free Web-Based Project Management Solution

Ganttter is a free project scheduling tool from Smartapps.com. It's similar to ProjectLibre in most respects, but because it's a web-based application, it can be accessed from any computer connected to the Internet.

### Here are a few facts about Ganttter at a glance:

- **Alternative to:** Smartsheet
- **Website:** [www.ganttter.com](http://www.ganttter.com)
- **License:** Proprietary SAAS
- **Current Version:** 3.0
- **Operating Systems:** Web-based/Cross-platform
- **Potential Savings:** \$14.00 per month

Like MS Project or ProjectLibre, Ganttter is capable of scheduling projects both simple and complex. Because it is web-based, it appeals to those who prefer working in their browser (there is a desktop version available in the Chrome Web Store for \$9.99).

## Feature Highlights

Ganttter offers a number of useful features, making it a worthy web-based application for project management. Here's a look at a few:

- Supports over 20 languages
- Attach files and links directly from your favorite cloud storage provider

- Import and export MS Project files
- Organize your schedules better by customizing task and Gantt chart colors
- Autosave feature prevents loss of changes made
- Gantt chart
- PERT chart

Ganttter is available in four editions: one for Smartapp.com, one for Google Drive, one for Google Apps, and the paid desktop version (Figure 6-5). All Ganttter files are compatible with all editions of Ganttter.

The screenshot shows the Ganttter website's 'Ganttter Editions' page. It features a navigation bar with 'home', 'ganttter editions', 'news', and 'community'. Below the navigation, there's a section titled 'Ganttter for smartapp.com & Google. Compare and choose the one that's right for you! Regardless of which Ganttter edition you choose all Ganttter files are compatible with all editions of Ganttter.' This section includes four icons representing the editions: smartapp.com, Google Drive, Google Apps, and Desktop. Below this is a 'Capabilities' table with a 'Start Now' button for each edition. A 'chrome web store' badge is also present.

Capabilities	FOR smartapp.com	FOR Google Drive	FOR Google Apps	FOR Desktop
Use your existing Google account to log in	✓	✓	✓	✓
Manage all your files, including Ganttter project schedules from one location, anytime, anywhere	✓	✓	✓	✓
Share Ganttter project schedules with your Company's Google Apps Domain Users			✓	
Real-time editing and chat with other Google Users		✓	✓	
Community Powered Templates	✓	✓	✓	
Share Ganttter project schedules with anyone	✓	✓	✓	
Seamless Integration with File Central SmartDrive	✓			
Use your existing Facebook or LinkedIn account to log in	✓			
Import and Export MS Project files directly from Ganttter	✓	✓	✓	
Ability to work offline				✓

**Figure 6-5.** A feature comparison of the four editions of Ganttter (Used with permission © InQuest Technologies 2015)

In this example, I'm creating a sample project in which I will first design and then hire a contractor to build a display rack for selling printed digital artwork in a local gift shop. Figure 6-6 shows the settings under the *General* tab where the project is given a name and start date, and options for the calendar. The other tabs are for formatting parameters such as industry type, length of a working day, resources, etc.

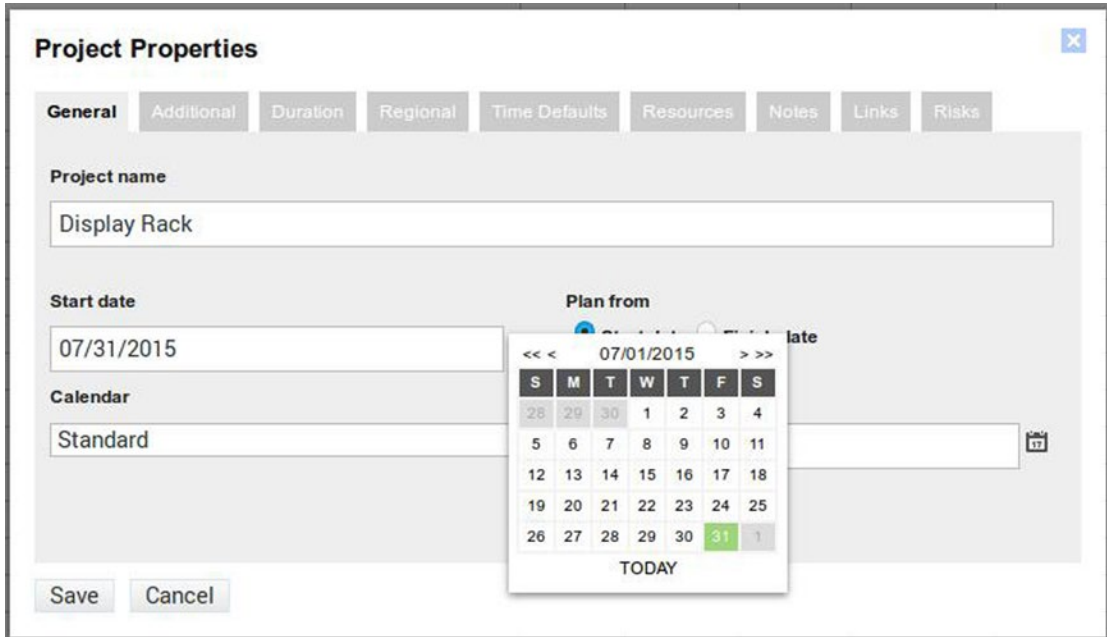

**Figure 6-6.** The Project Properties dialog (Used with permission © InQuest Technologies 2015)

The properties of the tasks that comprise the project can also be set. Like other project management software, dependencies can be put into place (Figure 6-7).

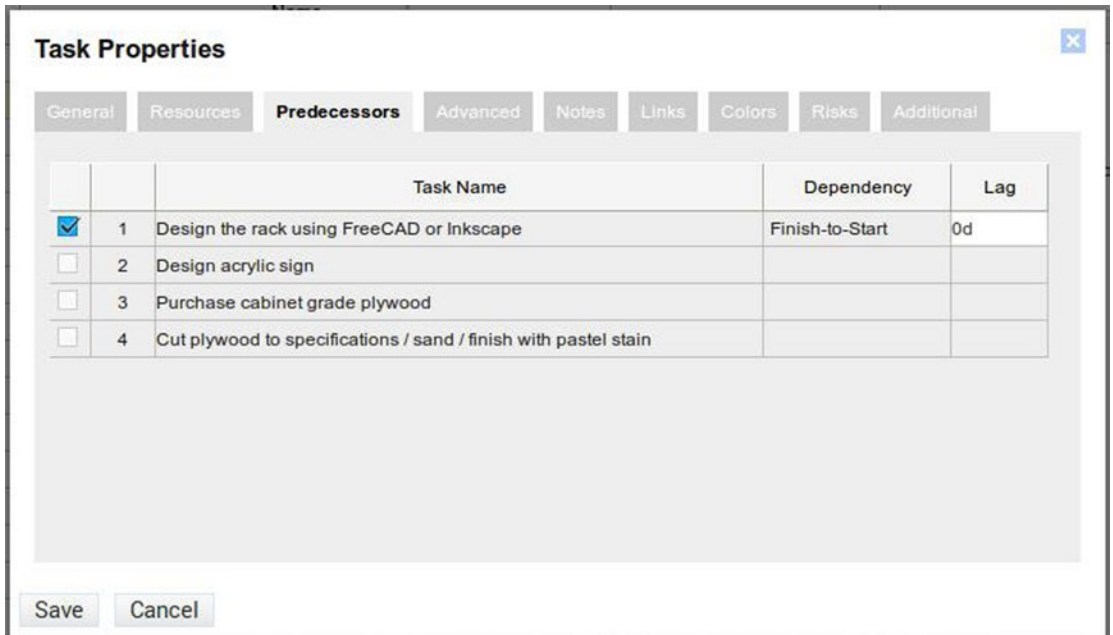

**Figure 6-7.** The Task Properties dialog (Used with permission © InQuest Technologies 2015)

In the Gantt chart view of the project created (Figure 6-8), the order in which the tasks must be completed is indicated by an arrowed line. Two of the tasks indicate that there are resources connected, which in this case is the contractor who will actually cut and finish the cabinet-grade wood, and then assemble and finish it.



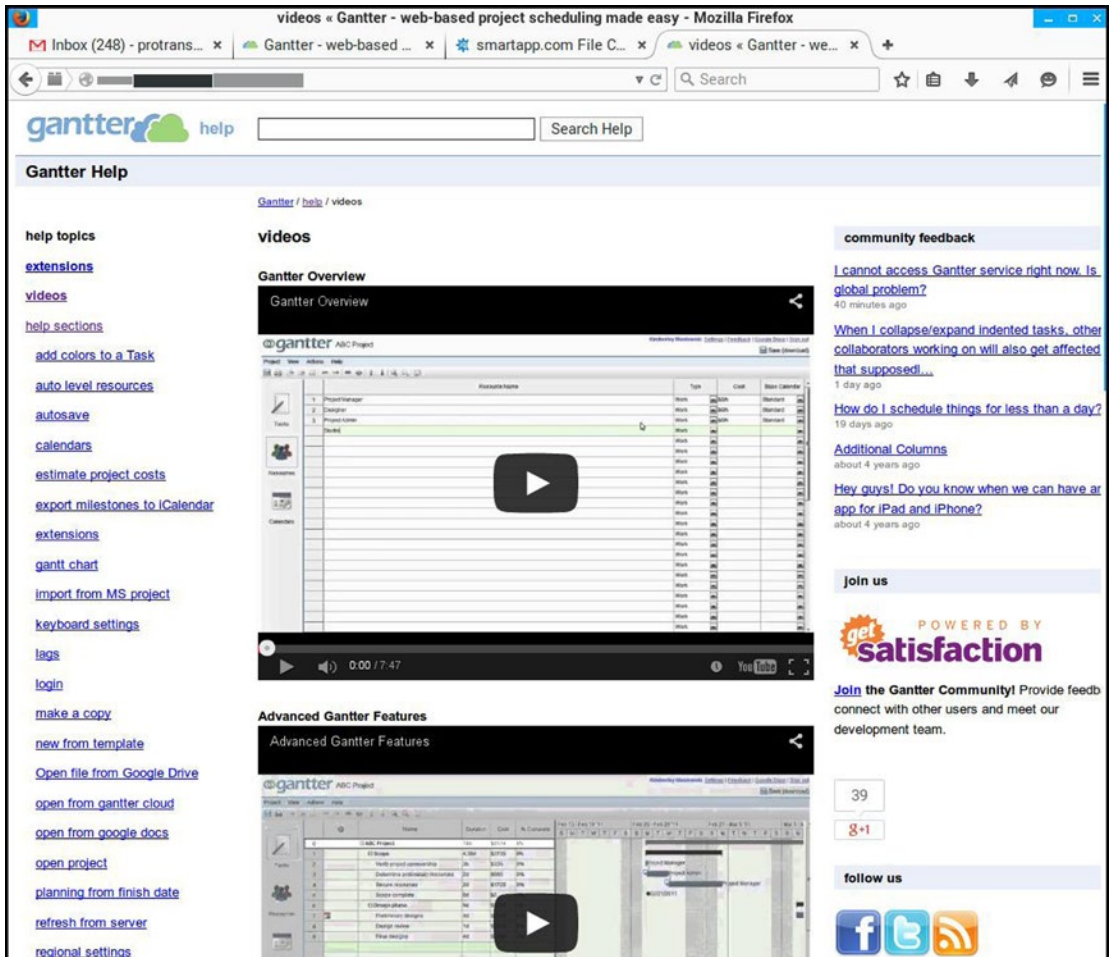

**Figure 6-9.** The Gantter Help page has lots of information and tutorial videos that are especially useful. (Used with permission © InQuest Technologies 2015)

## FreeHR: Free Web-Based Human Resource Software

FreeHR, a program from the Isys Group, is very useful for managing the aspects of company employees, such as performance evaluations, vacation schedules, and other records. Everything is stored in the cloud, so it can be accessed anywhere.

**Here are a few facts about FreeHR at a glance:**

- **Alternative to:** Zoho People
- **Website:** <http://freehr.com/>
- **License:** Proprietary SAAS
- **Current Version:** Unspecified

- **Operating Systems:** Web-based
- **Potential Savings:** \$39.00 per month

According to the FreeHR website, the core will always be free, but paid modules with advanced features are planned for the future.

## Feature Highlights

Although FreeHR doesn't include modules for payroll or recruiting, it does offer a number of features to help manage your employees' records and schedules, such as the following:

- *HR Information at a glance:* See the state of the company or employee at a glance.
- *Employee self-service:* Employees can request vacations, sick days, and absence online.
- *Messaging alerts:* Receive notification when action is required from you.
- *HR charts and graphs*
- *Role-based security:* Choose what information employees and managers can access.
- *Documents:* Save time and paper by using FreeHR to manage employee documents online.
- *Powerful Reporting:* FreeHR includes 20 standard reports such as employee list, length of service, pending requests, etc.

An employee record can include basic information such as the employee's name, job title, employee number, photo, phone number(s), e-mail, start date, probation period, etc. (Figure 6-10).

Employees | Calendar | Clocking Manager | Anomalies | Stats | print

Overview

Employee #

Title \*

First Name \*

Middle Name

Last Name \*

Known As

Mobile Tel

Work Tel

  
Change Photo

User Details

Email \*  User  An email will be sent

Permissions  Super User

Personal Details

Job Details

Job Title  Rota

Start Date \*  Grade

End of Probation  Location

Leave Date  Cost Centre

Reports To

Group Membership

Remuneration

Reload Edit Save top

**Figure 6-10.** Setting up an employee record (Used with permission © Isys Group 2015)

You can be notified of certain events, such as anomalies in an employee's time and work. It will track frequency of tardiness, time left early, insufficient work for shift, etc. (Figure 6-11).

## Event Notifications

Notification times Weekly Monday 00:00 Daily 00:00

---

### Anomalies

Name	Display	Send Email	Send Message	Frequency
Late	<input checked="" type="checkbox"/>	<input type="checkbox"/>	<input type="checkbox"/>	Daily
Left Early	<input checked="" type="checkbox"/>	<input type="checkbox"/>	<input type="checkbox"/>	Daily
Not Enough Work For Shift	<input checked="" type="checkbox"/>	<input type="checkbox"/>	<input type="checkbox"/>	Daily
Not Enough Break For Shift	<input checked="" type="checkbox"/>	<input type="checkbox"/>	<input type="checkbox"/>	Daily
Work Activity Open	<input checked="" type="checkbox"/>	<input type="checkbox"/>	<input type="checkbox"/>	Daily
Break Activity Open	<input checked="" type="checkbox"/>	<input type="checkbox"/>	<input type="checkbox"/>	Daily
Work Not Contracted	<input checked="" type="checkbox"/>	<input type="checkbox"/>	<input type="checkbox"/>	Daily
Flexible Hours Too Low	<input checked="" type="checkbox"/>	<input type="checkbox"/>	<input type="checkbox"/>	Daily
Invalid Action	<input checked="" type="checkbox"/>	<input type="checkbox"/>	<input type="checkbox"/>	Daily
No Work For Shift	<input checked="" type="checkbox"/>	<input type="checkbox"/>	<input type="checkbox"/>	Daily

**Figure 6-11.** You can be notified of anomalies such as employee tardiness, incomplete work, etc. (Used with permission © Isys Group 2015)

Performance booking allows you to schedule and detail performance reviews (Figure 6-12). There are options for Company Review, Team Review, Induction, 3 Month Review, or Add New.

The screenshot displays a web-based interface for 'Performance Booking'. At the top, there is a navigation bar with user information (Phillip Whitt) and tabs for 'Myself', 'Everyone', 'My Tasks', and 'Reports'. Below this is a secondary navigation bar with options like 'Employees', 'Calendar', 'Clocking Manager', 'Anomalies', and 'Stats'. The left sidebar lists various booking categories, with 'Performance Booking' currently selected. The main content area is divided into several sections:
 

- Performance Event Details:** A form with fields for Meeting (01/Sep/2015 00:00), Reason (Promotion), Review Date (01/Sep/2015), Type (3 Month Review), Location, and Expiry Date (31/Dec/2015).
- Attendees:** A table with columns for Name and Notes. One entry shows 'John Smith' with the note 'with John and discuss excellent performance and promotion to department manager'.
- Follow Up:** A table with columns for Type, Assigned To (Search for employee), Due Date (06/06/2015), and Notes.
- Notes:** A table with columns for Type and Notes.

 Each section has a '+' icon to add new entries and an 'x' icon to delete existing ones.

**Figure 6-12.** Performance Booking records performance reviews for employees, teams, and the company. (Used with permission © Isys Group 2015)

There are also booking events for addressing areas such as discipline, grievances, training, vacations/holidays, sick days, and leave of absence.

## FreeHR Support

You'll probably get many (if not most) of your questions answered on the FAQ page (Figure 6-13). However, there are paid support packages available at various rates, depending on your needs.

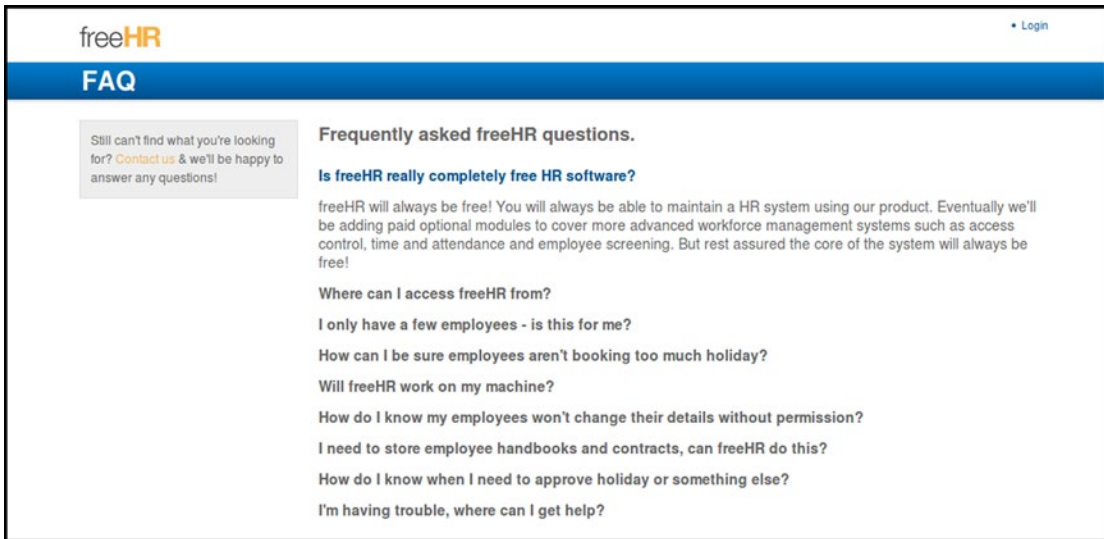

**Figure 6-13.** The FAQ page provides basic information about FreeHR. (Used with permission © Isys Group 2015)

Although there aren't very many at this writing, a few overview videos can be found on YouTube.

## ABC (Always Better Control) Inventory: A Free Option For the Small- and Mid-Sized Business

ABC Inventory from Almyta Systems is a free inventory management program for Windows. It might be just the solution for a budget-minded small warehouse or distribution center.

**Here are a few facts about ABC Inventory at a glance:**

- **Alternative to:** InFlow
- **Website:** [www.almyta.com/abc\\_inventory\\_software.asp](http://www.almyta.com/abc_inventory_software.asp)
- **License:** Proprietary Freeware
- **Current Version:** 3.0
- **Operating Systems:** Windows
- **Potential Savings:** \$14.00 per month

ABC Inventory can be installed on as many workstations as you wish, but you won't be able to link them together to read and write the same information (an upgrade to the paid version is required). Of course, if managing inventory is handled from a single workstation, this won't be an issue.

## Feature Highlights

ABC Inventory is a robust program. As you can see, it has a long list of features making it a worthy program to try:

- Single user (multi-user available in the commercial version only)
- Multiple companies
- Multiple Warehouses for a company
- Multiple currencies/currency rates auto-update
- User-selectable decimal places for currency
- Multiple logos
- User-selectable decimal places for inventory units
- Password protection
- Screen and report permissions by user or group
- Screens and reports customizations
- Export data to Microsoft Excel, Word, HTML, and text functionality
- Copy to New company function/Company backups
- Restore Last function/Restore Any function

After installing ABC Inventory, it's a good idea to open the sample *XYZ, Corp. entry* to learn your way around the program, as it's rather complex. When you're ready, you can create a real company with clean data (Figure 6-14). To create a new test, choose *New Company with Test Data*. You can also link to an existing networked company.

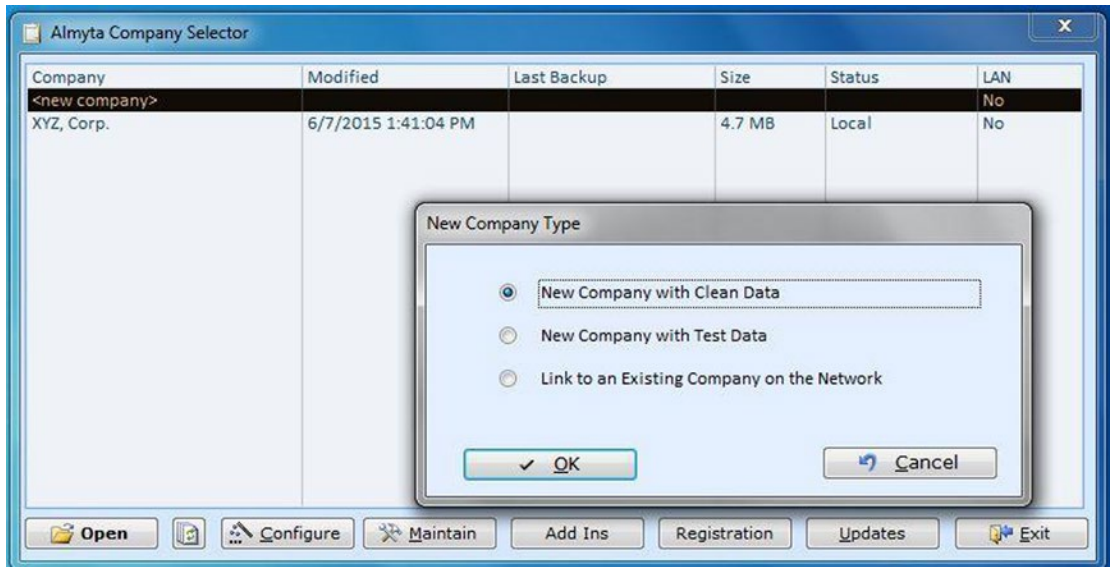

**Figure 6-14.** The New Company Type option window (Used with permission © Almyta Systems 2015)

New items can be added to the Inventory Item Master List. Parameters such as category, package type, manufacturer/model, and other pertinent information can be input (Figure 6-15).

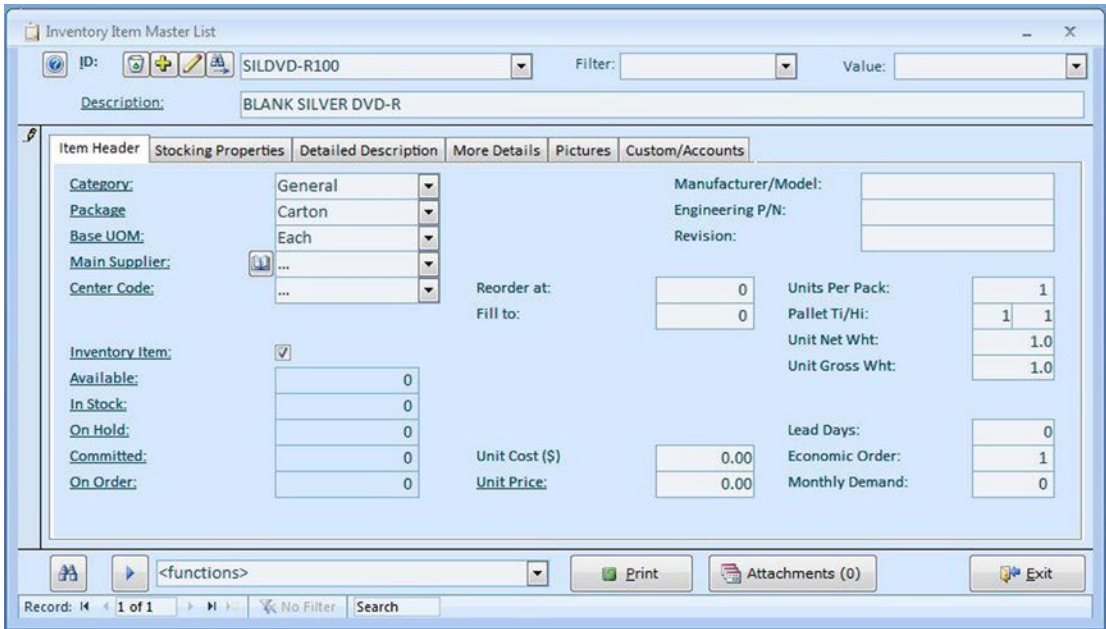

**Figure 6-15.** Adding a new item to the Inventory Item master List (Used with permission © Almyta Systems 2015)

New items can be added to the Inventory Item Master List. Parameters such as category, package type, manufacturer/model, and other pertinent information can be input (Figure 6-16).

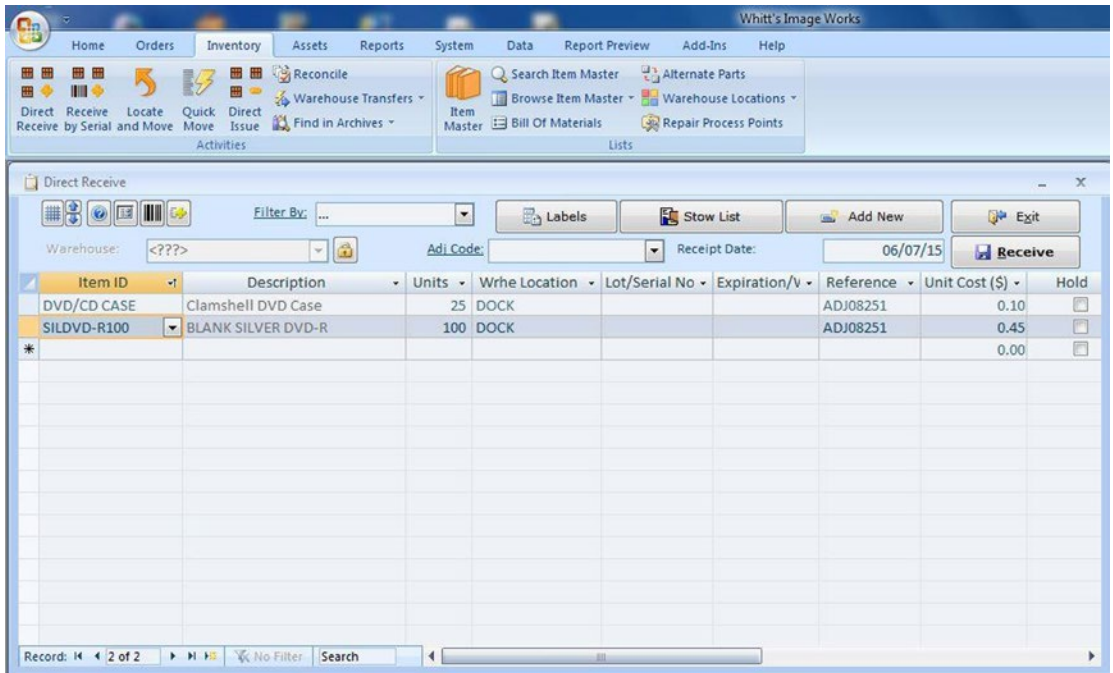

**Figure 6-16.** The inventory master list (Used with permission © Almyta Systems 2015)

## ABC Inventory Support

The *Help* tab offers a tutorial on navigating through the menus (Figure 6-17). Although support is not offered for the free version of ABC Inventory, there are one or two video overviews on YouTube. The software documentation can be accessed from this URL: [www.almyta.com/v3/](http://www.almyta.com/v3/).

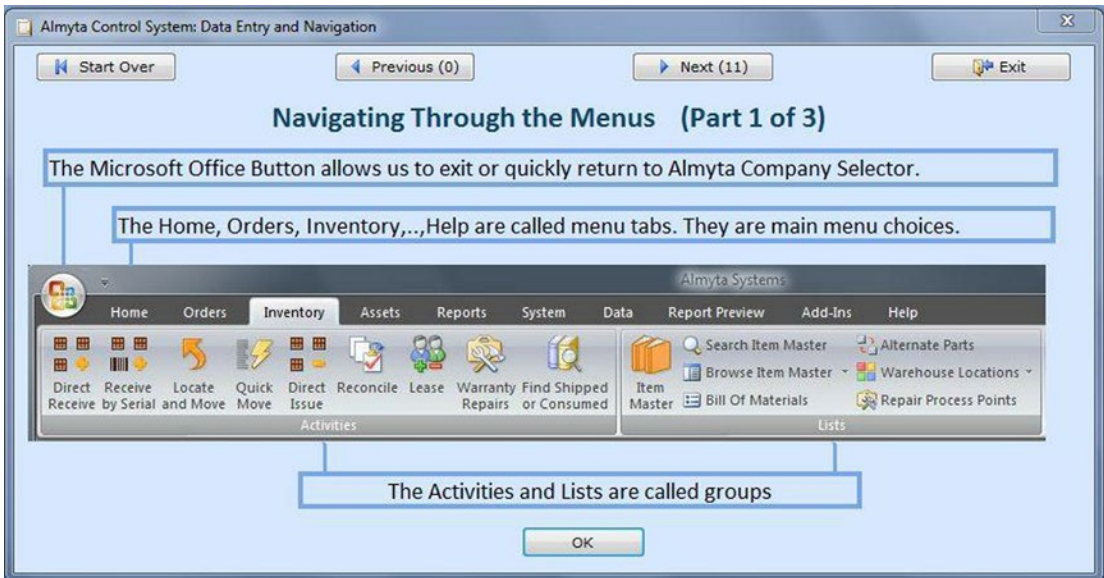

**Figure 6-17.** A tutorial on navigating the menus (Used with permission © Almyta Systems 2015)

## My Hours: A Free, Web-Based Time Tracking Tool for the Solo Freelancer

The importance of keeping track of billable time spent working on client projects can't be understated. It's amazing how much billable time can be lost if it's not tracked correctly. My Hours is an easy-to-use, web-based program that any freelancer should try.

### Here are a few facts about My Hours at a glance:

- **Alternative to:** Bill4Time
- **Website:** [www.myhours.com](http://www.myhours.com)
- **License:** Proprietary Freeware
- **Current Version:** Not Specified
- **Operating Systems:** Web-based
- **Potential Savings:** \$30.00 per month

My Hours is free for solo users, and for teams is a bargain at only \$2.00 per month for each user. Since it's web-based it can be accessed anywhere, making it a very useful and convenient solution for tracking time.

## Feature Highlights

My Hours has a number of features to help you manage billable time efficiently:

- Start and stop the timer with a single click. Stop to work on other projects, take breaks, etc. and then resume when you're ready.
- Your time sheets will always be up to date.
- Set up your clients, projects, tasks, and hourly rates with ease.
- Export your report to Excel or CSV format, print it, or e-mail it.

The Manage Client function allows you to set up the client (or company) name, contact person, e-mail, phone number, and address (Figure 6-18).

The screenshot shows the 'Manage Client' interface in the My Hours application. The top navigation bar includes 'TRACK', 'ACTIVITY', 'DASHBOARD', 'MANAGE', and 'HELP'. The user is logged in as 'PHILLIP WHITT' and has a 'Sign out' button. Below the navigation, there are tabs for 'PROJECTS', 'TASKS', 'PEOPLE', 'CLIENTS', and 'PROFILE'. The 'CLIENTS' tab is active, and the 'Manage Client' form is displayed. The form contains the following fields:

- NAME:** Bright Images
- CONTACT PERSON:** Yvonne Williams
- EMAIL:** yvonne@brightimagesmedia.com
- PHONE:** 434-846-8273
- ADDRESS:** 3022 Memorial Ave. Lynchburg, VA 24501 (highlighted with a green border)

At the bottom of the form, there are two buttons: 'Cancel' and 'Save'.

**Figure 6-18.** Set up new clients easily using the Manage Client function. (Used with permission © My Hours (Spica International) 2015)

The Manage Project function allows you to set up the name of the project, the client's name, indicate if the project is billable, the hourly rate, and any additional notes (Figure 6-19). The time log of each project can be edited, such as setting the duration of the project.

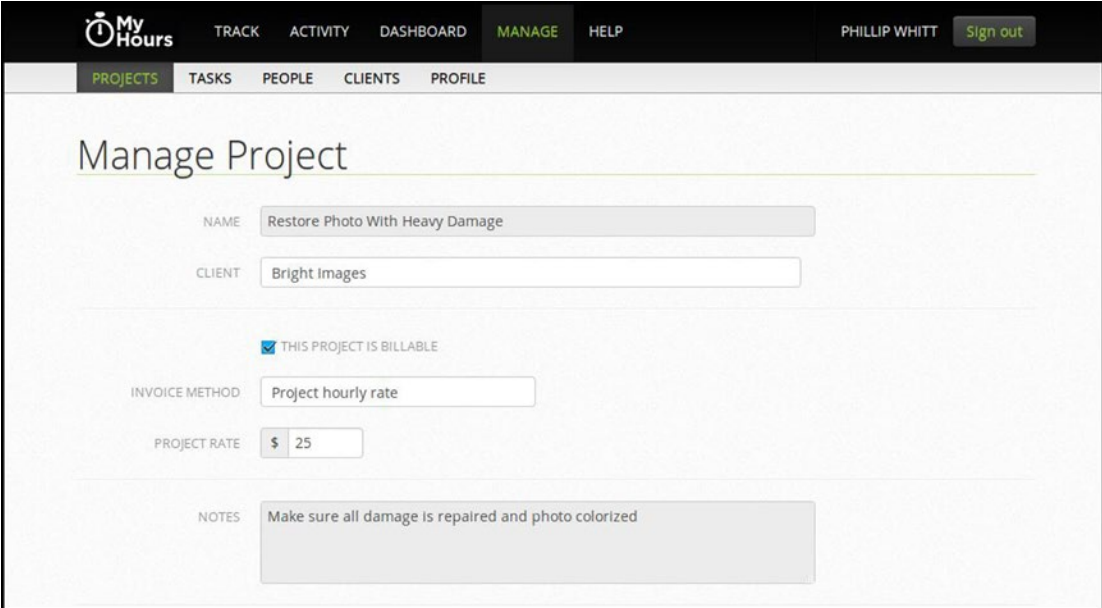

The screenshot shows the 'Manage Project' interface in the My Hours application. The top navigation bar includes 'TRACK', 'ACTIVITY', 'DASHBOARD', 'MANAGE' (highlighted), and 'HELP'. The user is logged in as 'PHILLIP WHITT' with a 'Sign out' button. Below the navigation, there are tabs for 'PROJECTS', 'TASKS', 'PEOPLE', 'CLIENTS', and 'PROFILE'. The main content area is titled 'Manage Project' and contains the following form fields:

- NAME:** Restore Photo With Heavy Damage
- CLIENT:** Bright Images
- THIS PROJECT IS BILLABLE:**
- INVOICE METHOD:** Project hourly rate
- PROJECT RATE:** \$ 25
- NOTES:** Make sure all damage is repaired and photo colorized

**Figure 6-19.** Setting up a new project (Used with permission © My Hours (Spica International) 2015)

When working on a project, just click the *Start* button to start the counter (Figure 6-20) to track the billable time. You can stop the counter when you need to work on another project, take a break, etc. When you're ready to resume, just start the counter again.

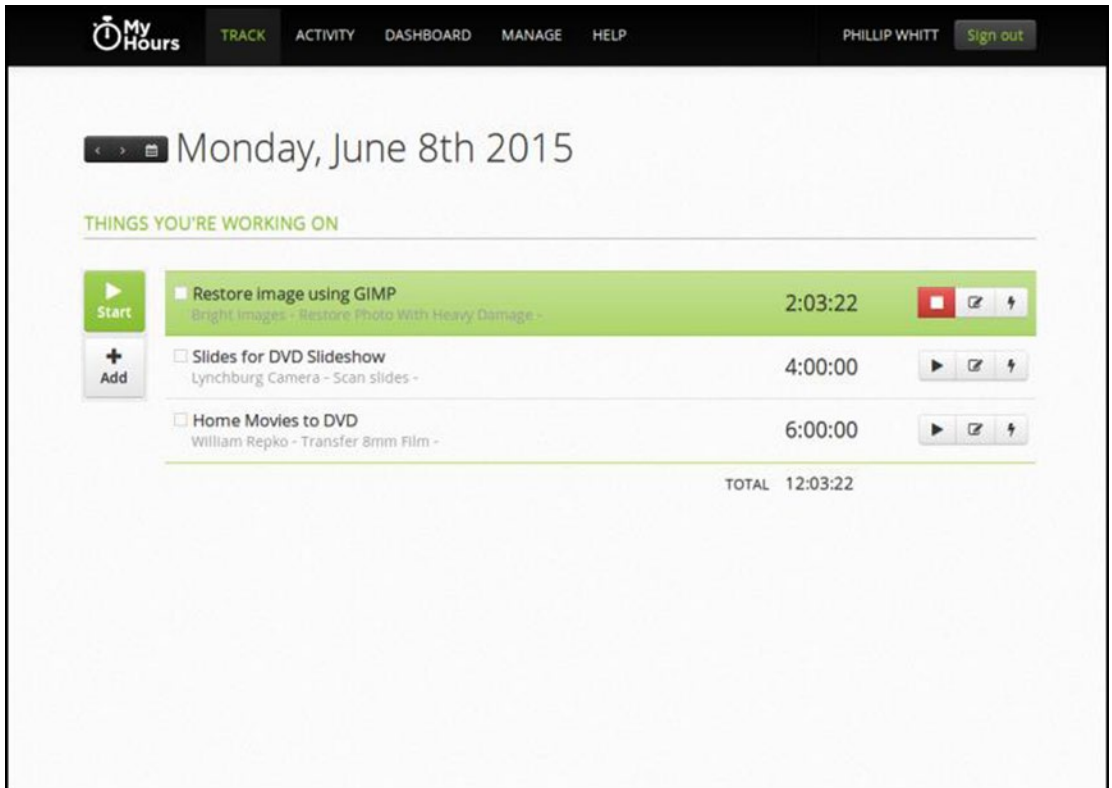

**Figure 6-20.** Start the counter when working on a project. (Used with permission © My Hours (Spica International) 2015)

The dashboard (Figure 6-21) shows you at a glance an overview of the billable time of each project, the percentage of billable time of each client, task, etc. Reports can be output as an Excel or CSV format, printed, or e-mailed.

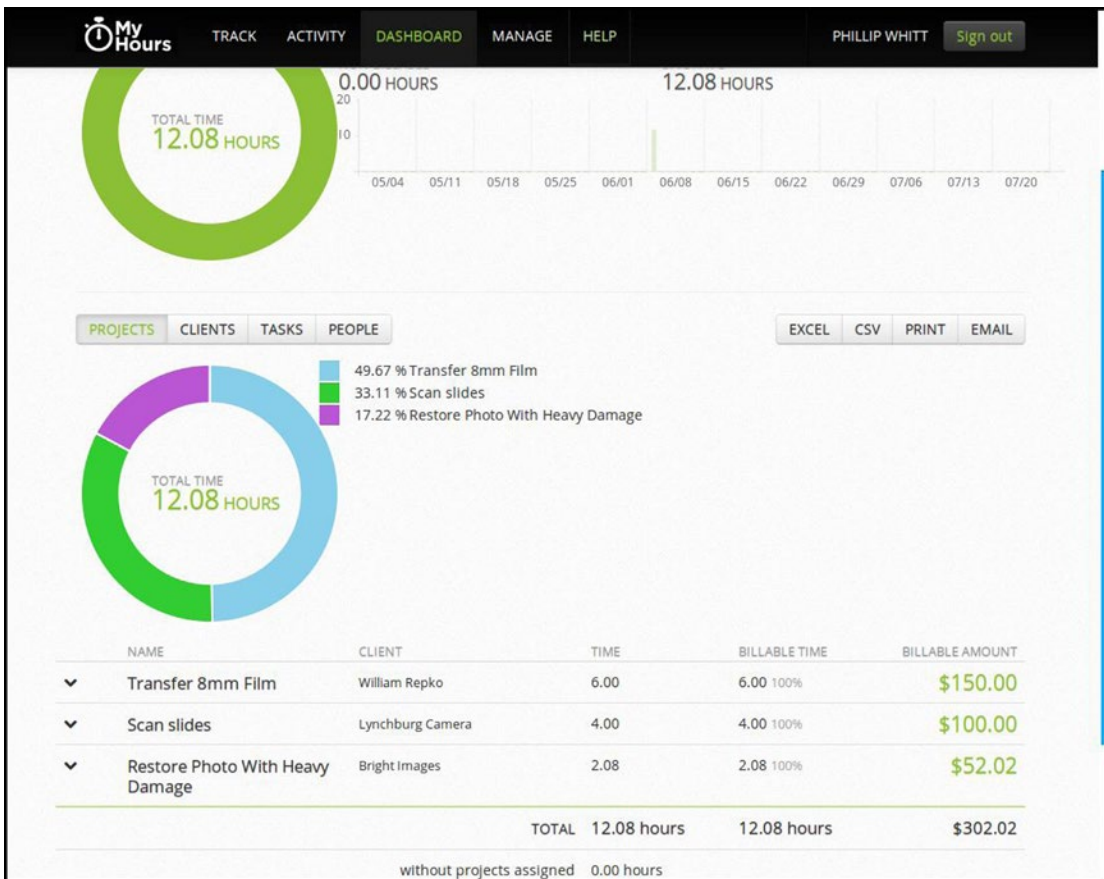

**Figure 6-21.** The dashboard provides an overview of information at a glance. (Used with permission © My Hours (Spica International) 2015)

## My Hours Support

My Hours is very easy to use; just navigate to the *Getting started* tutorial under *Resources* ([www.myhours.com/resources/gettingstarted](http://www.myhours.com/resources/gettingstarted)), as shown in Figure 6-22. The My Hours team can be contacted by e-mail at [support@myhours.com](mailto:support@myhours.com).

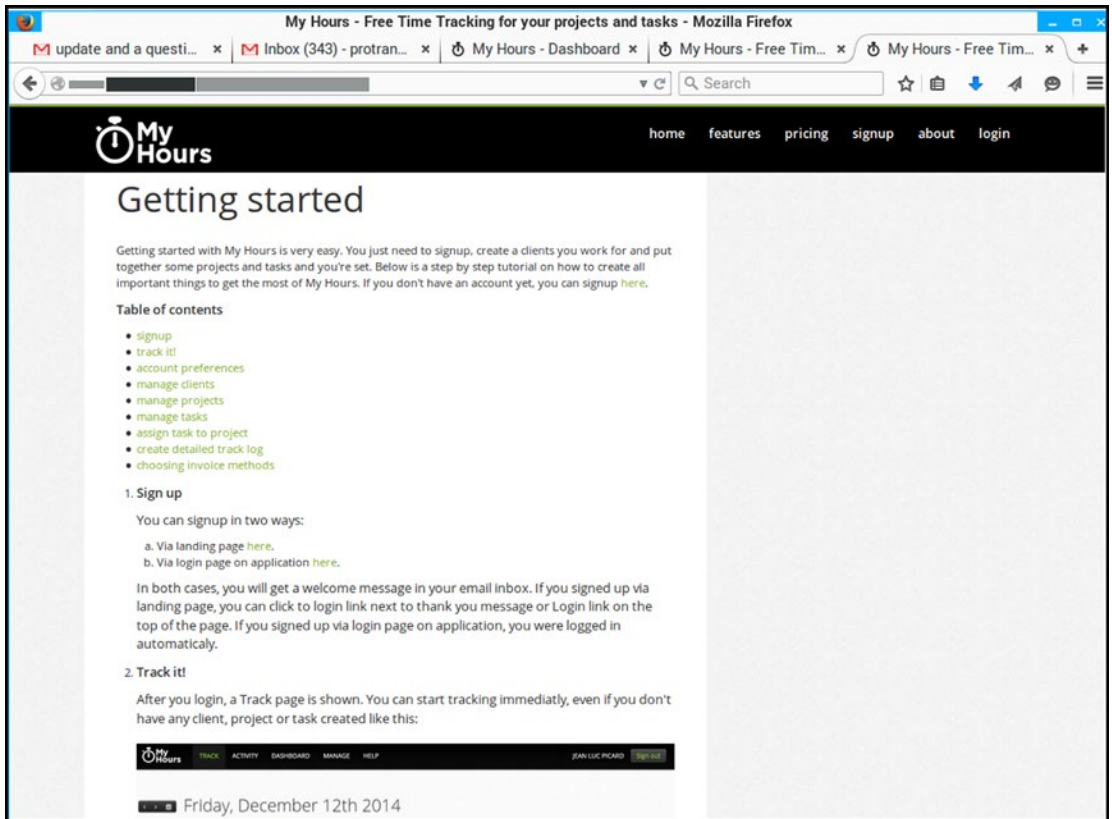

**Figure 6-22.** The Getting Started tutorial will help make using My Hours easy. (Used with permission © My Hours (Spica International) 2015)

## Summary

This chapter looked at two no-cost project management solutions. ProjectLibre is an open source, cross-platform program. Ganttter works like ProjectLibre in many respects, but is web-based and can be accessed anywhere.

Next, you looked at FreeHR, a free human resource solution for managing employee records, vacation schedules, sick leave, and other aspects of human resource management. The next item you looked at was ABC Inventory, a free (and complex but capable) program for managing inventory; this program can be a great option for a warehouse or distribution center. Finally, you explored a free, web-based solution for tracking time, an indispensable solution for solo freelancers who need to keep track of every billable hour.

In the next chapter, you'll look at several free solutions for creating websites, as well as web browsers.

## CHAPTER 7



# Website Creation Software and Web Browsers

This chapter introduces several no-cost tools for creating websites, blogging, and managing social media in order to maximize business exposure.

Here's a look at the software programs covered in this chapter:

- **WordPress:** An easy-to-use tool for website and blog creation
- **KompoZer:** An open source Dreamweaver alternative
- **BlueGriffon:** The next generation web editor
- **Chromium:** Where Google Chrome gets its code
- **Firefox:** The open source browser that respects privacy

## WordPress: Free, Open-Source Tool and Content Management System

WordPress is a CMS (content management system) that is based on PHP and MySQL, with one of its features being a plug-in architecture as a template system. As of January 2015, this program was used by more than 23% of the top 10 million websites, making it the most popular blogging system in use on the Web.

**Here are a few facts about WordPress at a glance:**

- **Alternative to:** IM Creator
- **Website:** [www.wordpress.org](http://www.wordpress.org)
- **License:** GNU GPL v2+ <sup>[4]</sup>
- **Current Version:** 4.2.2
- **Operating Systems:** PHP

WordPress is a free blogging software that can be installed onto a website so that anyone can write and manage their own blog. In general, it is easy to install and use (Figure 7-1). You start with an e-mail address, user name, password, and a blog address. The available tutorials take you concisely through all the necessary steps of installing and using your own WordPress blog. This allows you to configure and customize it, only modifying it so that it is search-engine friendly. In a nutshell, WordPress has a web template system that uses a template processor.

The image shows a registration form with four main sections:
 

- E-MAIL ADDRESS:** A text input field with a vertical cursor on the left.
- USERNAME:** A text input field.
- PASSWORD:** A text input field with a "Show" button (an eye icon) to its right.
- BLOG ADDRESS:** A text input field with a blue highlight at the end.

**Figure 7-1.** Getting started on WordPress is an easy process

## Feature Highlights

The free version of WordPress has several interesting and innovative features:

- Using its web service, Akismet checks your comments to see if they look like spam or not.
- WordPress comes with extended plug-ins so as to expand the functionality of the program: 38,217 plug-ins with nearly 1 million total downloads are included.
- BuddyPress is an integral part of WordPress; it enables you to run any kind of social network on your program, with activity streams, user groups, member profiles, messaging, and much more.
- WP Super Cache is WordPress' extremely fast caching engine that produces static HTML files.
- Jetpack by WordPress.com makes your WordPress streamlined for ease of use.
- bb press is a forum software made the WordPress way.
- Theme check is a simple, easy way to test out your theme to confirm that you are following all of the latest WordPress standards and practices. It's a terrific theme development tool.

WordPress users may choose to install and switch between themes (Figure 7-2). Themes are what allow users to change the look and functionality of a WordPress website. They can be installed without altering the content or health of the site. WordPress websites all require at least one theme be present. WordPress themes are, in general, free themes, but the program also provides premium themes a price. Users of this program may also create and develop custom themes if they have the knowledge and skill to do so.



**Figure 7-2.** There are a number of themes available in WordPress

Other features available within WordPress consist of integrated link management; a search engine-friendly, clean perm link structure; and the ability to tag posts and articles. Automatic filters are also included, providing standardized formatting and styling of text and articles. WordPress also supports the TrackBack and Pingback standards for displaying links to other sites that have themselves linked to a post or an article. WordPress blog posts can be edited in either HTML, using the visual editor, or via a number of plug-ins that offer a wide variety of customized editing features.

## Multi-User and Multi-Blogging

Before Version 3, WordPress supported one blog per installation. This was limiting, to say the least, although multiple concurrent copies were able to run from different directories, as long as they were configured to use separate database tables. WordPress Multi-User (formerly referred to as WordPress MU, or WPMU,) was almost a splitting in half of WordPress, and was created to allow multiple blogs to exist within that one installation but with the ability to be administered by a centralized maintainer. WordPress MU has made it possible for those individuals with websites to host their own blogging communities, and to also control and moderate all blogs from a single dashboard. What is even more exciting is that WordPress MS adds a new data table for each blog.

## WordPress Support

Customer support for WordPress comes in several fashions, including live chat support, a help page, e-mail support, and customer service online support. Because WordPress is a popular application, there are plenty of tutorial videos on YouTube.

## KompoZer for Easy Web Authoring

KompoZer is a complete web authoring system that combines web file management and easy-to-use WYSIWYG webpage editing. If you want to enhance business exposure with a compelling website (and Adobe Dreamweaver is a little rich for your budget), then KompoZer is worth checking out.

**Here are a few facts about KompoZer at a glance:**

- **Alternative To:** Adobe Dreamweaver
- **Website:** [www.kompozer.net](http://www.kompozer.net)
- **Current Version:** 0.7b3
- **License:** MPL/GPL/LGPL tri-license
- **Platform:** Cross-platform
- **Potential Savings:** \$19.99 per month

Designed to be extremely easy to use, KompoZer is ideal for non-technical computer users who want to create a professional looking, attractive website, without learning HTML or web coding. KompoZer is a free and open source software. Figure 7-3 shows the KompoZer home page.



**Figure 7-3.** The KompoZer home page (With permission © KompoZer Development Team 2015)

## Feature Highlights

KompoZer has an impressive list of desirable features. This is the list as shown on the website:

- WYSIWYG editing of pages, making web creation as easy as typing a letter with your word processor.
- Integrated file management via FTP. Simply log in to your web site and navigate through your files, editing web pages on the fly directly from your site.
- Reliable HTML code creation that will work with all of today's most popular browsers.
- Jump between WYSIWYG Editing Mode and HTML using tabs.
- Tabbed editing makes working on multiple pages a snap.
- Powerful support for forms, tables, and templates.
- The easiest-to-use, most powerful web authoring system available for desktop Linux, Microsoft Windows, and Apple Macintosh users.

For Linux users, KompoZer is a GTK application. It has nothing to do with KDE, although it can be installed on to KDE. (FYI, Komodo and the Kernel are not KDE applications either.)

Another thing to note is that KompoZer version 0.7.10 is NOT compatible with GTK  $\geq$  2.14; this has caused crashes on Linux distros, such as Ubuntu 8.10 and Ubuntu 9.04. To avoid this problem, make sure to download KompoZer 0.8.

There are several add-ons available to improve the functionality of KompoZer (Figure 7-4). KompoZer is considered a worthy alternative to Adobe Dreamweaver. Another quality that makes it so attractive is that it is compatible with Windows, Mac, Linux, and BSD.

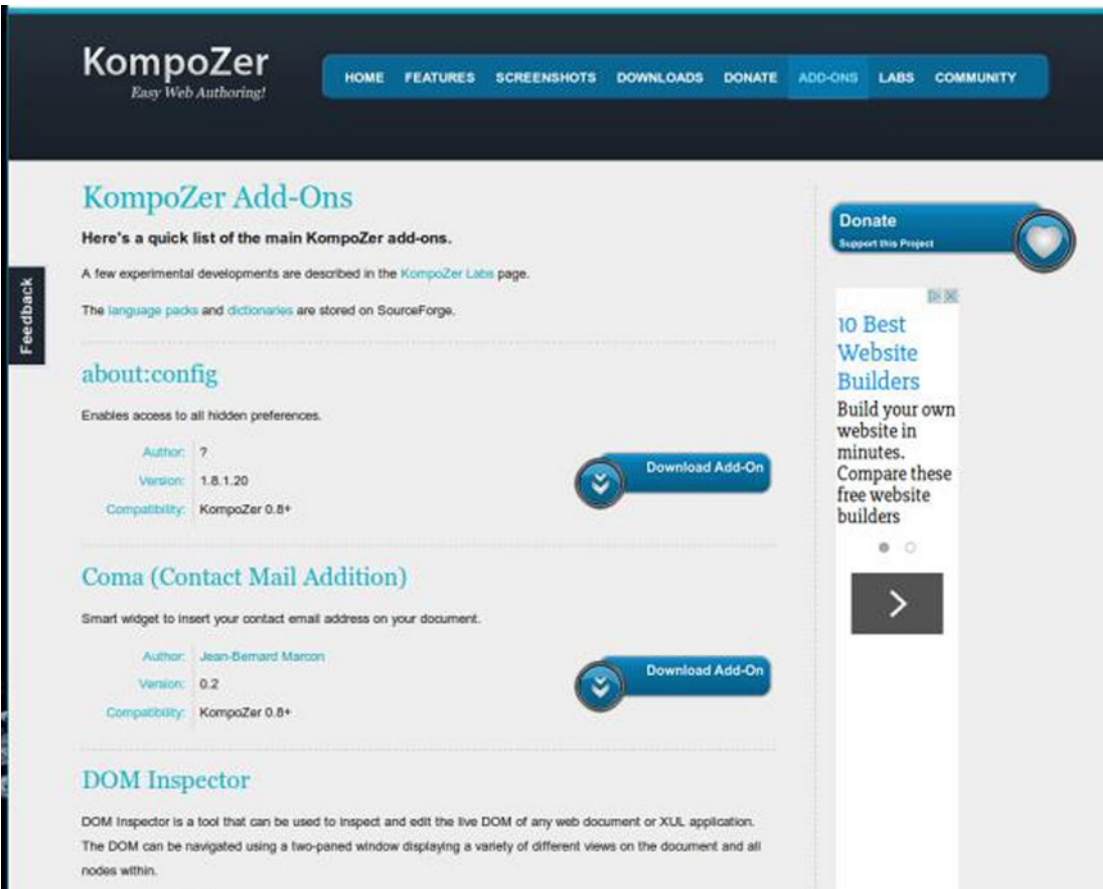

**Figure 7-4.** Add-ons are available to improve functionality. (With permission © KompoZer Development Team 2015)

## KompoZer Support

When assistance is needed, it can be found on the *Get Help/User Support* page (Figure 7-5). Additionally, a PDF User Guide can be downloaded from <http://ms.rfes.ntpc.edu.tw/~contact/kompoZer/userguide02.pdf>. There are also quite a few video tutorials on YouTube.

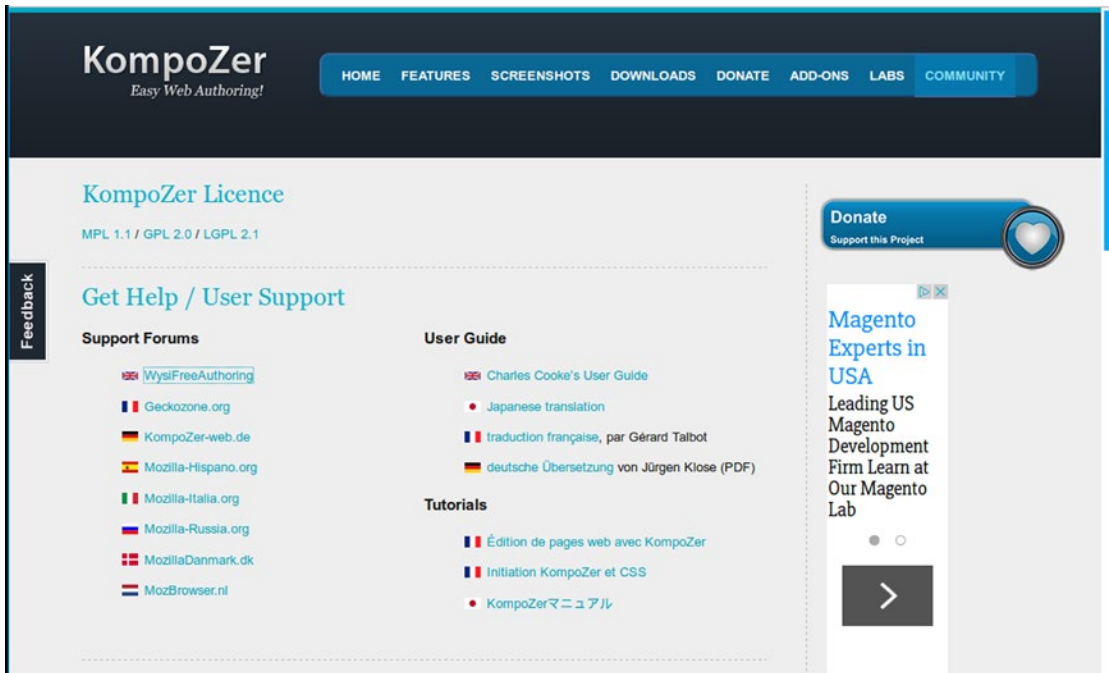

**Figure 7-5.** The Get Help/User Support page (With permission © KompoZer Development Team 2015)

## BlueGriffon: A New WYSIWYG Content Editor for the Web

BlueGriffon 1.7.2 is free to download and is available for Windows, Mac OS X, and Linux. It is an intuitive application that provides web authors (beginners or advanced) with a simple user interface. BlueGriffon aids in the creation of visually exciting websites and does not require extensive technical knowledge about web standards.

**Here are a few facts about BlueGriffon at a glance:**

- **Alternative To:** Adobe Dreamweaver
- **Website:** [www.bluegriffon.org](http://www.bluegriffon.org)
- **License:** MPL 1.1/GPL 2.0/LGPL 2.1 Tri-License, Proprietary License for Most Add-Ons
- **Current Version:** 0.7b3
- **Potential Savings:** \$19.99 per month

Technically, Gecko resides inside BlueGriffon. The document you edit will look exactly the same in Firefox. There are numerous add-ons available to enhance functionality. Project Manager, CFS Stylesheet Editor, Word Count, MathML Editor, and Full Screen View/Edit are add-ons you must pay for, but Fire FTP and Dictionaries are free to download.

After installing BlueGriffon, the Document Type Wizard can lend its assistance (Figure 7-6).

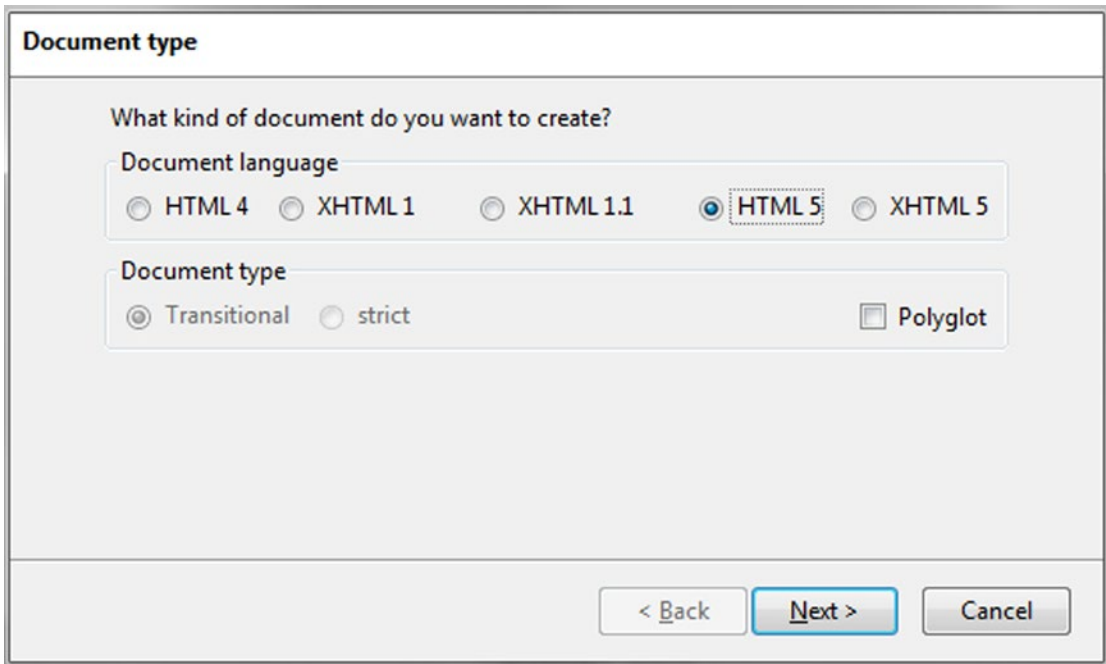

**Figure 7-6.** The Document type wizard

## Feature Highlights

The following are some highlights of the features offered:

- The editor works much the same way as the one in KompoZer, but it seems there has been some additional consideration put into the process of building websites, as well as the editing the HTML and CSS files. Also, because of HTML5, there are some new additions to the toolbar.
- Body text is not always the default. In KompoZer, the default text was *body text*. You had to select *paragraph* at the start of each new section. If headings were used, they had to be assigned, and then, before exiting the heading line, *paragraph* had to be selected. With BlueGriffon, when you exit the heading line, *paragraph* is selected as the type of text for your content.
- The Link dialog has been greatly improved. If something is on the clipboard when you open the link dialog, it is automatically copied to the file path line. This makes linking to external resources very easy. Open the page in your browser and copy the URL. When you open the link dialog, you won't have to paste the link in the file path box. There is a folder to the right of the file path box; it will still open the explorer-style file path box, so you can easily select and link to local files.

- CSS editing shortcuts are available if you hand-code your CSS files. When you type the opening curly bracket, the closing curly bracket appears simultaneously, with the cursor in-between the brackets. There is a list of possibilities from which to choose from when you begin to type a rule. When you type the colon, the closing semicolon also appears, and when you begin to type a value, a list of possible values automatically appears.
- BlueGriffon opens up tabs from your last session in the blink of an eye. There is a checkbox in the preferences on the file tab to *restore last session's tabs*. With the box checked, when the program launches, it opens the page(s) that you were last working on. This can be a very useful feature.

As with all software, there are pros and cons. Some of the pros that have been cited are that it is W3C standards-compliant, it supports HTML5, and there are built-in CSS and SVG Tools. Also, BlueGriffon is available for Windows, Mac, and Linux. The cons listed were no documentation, no JavaScript or PHP tools, and that the file transfer protocol is not included.

## BlueGriffon Support

The Discussions section of the Community page is the primary support resource from the website (Figure 7-7). There are also quite a few video tutorials on YouTube.

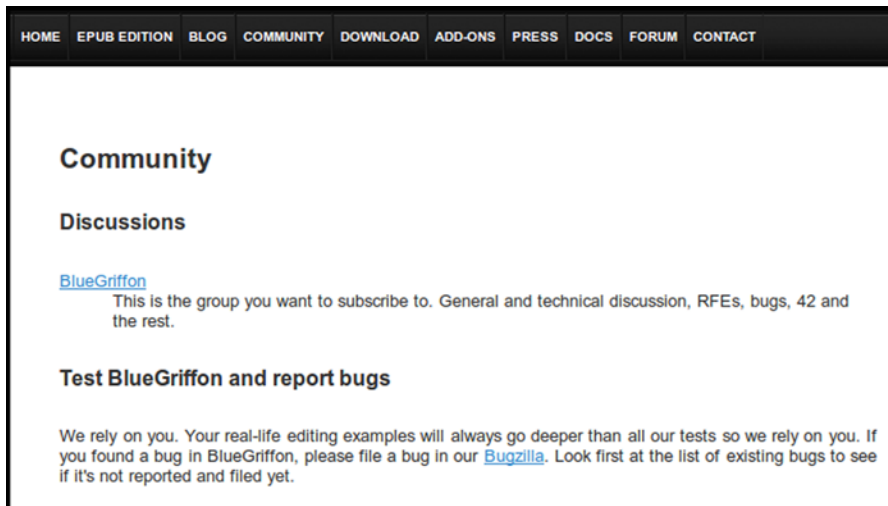

Figure 7-7. BlueGriffon Community page

## Chromium: Where Google Chrome Gets Its Code

Chromium is an open source web browser project from which Google Chrome draws its source code. The two browsers basically share the majority of code, although there are some differences between features, and each has its own different licensing.

**Here are a few facts about Chromium at a glance:**

- **Alternative to:** Mozilla Firefox
- **Website:** [www.chromium.org](http://www.chromium.org)
- **License:** BSD license, MIT license, LGPL, MS-PL, and MPL/GPL/LGPL tri-licensed code, plus unlicensed files
- **Operating System:** BSD, Linux (+GCC v4.6 & +GTK v2.24 & +Glibc 2.15), OS X (10.6 and later), Windows (XP SP2 and later), Android (4.0 and later)
- **Platform:** Cross-platform

Google's intention was that Chromium would be used as the name for the open source project, so that the final product name would be Chrome (chrome metal plating is derived from chromium). Interestingly, other developers have taken the chromium code and released versions under the same name.

## Feature Highlights

The following are a couple of the major features and the focus of the Chromium project:

- It's a tabbed window manager for the Web. Rather than being a traditional browser application, it works more in a "shell fashion."
- The application has been designed to present a minimalist user interface. The application's developers claim the program "should feel lightweight (cognitively and physically) and fast."

In January 2011, the Chrome Product Manager announced that Chrome would no longer support H.264 video format for its HTML5 player. In 2013, Cisco opted to make the H.264 codecs open source, and even cover the costs of any fees required. As of the end of 2013, Chrome continues to support H.264. Linux operations that distribute Chromium may add support for other codecs to their customized versions.

Examples of other browsers based on Chromium are [CodeWeavers CrossOver Chromium](#) (an unofficial bundle of a Wine derivative) and Chromium Developer Build 21 for Linux and OS X, which was released in 2008 by CodeWeavers as part of a crossover project.

A rebranded version of Chromium for 32-bit Windows 7, Vista, and XP, Comodo Dragon is produced by the Comodo Group. The developer claims that it provides improved security and privacy features.

CoolNovo, which was referred to as ChromePlus prior to 2012, is a Chromium-based browser for Windows and Linux. It adds features such as mouse gestures, link dragging, and IE tabs.

You might ask, what is Cốc Cốc? Well, it is a freeware web browser focused on the Vietnamese market. Developed by the Vietnamese company Cốc Cốc, the application is based on Chromium open-source code for Windows. Another application, [Dartium](#), is a very unique build of the Chromium browser, and includes the Dart VM, which is maintained by Google.

Summarizing, Google's Chrome seems to be the premier web browser choice for everyone from the day-to-day casual user right to the code-designing auteur.

## Firefox: The Open Source Browser That Respects Privacy

Mozilla Firefox (known simply as Firefox) is a free and open-source web browser developed for Windows, OS X, and Linux, with a mobile version for Android. Produced by the Mozilla Foundation and its subsidiary, the Mozilla Corporation, Firefox uses the Gecko layout engine to render web pages. Firefox implements current and anticipated web standards into its browser.

**Here are a few facts about Firefox at a glance:**

- **Alternative to:** Internet Explorer, Chrome
- **Website:** [www.mozilla.org/firefox](http://www.mozilla.org/firefox)
- **Current Version:**
- **License:** MPL 2.0
- **Operating System:** Windows, OS X, Linux, Android, Firefox OS

As of early 2015, Firefox had approximately 20% of worldwide usage as a “desktop” browser. According to different sources, it is the third most popular web browser and it is still the most popular in several countries as a desktop browser, including Iran, Indonesia, and Germany. As of the end of 2014, there were half a billion Firefox users around the world, according to Mozilla.

Firefox has long since been considered superior to programs like Internet Explorer. If you’ve had to deal with security breaches and download problems in the past, Firefox may be a better choice. Firefox is often considered to be among the fastest and safest web browsers available. It does, of course, have some disadvantages, including compatibility and memory issues.

Several advantages to keep in mind regarding Firefox:

- **Speed:** Firefox is considered to be the fastest browser when it comes to downloading. Not only do apps and files download faster, but users get a record of all their downloads in the form of a table, so they can erase or move them at their discretion.
- **Security:** Firefox contains some advanced security measures that can help to protect the computer from spyware and even certain viruses. Included in the program is a state-of-the-art pop-up blocker, which stops almost 100% of pop-ups.
- **Tabbed Browsing and Other Advanced Features:** Tabbed browsing, which is becoming the standard in web browsers, allows the user to open an unlimited number of pages in a single window. This means if the computer is powered down or loses power by mistake, the browser will remember which websites were previously open, and then offer to restore the last session.

As with all prime advantages, there are some disadvantages:

- **Compatibility Issues:** Compatibility seems to be the main disadvantage of using Firefox. In this browser, some websites do not view properly, and require the user to open them with Internet Explorer.
- **Memory:** Unfortunately, Firefox takes a lot of memory to run. Even those with an up-to-date computer have found that it becomes hard to run the browser when several other programs are open. At times, the software tends to freeze and close when too many tabs are open simultaneously. This is why the brand invested heavily in creating a recovery memory feature.
- **Interrupted Service:** Downloads, unfortunately, cannot be resumed if they are interrupted. This may not be a big deal for those who have cable or DSL service, but anyone still on a dial-up connection may encounter many problems because of it. Not a widely known fact, the browser was designed for people using high-speed Internet, which means dial-up users can run into many problems when using Firefox.

The Firefox Project has undergone a handful of name changes. Originally it was called Phoenix (the mythical firebird that rose from the ashes of the one before it). In this case, Firefox rose from the “ashes” of Netscape’s Navigator, which died a sad death under the heels of Microsoft’s Internet Explorer. Phoenix was

later renamed because of trademark issues; however, the Mozilla Foundation stated that the browser would always bear the name Mozilla Firebird to avoid confusion. After further pressure from Firebird, in 2004, Mozilla changed the name once again, to Mozilla Firefox. Interestingly, for an abbreviation, Mozilla prefers Fx or fx; however, it is most often abbreviated as FF.

## Feature Highlights

Firefox provides an environment for web developers to use built-in tools, such as the error console, the DOM Inspector, or other extensions, such as Firebug.

- Firefox includes a wide variety of features, including tabbed browsing, spell check, incremental find, smart bookmarks, live bookmarking, a download manager, private browsing, location-aware browsing (also known as geolocation, based on a Google service,) and an integrated search system that by default uses Google in most localizations.
- Additional functions may be added through extensions created by third-party developers.

Firefox maintains its high level of security through a sandbox security model. This limits scripts from accessing data from websites based on the same origin policy. For authentication purposes, it also provides support for many things, from smartcards to web applications. It utilizes SSL/TLS to protect communications with web servers using strong cryptography when using the HTTPS protocol. Regardless of an HTTPS or HTTP URL, Firefox now supports HTTP/2.

Mozilla actually offers a “bug bounty” of up to \$3,000 cash to programmers and researchers who discover severe security holes in Firefox.

Firefox generally has fewer publicly known unpatched security vulnerabilities than Internet Explorer, which is often cited as a reason to switch from one to the other. A 2006 study by Symantec demonstrated that Firefox had surpassed other browsers in a number of vendor-confirmed vulnerabilities that year. It was found that these vulnerabilities were patched much quicker than those found in other browsers; Firefox’s vulnerabilities were fixed one day after the exploit code was made available, on average, compared to nine days for Internet Explorer. Pundits still agree that overall, Firefox has fewer security vulnerabilities than IE.

## Summary

In this chapter, you looked at three no-cost options for building websites. WordPress, although capable of creating websites, is primarily a tool for creating blog sites. Blogging is an effective means for business to stay connected to their customer base. KompoZer and BlueGriffon are both website creation tools that are free alternatives to the likes of Adobe Dreamweaver.

In this chapter, you looked at two web browsers. Chromium (where the code for Chrome originates) is described by the developers as a minimalist application, being cognitively and physically lightweight and fast. Firefox is lauded for its emphasis on privacy.

In the next chapter, you’ll look at some free content management solutions.

## CHAPTER 8



# Content Management Solutions

This chapter takes a look at the following alternatives to expensive CMS programs such as Microsoft SharePoint:

- **Drupal:** An open source, community-based alternative
- **concrete5:** An open source content management system
- **GetSimple CMS:** A simple, open source content management system

## Drupal: An Open Source, Community-Based Alternative

Drupal is a free software application that allows users to easily organize, manage, and publish their content with a seemingly endless variety of customization. Drupal is open source software that is developed and maintained by a group of over one million users and developers. Drupal is distributed under the terms of the GNU General Public license. Like other programs under the GPL, it is free to for anyone to download and share with others. This open development model means that individuals are continuously working to make sure Drupal is a cutting-edge platform that can support the latest technologies offered on the World Wide Web. The Drupal project's principles encourage standards, modularity, ease of use, and collaboration.

### Here are a few facts about Drupal at a glance:

- **Alternative to:** Microsoft SharePoint
- **Website:** [www.drupal.org](http://www.drupal.org)
- **License:** GPL Version 2 or Later
- **Current Version:** 7.38
- **Operating System:** Cross-platform
- **Potential Savings:** \$5.00 per user per month

Drupal is used as a backend framework for approximately 2.1% of all websites worldwide. This includes sites ranging from personal blogs to corporate, political, and government sites. It is also recognized for business collaboration and knowledge management.

Drupal Core contains basic features commonly found in most content management systems. These features include user account registration and maintenance, managing menus, taxonomy, customized page layouts, RSS feeds, and system administration.

By the end of the first quarter of 2015, there were more than 30,000 free community-contributed add-ons, known as contributed modules. These are available to alter and/or extend Drupal's capabilities, and to add new features or customize the program's behavior and appearance.

The Drupal community has in excess of one million members and 31,000 developers. And although Drupal offers an advanced programming interface, basic website installation and administration of the framework does not require programming skills.<sup>1</sup>

## Feature Highlights

The following are some of the features offered by Drupal:

- **Mobile friendly:** Built-in themes and administration pages are quite easy to use on mobile devices. The new admin toolbar is mobile from the start. Tables shrink properly. The new administration properties feature a back-to-site button that leads back to the last front-end page.
- **Multilingual capabilities:** When you need to establish a web presence for a global audience, Drupal 8 can speak your language, whatever it may be. This application can translate anything in the system with the built-in user interfaces. Another great facet of the program is that you can get software translation updates automatically from the Drupal community.
- **Configuration management:** CM keeps accurate records of all important details as content is configured and/or revised. This program comes with a file system based on the CM system, which makes it simple to transport configuration changes, such as new content types, fields, or views, from development to production.
- **Accessibility:** For standard accessibility technologies, including WAIARIA, Drupal 8 has added extensive support, and developers have been working to provide more semantic HTML5.

Other notable features include built-in web services, effortless authoring, fun and fast streaming, and the views, which are all done with an industry standard approach. With better markup with HTML5, and more field power, Drupal 8 could still use some assistance in preparing for its first release. There is excitement amongst the mentors of the Drupal 8 program, and eagerness to get new people involved because there is always something that can be learned from peers and mentors alike.<sup>2</sup>

Although the features list covers all the new developments in Drupal 8, keep in mind that Drupal 7.38 was released in June of 2015. Drupal, in its effort to utilize the community's knowledge and experience, has established a security bug bounty program for Drupal 8 (Figure 8-1). They will pay you anywhere between \$50-\$1000 per issue found; the more serious the issue, the more you will be paid. It's as easy as downloading a copy of Drupal 8, and finding security issues such as XSS, SQL injection, CSRF, access bypass, etc. For more information, go to the Drupal 8 Security Page at [www.drupal.org/drupal8-security-bounty](http://www.drupal.org/drupal8-security-bounty).

---

<sup>1</sup>[www.drupal.org](http://www.drupal.org)

<sup>2</sup>Wikipedia, "Drupal" (original article by Dries Buytaert, founder and leader of Drupal CMS), June 2015

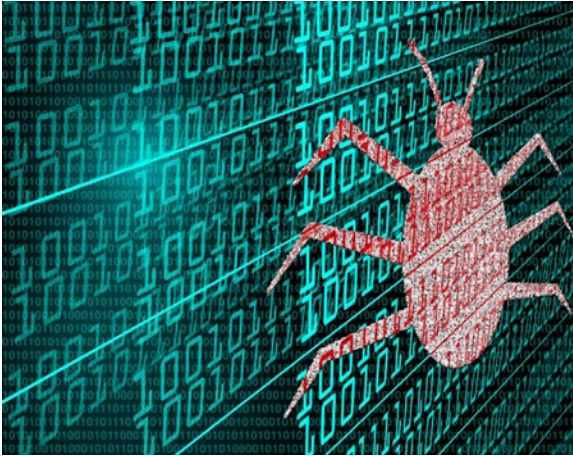

**Figure 8-1.** Drupal has established a “bug bounty” program for Drupal 8 that pays between \$50-\$1000 per issue

## concrete5: An Open Source Content Management System

The free and open source concrete5 is a content management system for publishing content on the Web and on an intranet. For those seeking a viable alternative to Microsoft SharePoint, it is well worth your time.

- **Alternative to:** Microsoft SharePoint
- **Website:** [www.concrete5.org](http://www.concrete5.org)
- **License:** MIT
- **Current Version:** tk
- **Potential savings:** \$5.00 per user per month

### Feature Highlights

Here is a quick look at some of the features offered by concrete5:

- **Easy to use:** Provides an intuitive experience that everyone can edit.
- **Easy to theme:** Basic HTML code can be converted into a concrete5 theme in a matter of minutes.
- **Easy to extend:** The flexible architecture of concrete5 makes response easier as clients get involved.
- **Concrete5 is free:** It is a free CMS solution that runs on a web server. The developers of concrete5 partnered with some budget hosts so you can quickly get started.

One of the most attractive features of concrete5 is that it is a very easy program to use (Figure 8-2). For example, once you log in, every single page of your website has an editing toolbar. If you see something you want to change, all you have to do is simply click the Edit button and make your changes.

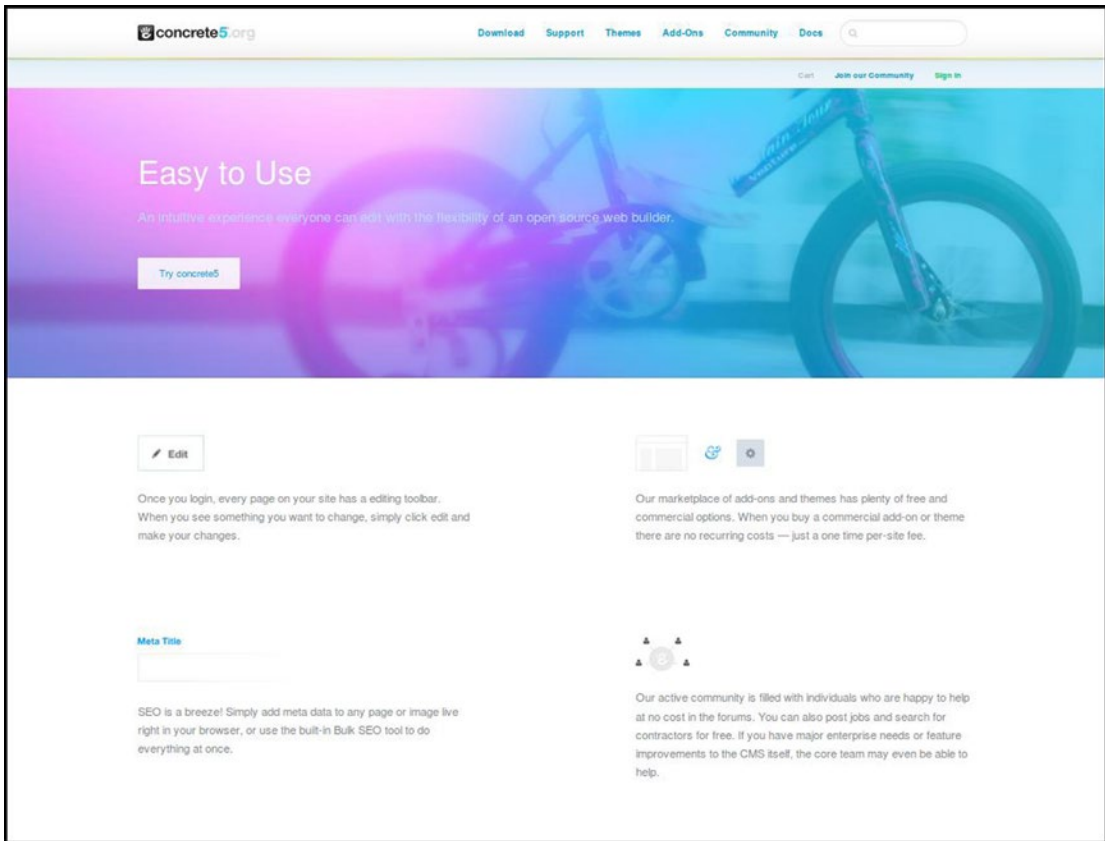

**Figure 8-2.** One of the attractive features of concrete5 is ease of use. (Used with permission by © PortlandLabs 2015)

The program can convert basic HTML into a concrete5 theme in just a few moments. It’s as easy as copying and pasting a line of PHP code for any area you want to be able to edit, and that’s it. The program also presents a showcase of sample websites created with concrete5. This lets you see the great variety of sites that can be created with this application. On the Themes page, there is a marketplace of themes available; some are free and some are paid themes (Figure 8-3).

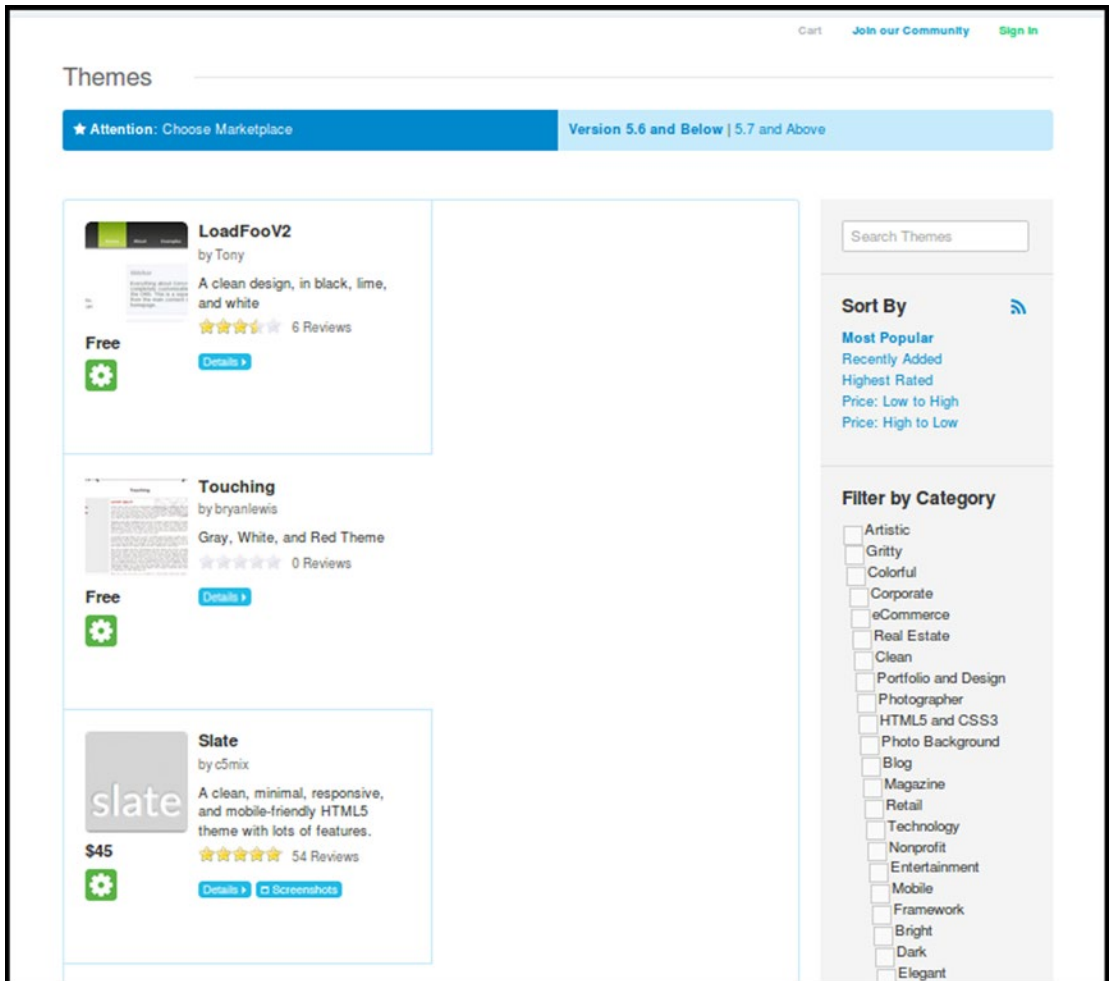

**Figure 8-3.** There are a wide variety of themes available. (Used with permission by © PortlandLabs 2015)

While concrete5 is free and open source, it requires paying a service to host your site. The concrete5 Team can provide this service (and you can be assured of top-notch support; you'll also be supporting the concrete5 project).

Of course, there are other options available. The concrete5 Team maintains a relationship with several budget companies that provide budget hosting.

## concrete5 Support

There is a great deal of support available for concrete5. The recommended place to check first is the *Free Help* page under the *Support* tab (Figure 8-4). The documentation provides access to images, videos, code samples, etc. The Forum is another place to seek help from other users. If you're familiar with IRC (*Internet Relay Chat*), there is an active community on the freenode network willing to help out: it can be accessed at `irc.freenode.org`, `#concrete5`. There are also plenty of tutorial videos posted on YouTube that will help you get up and running quickly.

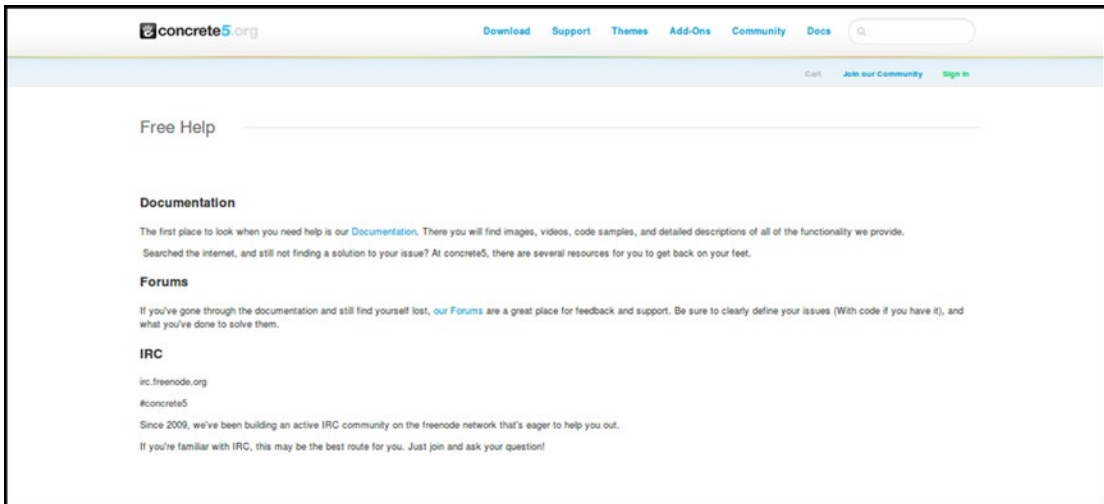

**Figure 8-4.** The Documentation link on the Free Help page is the best place to start. (Used with permission by © PortlandLabs 2015)

## GetSimple CMS: A Simple, Open Source Content Management System

GetSimple CMS (not to be confused with GetSimple.net, a web hosting service) is a free and open source website content management system. Early versions were designed for the “1 to 15 page brochure site,” and elaborate features were left out in favor of simplicity.

**Here are a few facts about GetSimple CMS at a glance:**

- **Website:** <http://get-simple.info>
- **License:** GPL 3, Open Source, Get-Simple.info
- **Operating System:** Cross-platform

GetSimple CMS is intended to be simple, fast, and easy to use. Based on PHP and released under the General Public license (GNU), GetSimple saves all data to structured XML files instead of using a database to store information. By doing this, it makes the application belong to the group of flat file web applications, which can be run without a database. Important to note, the system’s memory footprint is low, which makes it suitable to be installed within a shared hosting situation. It provides online documentation in a wiki form, and an active community can be located on the GetSimple website.

### Feature Highlights

Here are some of the features offered by GetSimple CMS, adapted from the website:

- Has proven to be highly extensible, and many important features can be added as plug-ins
- A MySQL database is not required
- Integrated backup system

- Undo actions in system backend
- WYSIWYG text editor, CK editor
- Image and file management
- Single-level menu management
- Theme selector and editor
- Plug-in manager
- Component editor

The original concept was simply to provide a way to maintain a website without knowledge of HTML via a program that presented a clear, user-friendly interface. In order to create a new GetSimple website, you must know how to use FTP and have a basic knowledge of HTML.

To check out the GetSimpleCMS demo, go to [OpenSourceCMS.com](http://OpenSourceCMS.com). You'll be provided with a generic username, password, and control panel link.

Once you upload the system files to a web server, the setup is complete. The final configuration is made easy by using the system's web-based install wizard; some hosting providers offer preconfigured GetSimple installations.

An XML-based, stand-alone program that doesn't use MySQL to store information, GetSimple is a fully independent and light content management system. The interface has been loaded with features that every website needs, but with nothing it doesn't. It is considered by most to be truly the simplest way to manage a small business website. Since it doesn't need a MySQL database, it was built specifically for the small site market.

To prevent problems, GetSimple has included "undo" into almost every action you can take, keeping you free from headaches when those inevitable mistakes are made. Since you can "undo" pretty much anything you do, this feature is based on eye-opening ideas such as explaining how warning messages never work as planned.

One of the top priorities of Helge Sverre, the developer of GetSimple CMS, was to design a user interface that was simply the best in its class. As he states in the GetSimple CMS Mission Statement, "I want our admin panel and UI to be better designed than any other comparable CMS out there. This may be more selfish than anything, but what designer wants his/her client to log into the admin panel and see a cluttered mess of cheap, non-intuitive icons that give no value to what that client needs to do? From studying my competing 20 CMSs over the last couple months, this should not be hard."

One of its goals is not to bloat its software with hundreds of little-used theme functions, so GetSimple provides "how to" documents showing how to create a custom theme (Figure 8-5).

Because it was specifically designed for the small site market, GetSimple utilizes XML rather than a larger, perhaps overwhelming, database such as MySQL. The majority of small businesses only need to be able to easily update the site; they don't require many extraneous and rarely used features. GetSimple's ultimate goal is to assist in managing small websites efficiently and effectively.

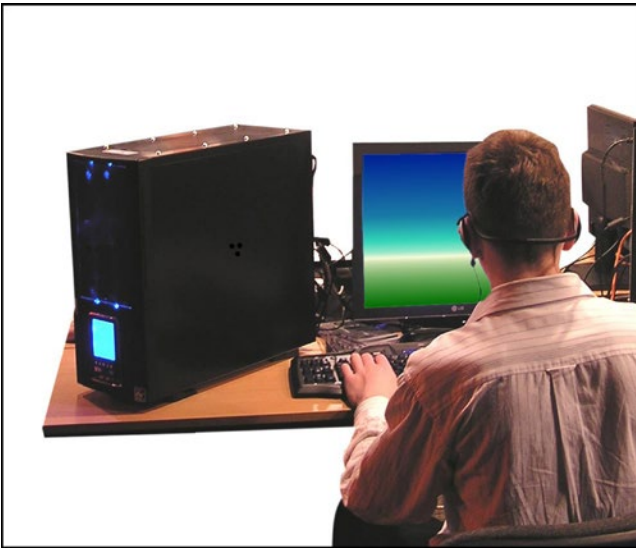

**Figure 8-5.** GetSimple provides “how to” documents on creating custom themes

## GetSimpleCMS Support

The best place to start is the Documentation and User Guide Wiki. There you will find information about what GetSimple CMS is for, what others are saying about it, and getting started.

There is an active community on the Support Forum where help can be sought out if needed. Additionally, there are also several helpful video tutorials on YouTube that will get you up and running in short order.<sup>3</sup>

## Summary

In this chapter, you looked at three free options for content management systems. For those seeking alternatives to paid systems, Drupal, concrete5, and GetSimple CMS are great options.

In the next chapter, you’ll take a look at several options for network security, password security, and free anti-virus programs.

---

<sup>3</sup>[www.get-simple.info](http://www.get-simple.info)

## CHAPTER 9



# Network and Security Utilities

Security is always a high priority in business. If you're on budget, but you require solutions for areas such as network security, password security, antivirus and mobile device privacy, there are some no-cost options. Here's a look at the software programs covered in this chapter:

### Network Security Auditing:

- **Nmap:** A free and open source utility for network discovery and security auditing

### Password Management:

- **KeePass:** A free and open source password manager that can be helpful for keeping your passwords secure if you have an online presence

### Packet Analyzer:

- **Tcpdump:** A powerful command line packet analyzer

### Antivirus Protection:

- **Avira:** Powerful, free antivirus Protection for PC and Mac
- **Clam AV:** An open source cross platform antivirus solution

### Android and iPhone Privacy:

- **Open Whisper Systems:** Open source security for mobile devices helps keep your texts and conversations private and secure

## Nmap: A Free and Open Source Utility for Network Discovery/Security Auditing

The primary purpose of the Nmap application is security auditing by detecting and locating hosts and services on any given computer network (Figure 9-1). In order to do this, Nmap sends packets that are specifically tailored to the target host, at which point the responses are analyzed. Host discovery and service, and operating system detection, are among the many features Nmap offers for probing computer networks. During a scan, Nmap acclimates to various network conditions, such as latency and congestion. While a professional developer originally wrote this software, Nmap is now further developed and refined by the user community.



*Figure 9-1. Nmap conducts security audits by detecting and locating hosts and services on computer networks*

Nmap is commonly used to audit the security of a device or firewall by identifying the potential network connections. Determining open ports on a target host is another regular use, as are network inventory, network mapping, maintenance, and asset management. While identifying new servers and generating traffic, the security is regularly being audited by finding and exploiting vulnerabilities in a network.

**Some facts about Nmap at a glance:**

- **Website:** <https://nmap.org>
- **License:** GPL Version 2
- **Current Version:** 6.49
- **Operating System:** Cross-platform

Users will find many benefits to using Nmap. For example, it has a simple installation and front end. With minimal effort, it will give a strong result, making it one of the easiest software products available. Nmap will map the network and ports with the number one port scanning tool.

## Feature Highlights

Here are some of the features offered by Nmap:

- **Host discovery:** This allows the program to identify hosts on the network.
- **Port scanning:** This application can't estimate the open ports on target hosts.
- **Version detection:** Nmap can retrieve data network services on remote devices, and then determine the application name and version number.
- **OS detection:** This feature allows the determination of the operating system and hardware characteristics of network devices.

- **Scriptable target interaction:** By using the Nmap scripting engine and Lua programming language, Nmap can further provide information on targets, including reverse DNS names, MAC addresses, and device types.
- **NSE scripts:** This feature can detect vulnerabilities, misconfiguration, and security-related information around network services.

Nmap was created to quickly scan large networks. It is because of this that it is regularly used for network inventory security audits. While doing this, the user is able to see what types of services a host is using. It is quite remarkable that when one scans a large network, the hosts appear; and for each one, data is provided regarding which OS is running, the service and version of that OS, which firewall is used, etc. This information is meaningful because some older versions may have known security issues that could damage the entire machine. Armed with this knowledge, you can update to the latest version, decreasing the potential for harm.

Nmap displays detected ports in a table. For each port that is detected, a list of the port's number, protocol, state, and version is displayed. The state can be listed as open, closed, filtered, or unfiltered. The difference between open and closed ports is that open ports listen for packets or connections on that port, while there is no such service on closed ports. On filtered ports, there is a firewall blocking Nmap, preventing it from detecting if it is open or closed. When the port is responsive to Nmap's probes (but whether open or closed is undetermined), Nmap will classify that port as unfiltered. While this does occasionally happen, it is very rare; the status of ports usually falls under the categories of open, closed, or filtered.

Nmap offers additional information on targets. This could consist of reverse DNS names, device types, operating system guesses, and MAC addresses. Finding a MAC address and reverse DNS appear to be the most highly-utilized features by consumers. Nmap's attempts to guess the OS can be a bit hit-and-miss, but that occurs even with expensive programs.

For those new to Nmap, the front end is convenient. You can easily use it to pass different preconfigured parameters to Nmap without remembering any commands, and it offers a comprehensive set of options. A convenient feature is that the program highlights some of the info in different colors so you can read it easier.

There are many benefits to using Nmap. To begin, it is powerful enough to satisfy most individual's needs but it offers a simple installation process. It is also one of the smallest software packages of its kind (0.6 MB) and can be easily deployed in mini-distributions. Nmap is considered one of the best software applications for security auditing, and it can definitely be a good starting point for people who want to explore security options.

The only drawback in functionality is Nmap's OS guessing game, mentioned above. Additionally, a more aesthetically pleasing, sleek front-end would create a better first impression of this program.

## Nmap Support

Becoming familiar with the *Reference Guide* is always recommended. There are a good number of tutorial videos on YouTube that should prove useful.

## Keepass: A Free and Open-Source Password Manager

KeePass is a vital security management tool. Professionals suggest that one of the most important things to do is to protect one's online security. Assigning a unique, lengthy, randomized password for every single site or account you use, and keeping track of the all those passwords, would pose a challenge for even the most organized person. This is where KeePass comes in handy.

KeePass is a free and open-source password manager that is compatible with the following: Windows, Linux, Android, Mac OS X, and with unofficial ports for iOS.

**Here are a few facts about Keepass at a glance:**

- **Alternative to:** Steganos Password Manager 16
- **Website:** [www.KEEPASS.INFO](http://www.KEEPASS.INFO)
- **License:** GNU GPL Version 2+
- **Current Version:** 2.29
- **Operating Systems:** Windows, Mac OS, Linux
- **Potential Savings:** \$24.99 (5 PC Edition of Password Manager 16)

KeePass is a very handy application. Instead of writing passwords down here and there (and worrying about where they are when you can't find them), KeePass assists you by storing all of your passwords securely in the program's database. You need to remember only one "master" password to access your stored passwords (Figure 9-2).



**Figure 9-2.** KeePass stores all of the passwords you create, so you only need to remember one master password

## Feature Highlights

Here are the main features of KeePass:

- **Password management:** Passwords stored in this application's database can be further divided into manageable groups. Each group can have its own separate identifying icon.
- **Extensible:** Offers a number of different configuration options.
- **Tracks passwords:** KeePass tracks the creation time, modification time, last access time, and expiration time of each password stored, allowing you to attach and store a password on files and text notes.
- **Import and export:** The password list is exportable to various formats, such as TXT, HTML, XML, and CSV.
- **Multuser support:** This application supports simultaneous access and changes to a shared password file by utilizing multiple computers, often using a shared network drive.

- **Autotype, global hotkeys, drag-and-drop:** KeePass provides support for these features. KeePass can minimize itself and type the information of the currently selected entry into such things as dialogs, web forms, etc.
- **Browser support:** The available autotype functionality works very well with all browsers. There is a Keeform extension that allows users to open websites with Internet Explorer and Mozilla Firefox. For Firefox, there is an additional extension called KeeFox, which will automatically connect to KeePass when a user needs access to a password.
- **Built-in password generator:** This generates random passwords, and random seeding is available for user input.
- **Plug-ins:** KeePass possesses a plug-in architecture, and there are a variety of plug-ins available on the KeePass homepage. One thing to bear in mind is that plug-ins may compromise the security of KeePass because they are written by independent authors, and these authors have full access to the database while developing their plug-ins.

Unlike other competitors, KeePass doesn't automatically put your password database in the cloud, although another option is to put your password into Dropbox manually.

KeePass presents its own random password generator to ensure the user doesn't have to take on the arduous task of coming up with, and then remembering, countless lengthy, complex passwords on their own. Additionally, KeePass includes a quick-search box where one can type even a fragment of a website's name to quickly find it on the list. The list itself is created to contain thousands of records, which can be subdivided into folders and subfolders, keeping things organized.

KeePass isn't just limited to usernames and passwords; every entry has multiple alternate fields, one of which is a free-form Notes field which allows the safe storing of text of any kind.

One technique hackers use to circumvent password protection is to use a keylogger. A keylogger is a background application that secretly logs every keystroke that is typed, and that information is transmitted to the hacker. If a keylogger is installed on a user's system, an attacker could conceivably learn everything that was typed throughout the day, including all usernames and passwords.

Another protection feature that KeePass offers is its *AutoType* feature. This feature prevents the user from having to type individual website passwords by pasting them into the browser window and applying a combination of virtual keystrokes and clipboard obfuscation, making it all the more difficult for a keylogger to figure out what the password actually is. While AutoType can be temperamental, when it does work, it's extremely useful.

KeePass also lets the user enter their master database password in a prompt that is protected by UAC. This protects it from any software keylogger that isn't running with Administrator rights on the machine.

KeePass is recommended to anyone with an online presence (no matter how small) because, when a major website has its security breached, users of KeePass are unaffected, knowing their personal information remains safe and secure.

In summation, KeePass is a quality, easy-to-use, password protection system. There seem to be few bugs with the program, but there are many great security benefits. Whether a business or an individual, extra password protection is very important, especially in these times of rampant hacking. KeePass can offer peace of mind regarding your computer's safety.

## Keepass Support

Keepass is a relatively easy program to come to grips with, but if you get stuck, the *Help Center* can be found at <http://keepass.info/help>. The FAQ page is another source of assistance, as are the numerous YouTube tutorials.

## tcpdump: A Powerful Command Line Packet Analyzer

tcpdump was designed for users that need to analyze network traffic by capturing packets from a certain adapter. It is a network sniffer tool, and it can capture all the data packets that are transmitted or received through a network adapter. The program is executable in command line mode, and it allows the user to perform multiple actions by using arguments.

Information regarding captured packets may be viewed in real time using the command prompt window or recorded to a log file to assist in analyzing the packets at a later date.

### Here are a few facts about tcpdump at a glance:

- **Website:** [www.tcpdump.org](http://www.tcpdump.org)
- **License:** BSD License
- **Current Version:** 4.7.4 / 1.7.4
- **Operating System(s):** Linux, Solaris, FreeBSD, NetBSD, Open BSD, OS X, Android, AIX, and others

tcpdump works on most UNIX-like operating systems (see above). When used in those systems, tcpdump uses the libpcap library to capture packets. The software provider's website indicates that the port utilized by tcpdump for Windows is called WinDump, which uses WinPcap, the Windows port of libpcap.

## Feature Highlights

Here are a few of the features found in this program:

- **Powerful command-line packet analyzer:** tcpdump works with libpcap, a portable C/C++ library, for network traffic capture.
- **Can run remotely:** through an SSH or Telnet.
- **Writes packets to standard output/file:** tcpdump prints the contents of network packets, and it can also read packets from a network interface card, or even from a previously created saved packet file.
- **Monitor communications:** It is possible to use this program for the specific purpose of intercepting and displaying the communications of another user or computer.
- **Optional BPF-based filter:** The user may add this filter to limit the number of packets seen by tcpdump. This does render the output more usable on networks with a high volume of traffic

The information on the software provider's website indicates that Tcpdump works on most UNIX-like operating systems. When used in those systems, tcpdump uses the libpcap library to capture packets. The port utilized by tcpdump for Windows is called WinDump, which uses WinPcap, the Windows port of libpcap.

## tcpdump Support

The documentation for tcpdump ([www.tcpdump.org/index.html#documentation](http://www.tcpdump.org/index.html#documentation)) is a good starting point, and the FAQ is also a source of help ([www.tcpdump.org/faq.html](http://www.tcpdump.org/faq.html)). There are quite a few video introductions and tutorials on YouTube as well.

## Avira: Powerful, Free Antivirus Protection for Personal PCs and Macs

Avira Operations GmbH & Co. KG is a German multinational-owned antivirus software company. It provides IT security for computers, smartphones, servers, and networks, which can be delivered as both software and cloud-based services.

### A few facts about Avira at a glance:

- **Alternative to:** McAfee AntiVirus Plus
- **Website:** [www.avira.com](http://www.avira.com)
- **License:** Proprietary Freeware
- **Current Version:** 1.1.35.25717
- **Operating System(s):** tk
- **Potential Savings:** \$34.99 (McAfee annual subscription)

If you stay on the Internet a great deal, it's a wise investment to step up to Avira Pro, or something comparable. However, if you only use the Internet for short periods from time to time (and are truly on a strict budget), then you may find that the free version of Avira will suit you (however, the license for the free version of Avira is for personal use only). According to the information on their website, the free version of Avira tops the free versions of the competition (such as AVG and Avast) in degree of protection (Figure 9-3).

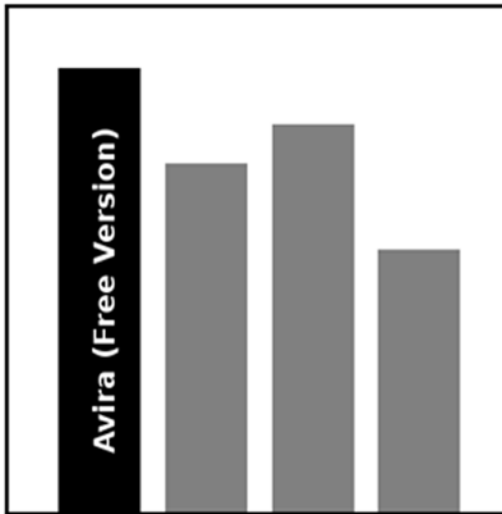

**Figure 9-3.** According to Avira's website, the free version tops the competition in degree of protection (free versions)

---

■ **Note** If you require a free antivirus program for commercial use, try NANO Antivirus ([www.nanoav.ru](http://www.nanoav.ru)). It states clearly on the FAQ page it is allowed for commercial use.

---

## Feature Highlights

Here are a few of the features found in this program:

- Comprehensive and user-friendly antivirus program that works efficiently on all computers.
- Avira AntiVir is specifically designed for personal use, not for business or commercial use.
- Rated number one by consumers in the list of the top five best free antivirus software for Windows.
- The Avira antivirus program is an effective antivirus protection against viruses, worms, and Trojans.
- Avira is integrated with rootkit detection.
- Avira offers anti-phishing protection.
- Avira offers anti-spyware protection against spyware and adware.

Viruses can be removed quickly with the *Quick Removal* feature. The scanning technology is able to open locked files and provide internal security, preventing the alteration of AntiVir's files.

It's quite clear through customer and critic ratings, and actual downloads, that Avira is a popular product. The company has been around for enough years to have refined their business model, and it provides a comprehensive, useful tool for individuals for free. They have found their niche field, and by not continuously delving into other areas of IT and software, they've stayed focused and on point on antivirus applications in other related programs.

## Avira Support

Avira is an easy program to install and run. If you encounter any problems, the Avira *Support* page should have most of the answers to any questions you have, so go to [www.avira.com/en/support](http://www.avira.com/en/support). There are several video tutorials on YouTube as well.

## ClamAV: An Open Source Cross-Platform (Including Linux) Antivirus Program

ClamAV is a cross-platform, free, open-source antivirus software toolkit used by millions of people. It is capable of detecting a wide variety of malicious software, including viruses.

**Here are a few facts about ClamAV at a glance:**

- **Website:** [www.clamav.net](http://www.clamav.net)
- **License:** GPL
- **Current Version:** 0.98.7
- **Operating System(s):** Windows, Mac OS, Linux, BSD, Solaris

A primary purpose of ClamAV is on mail servers, where it acts as a server-side email virus scanner (Figure 9-4). ClamAV was created for Unix, but third-party versions are available for AIX, HP-UX, Linux, BSD, OS X, OpenVMS, Solaris, and OSF (True 64). Starting with version 0.97.5, ClamAV is also available for Microsoft Windows. Not only is the initial program free, but future updates will be available at no cost.

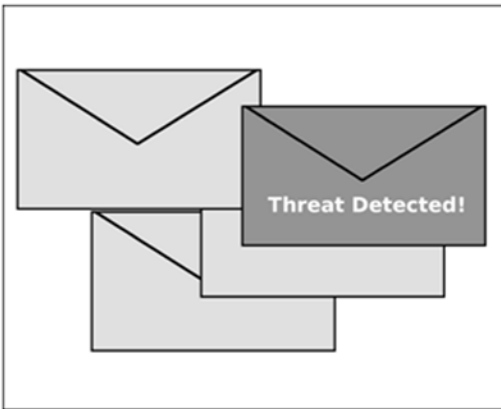

**Figure 9-4.** *ClamAV serves well as a server side e-mail scanner*

It should be kept in mind, however, that ClamAV is not a *real-time* virus scanner, meaning it does not scan when a file is read or written. To provide real-time checks, ClamAV can be used with other applications such as ClamFS (for a Unix-like OS supporting FUSE), DazukoFS (for Linux), Clam Sentinel (for Windows), and Winpooch (also for Windows).

The ClamAV engine can be dependably used to identify several kinds of files. Specifically, some phishing emails can be exposed using antivirus techniques. It should be noted, however, that false positive rates are inherently higher than those of traditional malware detection.

Despite that, ClamAV is both widely known and widely respected, keeping it in the forefront of the antivirus market. There are many reasons for ClamAV's continued success; the main ones are the following: simple installation, easy to launch, compatible with almost all MTAs, solid protection, customization, and the economic fact that it costs nothing.

## Feature Highlights

Here are the highlights as shown on the ClamAV website:

- Command-line scanner
- Melcher interface for sending mail
- Advanced database updates with support for scripted updates in digital signatures
- Virus database updated multiple times per day
- Built-in support for all standard mail file formats
- Built-in support for various archive formats, including ZIP, RAR, DMG, Tar, Gzip, Bzip2, OLE2, Cabinet, CHM, BinHex, SIS, and others
- Built-in support for ELF executables and portable executable files packed with UPX, FSG, Petite, NsPak, wwpack32, MEW, Upack, and obfuscated with SUE, YOda Cryptor, and others
- Built-in support for popular document formats, including MS Office and MacOffice files, HTML, Flash, RTF, and PDF
- Can be installed on all major operating systems including Linux, Windows, BSD, Solaris, and even Mac OSX

## ClamAV Support

You can download the *User Manual* from <https://github.com/vrtadmin/clamav-faq/raw/master/manual/clamdoc.pdf>. Numerous YouTube tutorials cover Clam Av, particularly for Linux distributions.

## Open Whisper Systems: Open Source Security for Mobile Devices

Open Whisper Systems is a non-profit group of software developers whose primary goal is to provide security and privacy for mobile devices.

**Here are a few facts about Open Whisper Systems at a glance:**

- **Website:** <http://whispersystems.org>
- **License:** GPL
- **Products:** RedPhone, TextSecure, and Private Messenger
- **Operating System(s):** Android, iPhone

*RedPhone* is the application for Android phones that provides private conversations (Figure 9-5). The following are its strong points, as shown on the software provider's website:

- Free, world-wide, end-to-end encryption for your calls, securing your conversations so that nobody can listen in.
- RedPhone uses your normal phone number to make and receive calls, so you don't need yet another identifier.
- RedPhone calls are encrypted end-to-end, but function just like you're used to.
- Free and open source, enabling anyone to verify its security by auditing the code.
- Uses Wi-Fi or data, not your plan's voice minutes.
- All RedPhone calls are free, including long distance and international.

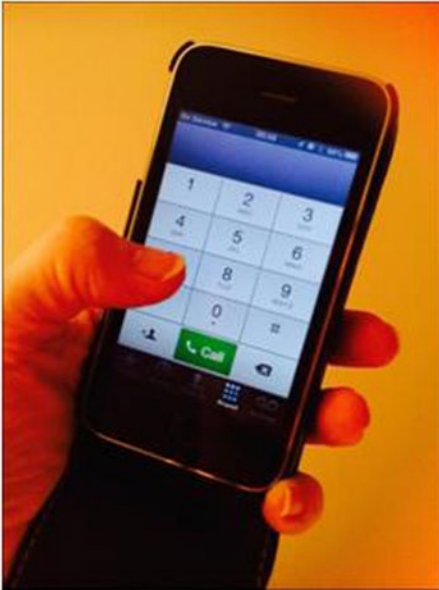

**Figure 9-5.** RedPhone provides end-to-end encryption for private conversations

*TextSecure* provides secure and private text messaging for Android phones. According to the developers, “Using TextSecure, you can communicate instantly while avoiding SMS fees, create groups so that you can chat in real time with all your friends at once, and share media or attachments all with complete privacy. The server never has access to any of your communication and never stores any of your data.”

*Signal* is the application that provides security and privacy for iPhones. The website states that it provides secure “free, worldwide, encrypted voice calls for iPhone, and is fully compatible with RedPhone for Android.”

## Open Whisper Systems Support

On the *Support* page, you can type in a question or search term, and you’ll be directed to the forum where topics related to yours are displayed. You’ll also have access to numerous articles covering various aspects such as general questions, security, etc. Although there don’t seem to be many video tutorials on YouTube, there are one or two that provide some general information.

## Summary

In this chapter, you looked at several solutions for various security measures. Nmap provides network auditing and detection. KeePass is an excellent program that manages important passwords and keeps them secure; you only need to keep up with a master password, and not worry about remembering the rest.

Analyzing packets with `tcpdump` allows the user to display the packets being transmitted or received on a network. Avira (although licensed only for personal use) is an excellent, free antivirus program ideal for computers that don’t frequent the Internet very much. ClamAV is an open source antivirus program that can be installed on numerous operating systems. Open Whisper Systems provides several applications for Android mobile phones and Apple iPhones to help keep texts and conversations secure and private.

In the next chapter, you’ll look at several Linux distributions, which, for many users throughout the world, are viable alternatives to the Windows and Mac computer operating systems.

## CHAPTER 10



# Linux: The Free Alternative to Windows and Mac OS

Microsoft Windows and Macintosh need no introduction. Certainly, most readers of this book are using Windows and the others are no doubt using a Mac. You may be wondering why anyone would consider using a different operating system. While Linux isn't for everyone, it offers some advantages that are well worth considering, such as security and free software.

This chapter introduces the reader to Linux: what it is, how it is used, and a brief history about how it came into existence. We'll then look at the advantages Linux offers over its well-known proprietary counterparts.

This chapter provides an in-depth look at Ubuntu, ostensibly the most popular Linux distribution in the world. We'll also take a brief look at two other Linux distributions: Zorin OS and Linux Mint.

## What Is Linux?

The odds are good that you've heard of Linux and know that it's related to computers. First, it should be pointed out that Linux actually refers to the *kernel*, or "core" code around which Linux distributions are built.

Essentially, Linux is a Unix-like computer operating system that falls under the model of free and open source software development and distribution, just like the open source software discussed in this book. There are many variations of Linux known as distributions, or *distros* as they're called in the parlance of those active in the Linux communities. With a few exceptions, Linux distributions are available at no cost (but donations are gladly accepted).

Linux plays a major role behind the scenes of a number of products you probably know. The ubiquitous Android operating system on of millions of mobile devices (Figure 10-1) is based on the Linux kernel. Linux.com ([www.linux.com/learn/new-user-guides](http://www.linux.com/learn/new-user-guides)) names several other Linux-based products such as TiVo digital recorders, Volvo in-car navigation systems, and Sony Bravia televisions.



**Figure 10-1.** *Android mobile devices are among the numerous Linux-based products*

Linux is the force behind millions of laptop and desktop computers all over the world. One of the most popular distributions (if not *the* most popular) is Ubuntu (Figure 10-2). There are many other popular Linux distributions as well: Debian (the distribution upon which Ubuntu is derived), Linux Mint, Zorin, Fedora, and others.



**Figure 10-2.** *Ubuntu is a highly popular Linux distribution used on millions of computers*

As mentioned in the Introduction, several city governments throughout Europe have chosen to run their computers using Linux (primarily Ubuntu) instead of Microsoft Windows. The savings they enjoy in licensing fees are significant (not to mention the free productivity software that comes bundled with most Linux distributions).

In addition to mobile devices, electronic products, laptop and desktop computers, Linux also runs many of the servers in use (Figure 10-3). IBM provides full Linux support for all of its server platforms. Ubuntu Server is significant; according to Ubuntu’s website, “Ubuntu Server is the world’s leading cloud guest OS, running the majority of workloads in public clouds today, thanks to its security, versatility, and regular updates.”



**Figure 10-3.** *Many servers in use are powered by Linux*

The majority of Linux distributions use a GUI (graphical user interface). There are several desktop environments that vary from one Linux distribution to another. The Zorin OS (which is covered in greater detail later in this chapter) is a Linux distribution that can be configured to resemble the look of Windows 7 (Figure 10-4) or Windows XP to ease newcomers into Linux.

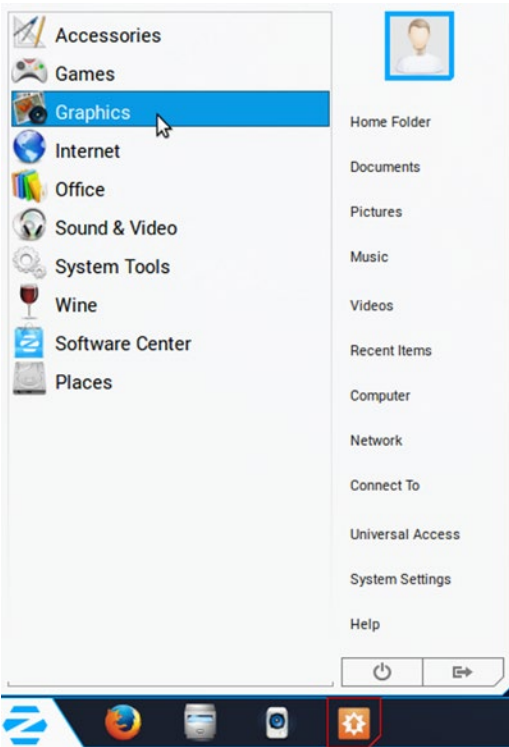

**Figure 10-4.** The Zorin OS can be configured to resemble look of Windows. (Used with permission © The Zorin OS Team 2015)

Linux systems typically employ a command line feature called *terminal* (Figure 10-5). It resembles the old DOS interface that predates Microsoft Windows. The terminal provides the user access to the system underneath the graphical interface. Although many Linux users go through their computing lives without ever (or rarely using) this command line interface, there are occasions when using it is necessary (such as the installation of certain software programs). It's a good idea for new Linux users to become familiar with the terminal feature.

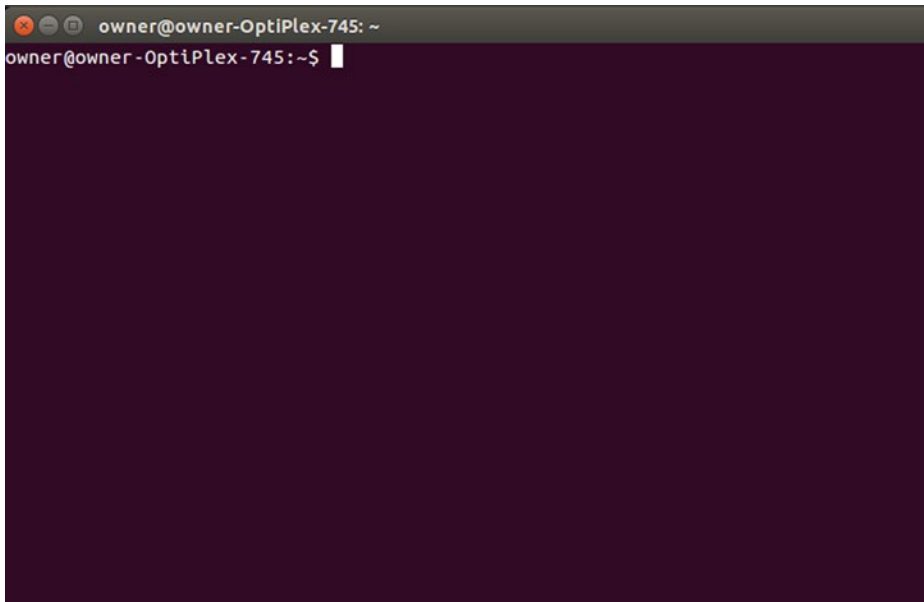

**Figure 10-5.** The terminal command line feature

Ubuntu's website provides useful details about using the terminal (Figure 10-6). To learn more, go to <https://help.ubuntu.com/community/UsingTheTerminal>.

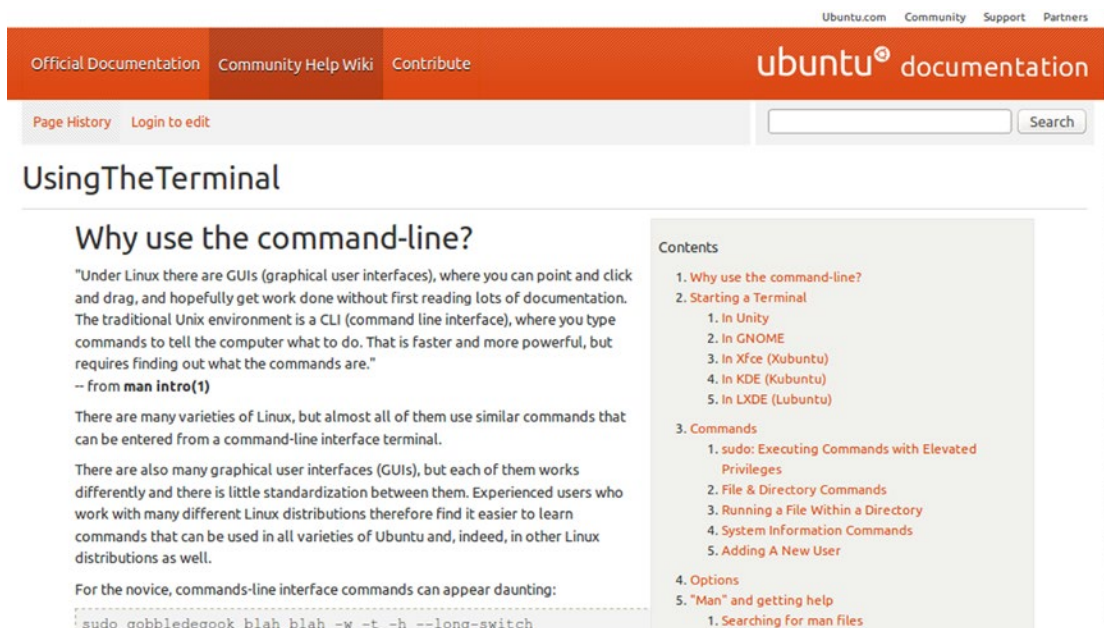

**Figure 10-6.** The Ubuntu website provides useful details about using the terminal

## A Brief History of Linux

The history of Linux is actually a fairly long story, so I will provide a very short synopsis. The origin of Linux goes back to 1991 when a Finnish student at the University of Helsinki named Linus Torvalds was working on a personal project. He was developing a free operating system kernel that anyone could build upon. Around the same time, the GNU project started by Richard Stallman in 1983 was developing a free Unix-like operating system. They were near completion, but were lacking a kernel for the operating system. Eventually, the two projects were integrated and a complete operating system was born. If you're interested in reading a more detailed account, go to the GNU Operating System website at [www.gnu.org](http://www.gnu.org) and click the tab titled *A Historical Overview of GNU*.

---

■ **Note** According to the GNU Operating System website (and despite the fact that the term Linux is so widely used), the proper designation for the operating system is GNU/Linux. Also, the terms *distribution* and *operating system* are used synonymously in the Linux world.

---

In the early days of Linux, it required operators who were knowledgeable in computer programming to use it. Because it fell under the terms of the GNU License, anyone with programming skills could alter it to suit their needs. Over the years, many distributions have been developed that have become more user-friendly.

Distributions such as Ubuntu and Linux Mint have done a great deal to increase the popularity of Linux over the past several years. Although this is debatable (at least, for the time being), some proponents of Linux believe it will surpass Windows as a mainstream operating system. It may never reach that level, but it has certainly made some great strides, and it's presumable that it will continue to grow and improve.

## The Advantages of Using Linux

There are numerous advantages to using Linux. One of the biggest is the availability of support from the community. Each distribution has its own website and user community forum, and Linux users are committed to the further development and growth of their preferred distribution. Some people (myself included) use more than one Linux distribution.

Here are several other advantages that using a Linux operating system offers:

- **With a few exceptions, Linux distributions are free.** Most Linux distributions are free to install; use it on one or multiple computers without paying licensing fees.
- **Try it out without installing.** Most Linux distributions can be tried out on your computer (without installing anything or making changes) by using a live CD, DVD, or USB stick. When using a live disc, the response time is much slower, but it does provide a general experience of trying it out. If you decide to, you can install Linux from the live disc or USB stick.
- **Linux is highly secure and stable.** Generally speaking, Linux systems aren't besieged with the number of viruses, Trojan horses, and malware that plague Windows. While Linux isn't always immune to these problems (and anti-virus protection is always warranted), because most attacks target Windows systems there are far fewer malicious programs that wreak havoc with Linux systems. Another perk is that Linux-based operating systems tend to be very stable and reliable.

- **There are many software titles available to suit most purposes.** Linux distributions typically come bundled with useful software, such as GIMP, LibreOffice, and other titles. Software is easy to acquire by using the distribution's *software repositories*. Some software titles are available for a small fee, and many others are free.
- **Strong community support.** Each Linux distribution has a community of users that are willing to help newcomers. There are also plenty of overview and instructional videos on YouTube covering just about every Linux distribution.
- **Install Linux alongside your current operating system.** Many people decide that they like Linux, but can't bring themselves to give up Windows. The good news is, you don't have to. Linux systems can typically be installed along side your Windows (or Mac) operating system. With a dual boot system, you'll be presented with a choice of which operating system to launch.
- **Older computers can be revitalized with Linux.** There are several lightweight Linux distributions (such as Puppy Linux or Lubuntu) that run well on older computers that are too underpowered for most modern operating systems (but are otherwise perfectly good machines). This is a great way to recycle older computers and relegate them to light duty, such as email, surfing the web, and word processing (Figure 10-7).



**Figure 10-7.** Older, lower spec computers can be revitalized by using one of the lightweight Linux distributions and relegating them to light duty, such as email, web browsing, and word processing

Another distinct advantage of Linux is that if you aren't satisfied with a particular distribution, you can always try another one; it doesn't cost anything except a little investment in time and perhaps a blank DVD. Each distribution has its strengths and weaknesses, so it's important to use the one that serves you in the best way possible. A helpful website to compare Linux distributions is DisrtoWatch.com (<http://distrowatch.com>). Simply select the distribution you're interested in, and it provides a summary, relevant websites, popularity, etc.

Another resource to help the newcomer become better acquainted with Linux in general is the *New User Guides* page of the Linux.com website ([www.linux.com/learn/new-user-guides](http://www.linux.com/learn/new-user-guides)).

The next section of this chapter looks closely at Ubuntu, arguably the most popular Linux distribution in the world. It also looks quickly at two other popular distributions, Zorin OS and Linux Mint. This will help illustrate how Linux distributions can differ from one another.

---

■ **Tip** Do you have an older (but perfectly good) Windows XP laptop or desktop computer you haven't used since Microsoft ceased offering support for the XP platform? Bring it back to life by trying out one of the lightweight Linux distributions; you might be able to delay the need to purchase a new computer for a long while.

---

## Ubuntu: Powering Millions of Laptops and Desktop Computers Around the World

This is the claim made on Ubuntu's website. Ubuntu has become one of the most popular Linux distribution over the past several years. First released in 2004, Ubuntu (the Long Term Support version is currently 14.04) is designed to be a user friendly, general purpose operating system. Ubuntu is a derivative of Debian, a popular Linux distribution backed by a strong community.

### Ease of Use

Ubuntu's ease of use adds to its popularity throughout the world. It even comes preinstalled on some laptop computers from manufacturers such as Dell, HP, and Lenovo.

Ubuntu employs the *Unity* user interface, which is a graphical shell of the GNOME desktop environment. GNOME stands for GNU Network Object Model Environment, essentially a graphical user interface developed for Linux by the GNOME Project. It's designed to provide Ubuntu as easily as possible. One way in which this is achieved is by docking the launcher icons on the far left of the screen. There's also a choice of wallpapers to customize the background in the *Appearance* settings. (Figure 10-8). The size of the launcher icons can be adjusted by using the slider control.

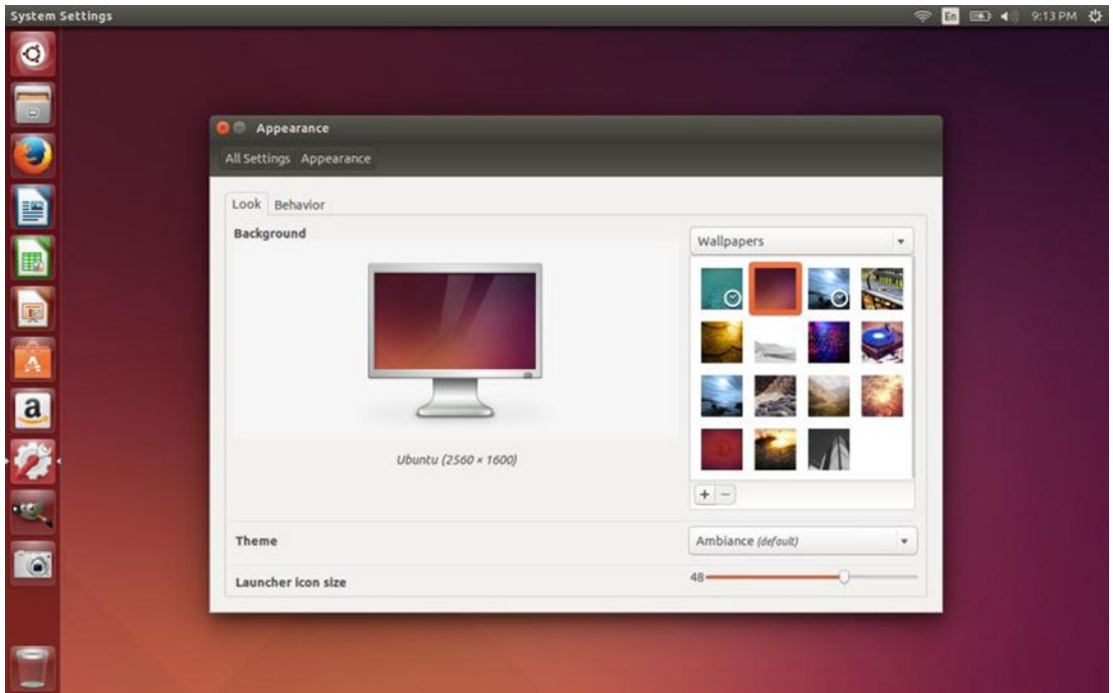

**Figure 10-8.** The launcher icons are docked on the left of the screen. The background can be customized with a choice of wallpapers

## Ubuntu Dashboard and Desktop

Ubuntu's dashboard (Figure 10-9) is a search feature that employs *Smart Filters*, making it easy to find content stored on your computer or on the Web. The *Smart Scopes* server returns the most relevant results based on your search query. It learns from your past search queries, making it more accurate over time.



**Figure 10-9.** *Ubuntu’s Dashboard makes searching for content easy*

The desktop environment differs somewhat from that of Windows or Macintosh. The program launch icons are docked on the left side of the screen. Even though this might seem a bit unfamiliar at first for those new to Ubuntu, you will quickly grow accustomed to it.

There are a number of wallpapers available to customize the appearance to your liking.

## Downloading and Installing Ubuntu

Ubuntu is free to download from the official website ([www.ubuntu.com](http://www.ubuntu.com)). There are two “flavors” available: 32-bit and 64-bit. The 32-bit version is for older computers with less than 2GB of RAM (Figure 10-10). The 64-bit version is for newer, more powerful machines. Ubuntu 14.04 is the Long Term Support version, which guarantees regular security and maintenance updates for five years.



**Figure 10-10.** The 64-bit version of Ubuntu is for newer, high spec computers while the 32-bit version is for machines with less than 2GB of RAM

---

■ **Note** The newest, most cutting-edge version of Ubuntu is 15.04, but it is only supported for nine months. However, it is recommended that new users download version 14.04 for long-term support.

---

After selecting the version of Ubuntu you want to install, it will be necessary to either burn the ISO file to a DVD or create a bootable USB stick. There are specific instructions on the Ubuntu website for how to accomplish this for switching from either Windows, Mac, or even an older version of Ubuntu (Figure 10-11).



**Figure 10-11.** Ubuntu’s website provides details about burning an installation DVD or creating a bootable USB stick

---

■ **Note** Ubuntu can be tried out by running it from either the disc or USB stick without making changes to your computer. Also, if you’re not quite ready to give up using Windows (or Mac), Ubuntu can be installed alongside your current operating system, resulting in a dual boot system.

---

## Ubuntu Software and Software Center

While Microsoft Windows is still by far the dominant force in the computing industry, there are millions of people (as well as businesses and city governments throughout Europe) who have embraced Ubuntu as a viable alternative to Windows. Ubuntu comes preloaded with lots of useful software. There are hundreds, if not thousands, of other software titles available from the *Software Center*.

One of the most significant programs that comes preinstalled in Ubuntu is *LibreOffice*, the open source office productivity suite (Figure 10-12). LibreOffice is discussed in detail in Chapter 1 of this book.



**Figure 10-12.** The powerful LibreOffice is one of the software programs preinstalled in Ubuntu

Ubuntu also comes with software to view and manage photos, video, and audio. *Shotwell Photo Manager* acquires images from digital cameras and keeps them organized. *Openshot* is a basic video editing program (similar to Microsoft Movie Maker in Windows). *Rhythmbox* is a nice utility for playing MP3 files. *Brasero* is a disc burning program that handles all of the functions necessary for writing and copying music CDs, data discs, and DVDs (Figure 10-13).

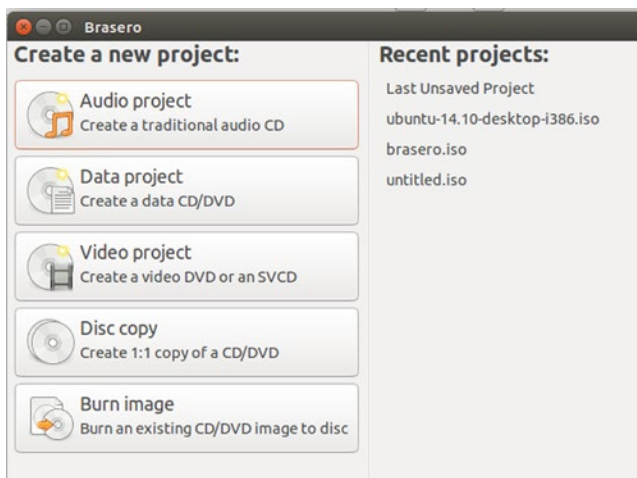

**Figure 10-13.** Brasero Disc Burner utility

There are many other software titles available from the Ubuntu Software Center (Figure 10-14). For example, if you need a vector drawing program such as Inkscape, it can be acquired from the Software Center (Figure 10-10). Clicking the *More Info* button shows a complete description of the software program is displayed. If it will suit your needs, just press *Install* and the program will be installed in short order.

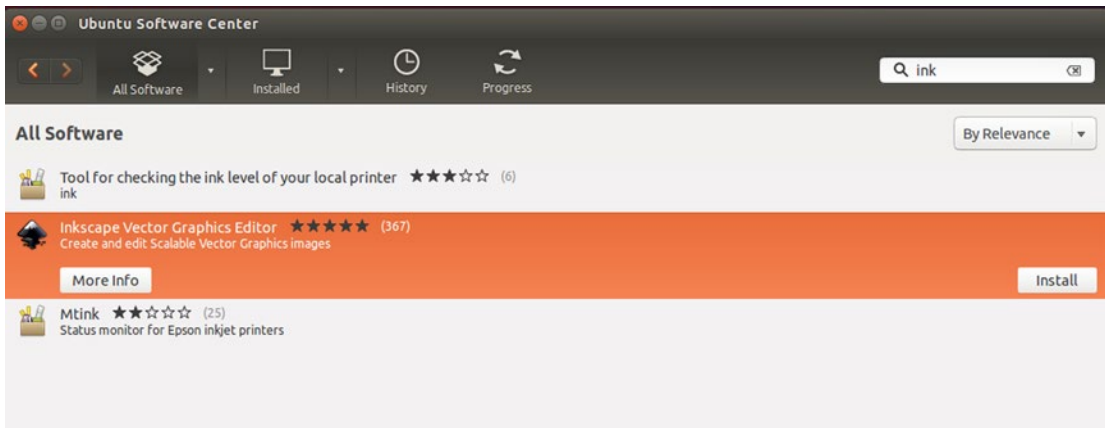

**Figure 10-14.** Acquiring and installing software from the Software Center is an easy process

This process is actually quite different from installing software on Windows or Mac systems; it's easier. Other useful software programs that can be found in the Software Center are GIMP (for editing photos), Kdenlive (for editing video), Krita (a digital drawing and painting program), and many others. There are also a variety of games available for download.

---

■ **Note** Not all of the software programs available in the Software Center are free, but the majority of them are.

---

## Running Windows Applications on WINE

Despite all of the software available for Ubuntu, some users may still be locked into using a particular Windows program. Yet another perk for Ubuntu and other Linux distributions is the ability to run many legacy Windows software programs on Linux using a compatibility layer program called WINE. WINE actually stands for Wine Is Not an Emulator, and it is free, open source software that has been around since 1993. WINE can be acquired from the Software Center or from the WINE website ([www.winehq.org/](http://www.winehq.org/)).

WINE won't support all Windows programs, so it's not a perfect solution. It is an ever evolving project, so in many cases in which a particular Windows program is a must, it might just fill the bill. The WINE website provides information about compatibility.

## Security

Ubuntu, like other Linux distributions, is very secure, relatively speaking. Anyone who has used Windows for any length of time is aware of the many threats that abound: viruses, malware, worms, Trojan horses, etc. Virus removal is a very high-demand service offered by many computer repair shops. Even the Mac OS is more open to attack these days.

Linux isn't targeted nearly as much as Windows. Of course, Linux can still be vulnerable to attack. As secure as Linux distributions are, anti-virus protection is still warranted.

If it's not already installed, there is a free program called *ClamTk* available to download from the Software Center (Figure 10-15).

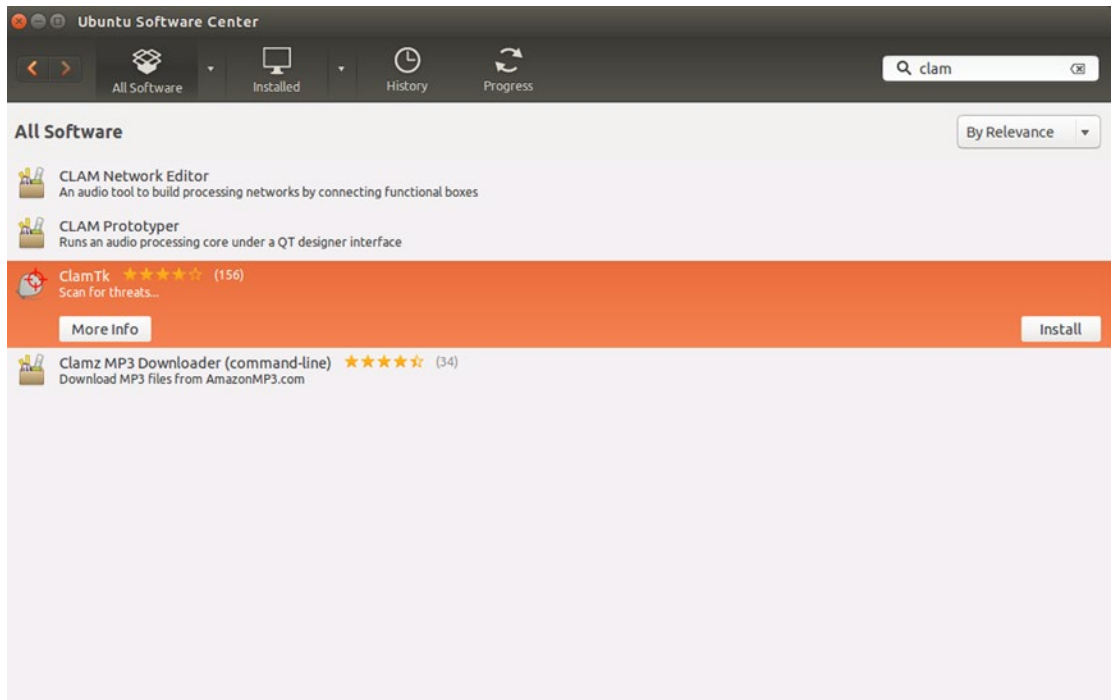

**Figure 10-15.** *ClamTk* is available to download from the Software Center

The interface is basic and straightforward (Figure 10-16); you can download updates, schedule specific times for the software to run, scan files and directories, etc.

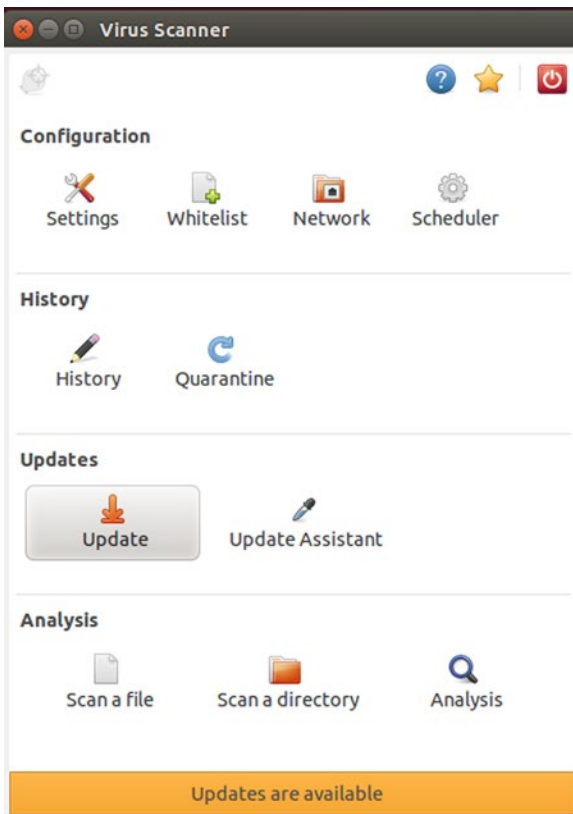

**Figure 10-16.** The ClamTk interface is basic and straightforward

## Accessory Compatibility

Ubuntu 14.04 is highly compatible with most devices, such as routers, printers, wireless Wi-Fi adapters, and cameras. The list goes on. If it has a USB connection, Ubuntu will most likely detect it (Figure 10-17).



**Figure 10-17.** Ubuntu is very compatible with most accessories and devices

■ **Note** Ubuntu can detect some older devices that Windows might not. For example, Ubuntu can detect my old 2005 model Canon Digital Rebel, but my Windows 7 system does not recognize it at all.

## Ubuntu Support

Ubuntu is an easy-to-use operating system. If you are proficient using Windows or Mac, Ubuntu will be somewhat different, but most people can come to grips with it quickly. There are plenty of avenues to pursue for support when it's needed. Ubuntu has a strong user base and a very helpful community. The Ask Ubuntu section of the website (<https://askubuntu.com/>) is a great starting point (Figure 10-18). YouTube hosts a plethora of introductory and instructional videos covering Ubuntu.

**Figure 10-18.** The Ask Ubuntu section of the website offers a great deal of support

Canonical ([www.canonical.com](http://www.canonical.com)) is the company behind Ubuntu. Canonical's flagship service, Ubuntu Advantage, offers paid support to enterprises and businesses that use Ubuntu's desktop OS, server, and cloud. Canonical's website states that it serves enterprises both large and small.

## Zorin OS: Especially for Newcomers to Linux

Zorin OS (now in version 9) is another Linux distribution worth investigating. It's primarily designed for newcomers to Linux, especially those accustomed to working in a Windows environment. Zorin OS is based on Ubuntu, but it has its own developers, support, and community. The official Zorin OS website is <http://zorin-os.com/index.html>.

Zorin OS comes in several versions, four of them are free and two are paid premium versions. All versions have WINE preinstalled to run many legacy Windows applications.

- **Zorin 9 OS Core (32- or 64-bit):** This general-purpose version provides all of the essential functions and software most users would need (comparable to Ubuntu).
- **Zorin 9 OS Educational (32- or 64-bit):** This version is geared toward use in schools, colleges, and other educational institutions. It comes with learning applications for science, math, geography, and languages.
- **Zorin 9 OS Lite (32-bit only):** This version is designed for older, lower spec computers. It provides the essentials needed for web browsing, creating documents, viewing photos, and other functions without the heavier applications.
- **Zorin 9 OS Lite Educational (32-bit only):** This version is the Lite version of Zorin OS, plus the educational programs.
- **Zorin 9 OS Ultimate (32- or 64-bit):** This is a paid version of Zorin OS that includes all of the software that comes with the free version, but also includes extra software for gaming and multimedia.
- **Zorin 9 OS Business (32- or 64-bit):** This is a paid version Zorin OS geared for business use. It also has all of the software included in the free version, but includes a variety of applications for accounting and bookkeeping, stock analysis, database, retail, word processing, and spreadsheets, among others.

Like Ubuntu 14.04, all of the Zorin 9 OS editions receive long-term support in the form of regular software updates and security updates until 2019. Technical support is offered for the paid editions of Zorin OS.

## The Look Changer

The *Look Changer* allows Zorin OS to emulate the look of Windows (or Mac OS X, in some editions), providing the user with a familiar desktop environment. Figure 10-19 displays the options for changing the look to Windows 7, Windows XP, or GNOME 2.

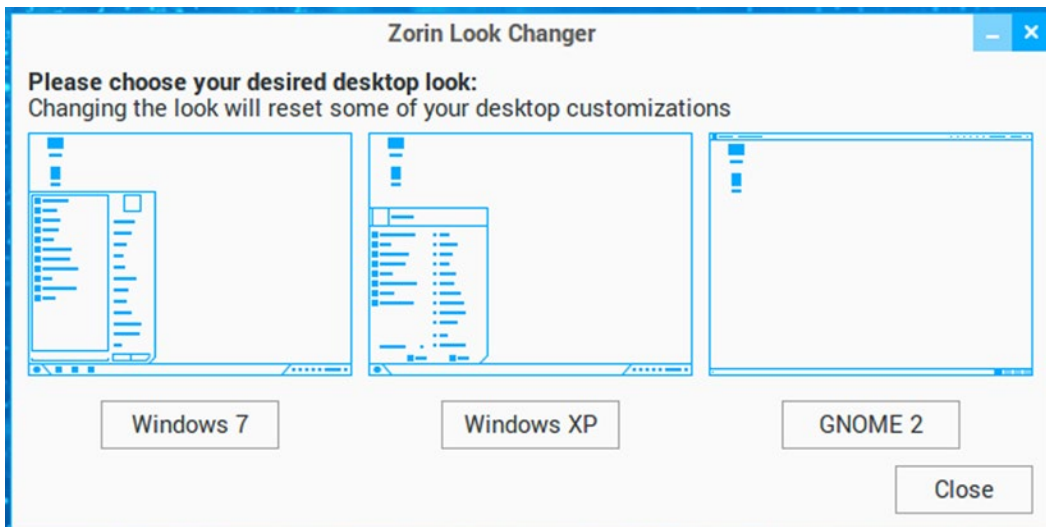

**Figure 10-19.** The Zorin Look Changer (Used with permission © The Zorin OS Team 2015)

■ **Note** In the Lite Editions of Zorin OS, the Look Changer offers a choice of changing the look to resemble either Mac OS X or Windows 2000. The Premium editions offer additional options to give the Zorin OS a different look.

In the Windows 7 mode, the menu shown in Figure 10-20 bears a resemblance to the Windows 7 Start Menu.

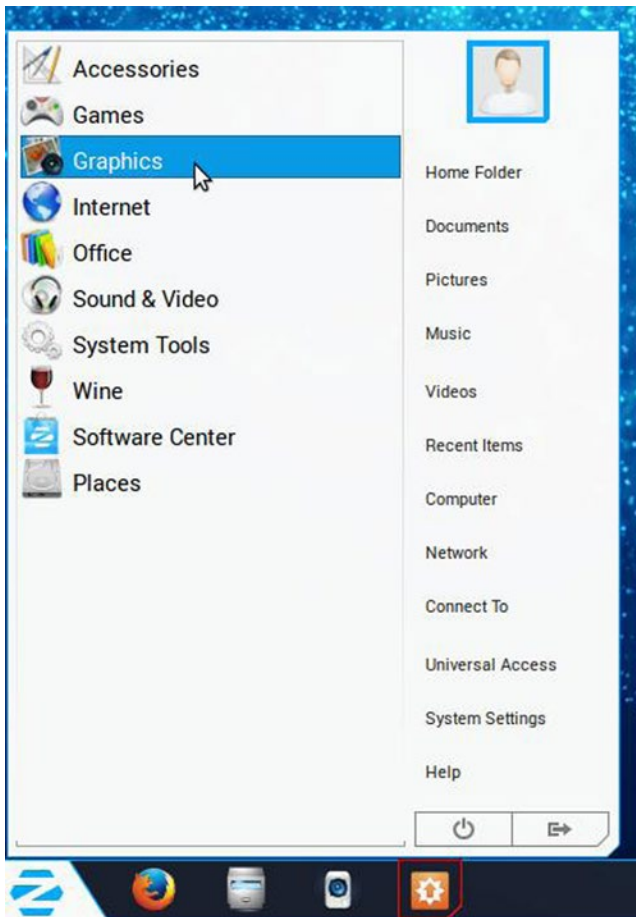

**Figure 10-20.** The Zorin OS Look Changer Windows 7 mode (Used with permission © The Zorin OS Team 2015)

## Downloading and Installing Zorin OS

The process for acquiring and installing the Zorin OS of your choice is done in essentially the same manner as Ubuntu. The premium versions must be purchased before they can be downloaded. Once downloaded, the ISO image is burned to a DVD. Click the *Get it* link to download the version of your choice (Figure 10-21). The Installation Guide can be found at <http://zorin-os.com/installguide.html>.

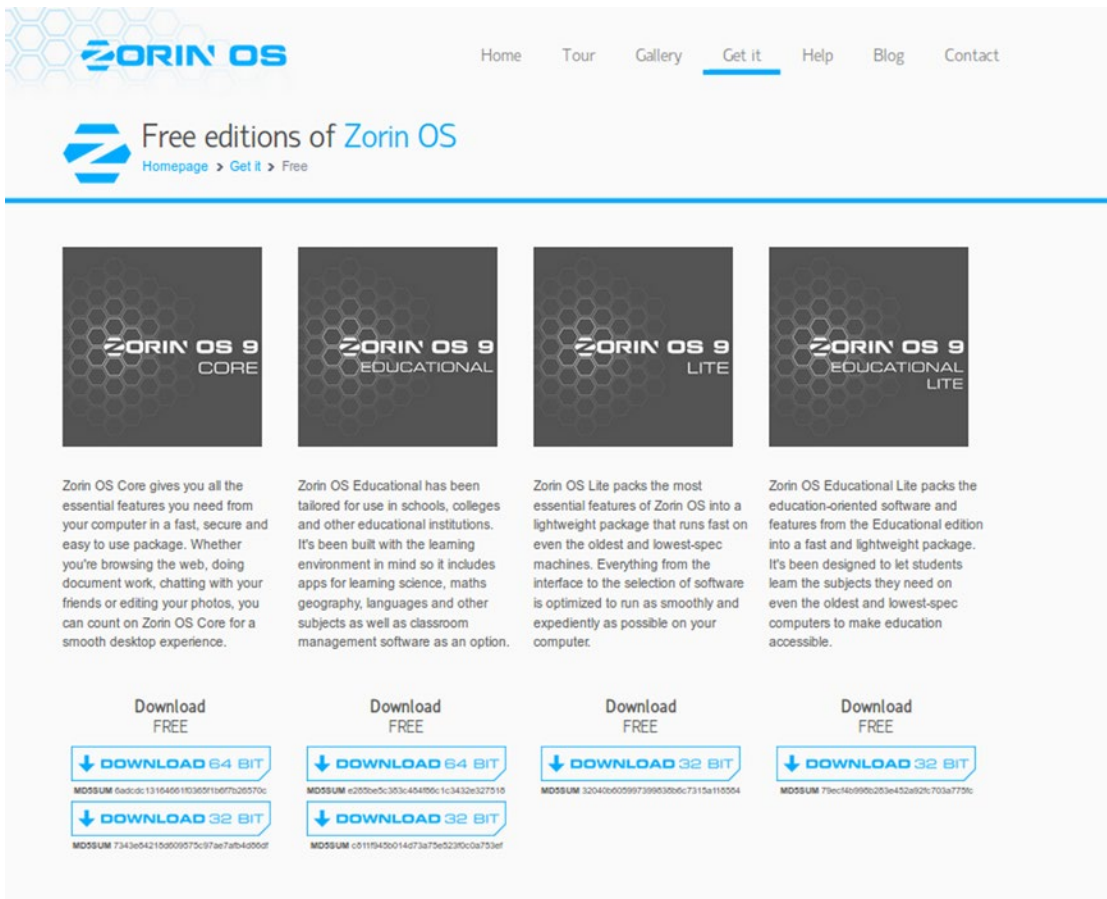

**Figure 10-21.** The downloads page for the free editions of Zorin OS (Used with permission © The Zorin OS Team 2015)

■ **Note** If you've already installed Ubuntu, you can try Zorin OS from the live DVD. If you like Zorin OS but don't want to remove Ubuntu, it can be installed alongside Ubuntu.

If you'd like to download a paid version (Figure 10-22), click the version of your choice. Zorin OS 9 Ultimate is 9.99 Eur (about 11.14 USD). Zorin OS 9 Business is 8.99 Eur (about 10.02 USD). You'll be directed to PayPal to make your payment.

Home Tour Gallery **Get it** Help Blog Contact

**ZORIN OS**

Premium editions of Zorin OS  
[Homepage](#) > [Get it](#) > Premium

If you wish to support our project you can donate here and you will get technical support and a Premium version of Zorin OS.  
 Please try Zorin OS Core before purchasing a Premium edition to make sure that your computer is compatible with it.



Zorin OS 9 Ultimate lets you unleash the full potential of your computer. If you're into business, multimedia or gaming you can rely on the vast array of software in Zorin OS Ultimate to get what you need done, or just to have fun. Our premium software as well as all applications from Zorin OS Core are also included.

Download  
€999

[↓ DOWNLOAD 64 BIT](#)

[↓ DOWNLOAD 32 BIT](#)



Zorin OS 9 Business provides all the tools needed to run your business. In here you will find a wealth of software including apps for accounting, bookkeeping, stock analysis, database, retail, word processing, spreadsheets and much more. Our premium software as well as all applications from Zorin OS Core are also included.

Download  
€899

[↓ DOWNLOAD 64 BIT](#)

[↓ DOWNLOAD 32 BIT](#)

**Figure 10-22.** The downloads page for the paid premium editions of Zorin OS (Used with permission © The Zorin OS Team 2015)

## Zorin OS Support

If you downloaded a premium edition, then technical support is available. For the free editions, the *Help* page offers a great deal of information. The best place to start if you run into trouble is the *FAQ* page (Figure 10-23), which addresses the most common issues; also, the Forum and Blog are useful resources. As always, YouTube has numerous overview and instructional videos covering every edition of Zorin OS.

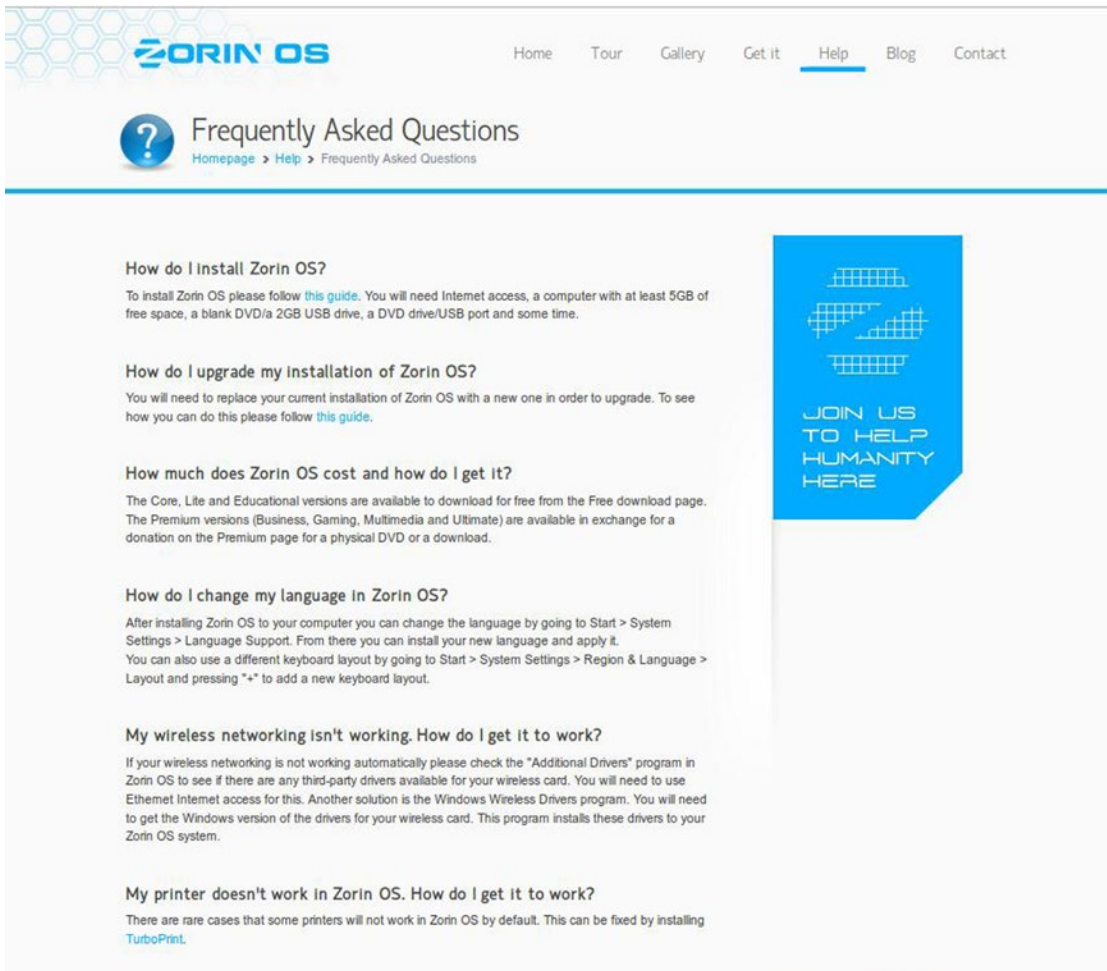

**Figure 10-23.** The FAQ page on the Zorin OS website is a good place to start if you encounter problems. (Used with permission © The Zorin OS Team 2015)

## Linux Mint: A Modern, Elegant Operating System

Linux Mint is ostensibly the third largest desktop operation system after Windows and Mac in terms of user base. This distribution designed to be clean, modern, and easy to use. There are actually several versions of Linux Mint, each sporting a different desktop environment based on either Ubuntu or Debian. Figure 10-24 displays the Cinnamon version of the desktop.



**Figure 10-24.** *The Linux Mint desktop has a clean, sleek look. (Used with permission © Clement Lefebvre, Project Leader Linux Mint 2015)*

Linux Mint is aimed primarily at home users, but it can be used in a business environment. Like Ubuntu and Zorin OS, there is long-term support for Linux Mint. Applications are launched from the pop-up Menu button (Figure 10-25) on the task bar located on the lower left corner of the screen.

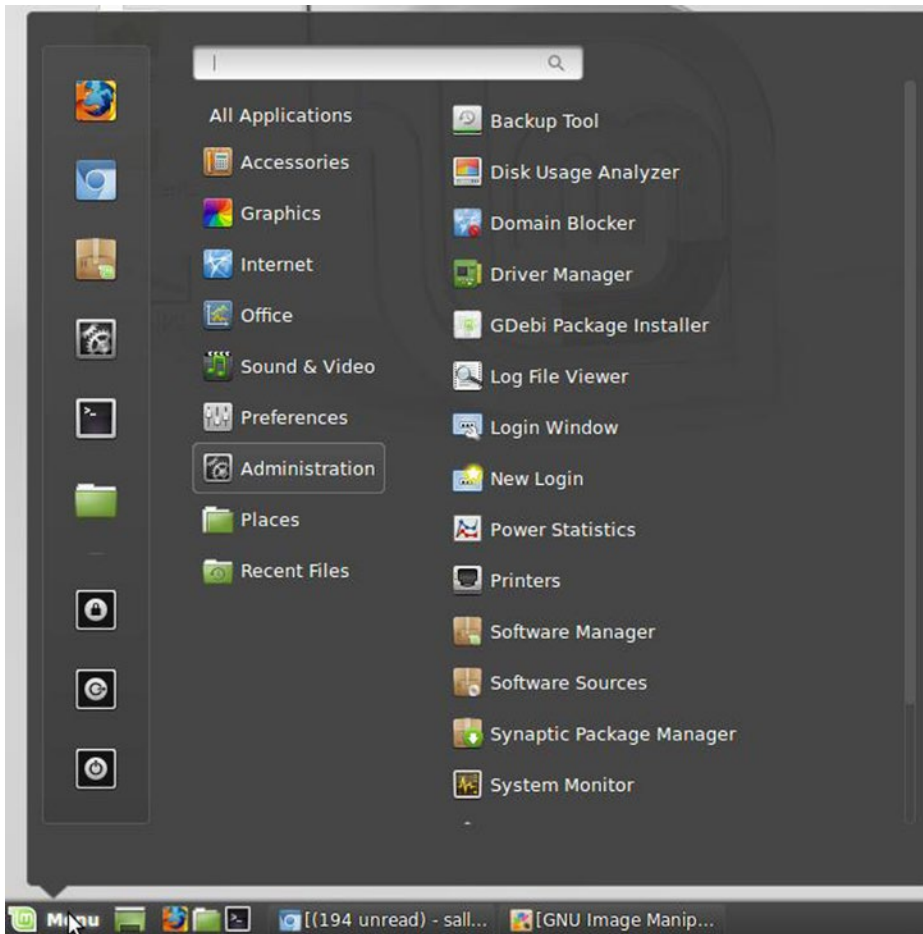

**Figure 10-25.** Applications are launched from the Menu.

---

■ **Note** Part of Linux Mint’s appeal is the resemblance of the application launch menu to the Start menu used on Windows. Like Zorin OS, this helps provide a familiar environment for Linux newcomers.

---

Like other Linux distributions, Mint comes preloaded with software packages for viewing photos, creating documents, etc. Additional software can be acquired from Mint’s software repositories by launching the *Software Manager* (Figure 10-26). The menu displays a list of software categories to help you narrow down your search. Using the keyword search feature will pull up a list of the applications that best match your request.



**Figure 10-26.** Additional software applications are available from the Software Manager

## Downloading and Installing Linux Mint

The Linux Mint ISO installer can be downloaded from the official website. There will be several versions to choose from, both in 32- or 64-bit (Figure 10-27).

[Read the Linux Mint User Guide](#)   
[Read the release notes](#)

Choose your favorite edition below. If you're not sure which one is right for you, "Cinnamon 64-bit edition" is the most popular.

### Download links

		EDITION	MULTIMEDIA SUPPORT *
Cinnamon	<a href="#">32-bit</a> <a href="#">64-bit</a>	An edition featuring the <a href="#">Cinnamon</a> desktop	Yes
Cinnamon No codecs	<a href="#">32-bit</a> <a href="#">64-bit</a>	A version without multimedia support. For magazines, companies and distributors in the USA, Japan and countries where the legislation allows patents to apply to software and distribution of restricted technologies may require the acquisition of 3rd party licenses*.	No
Cinnamon OEM	<a href="#">64-bit</a>	An installation image for manufacturers to pre-install Linux Mint.	No
MATE	<a href="#">32-bit</a> <a href="#">64-bit</a>	An edition featuring the <a href="#">MATE</a> desktop	Yes
MATE No codecs	<a href="#">32-bit</a> <a href="#">64-bit</a>	A version without multimedia support. For magazines, companies and distributors in the USA, Japan and countries where the legislation allows patents to apply to software and distribution of restricted technologies may require the acquisition of 3rd party licenses*.	No
MATE OEM	<a href="#">64-bit</a>	An installation image for manufacturers to pre-install Linux Mint.	No
KDE	<a href="#">32-bit</a> <a href="#">64-bit</a>	An edition featuring the <a href="#">KDE</a> desktop	Yes
Xfce	<a href="#">32-bit</a> <a href="#">64-bit</a>	An edition featuring the <a href="#">Xfce</a> desktop	Yes

\* Missing codecs and extra applications can be installed with a simple click of the mouse.

**Figure 10-27.** The download links on the Linux Mint website (Used with permission © Clement Lefebvre, Project Leader Linux Mint 2015)

If you don't have access to a broadband internet connection, an installation DVD can be purchased for a nominal fee from OSDisc.com. This provider sells installation discs for other Linux distributions as well. To order a disc, click the *Buy CDs* tab on the website, or go to [www.osdisc.com/products/linux/linuxmint?affiliate=linuxmint](http://www.osdisc.com/products/linux/linuxmint?affiliate=linuxmint).

---

■ **Note** It's suggested in the *Linux Mint User Guide* that if you're unsure which edition to download, the MATE version is the best choice since it offers the greatest hardware compatibility.

---

## Linux Mint Support

The comprehensive *Linux Mint User Guide* is available in multiple languages as a PDF download under the *Documentation* tab (Figure 10-28) on the website. After a brief introduction, it guides the reader in the installation process, getting to know the desktop environment, and managing software.

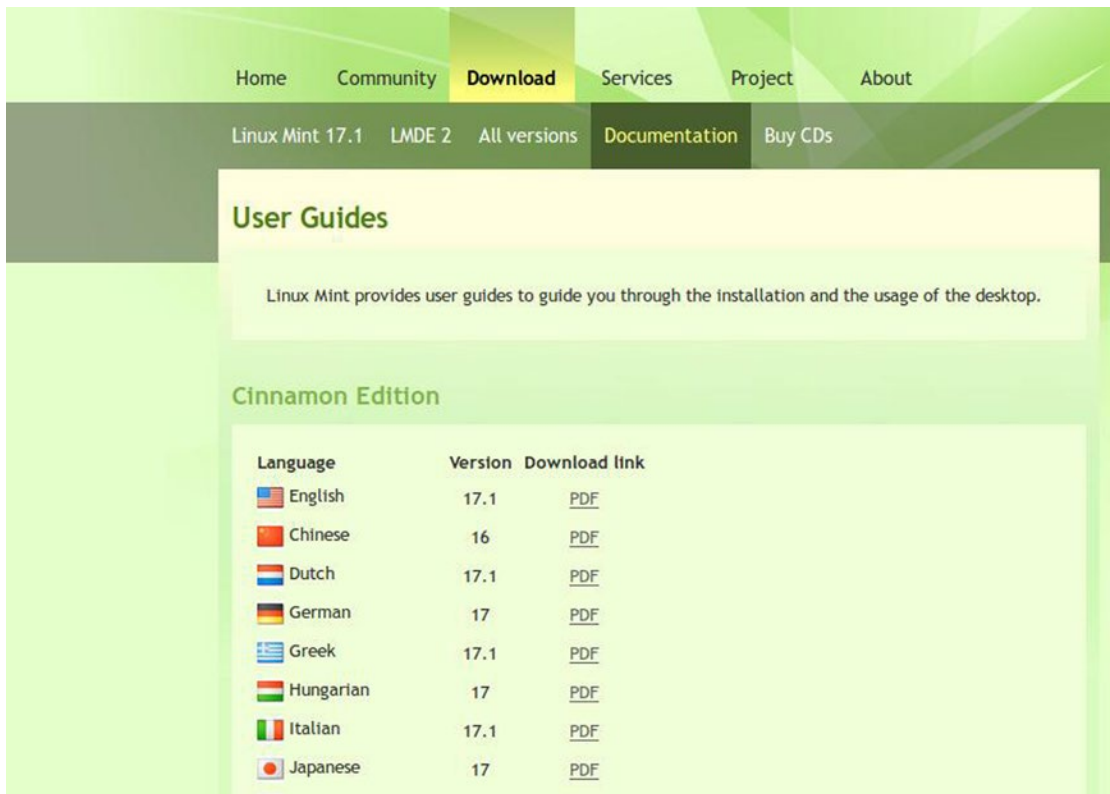

**Figure 10-28.** The User Guide is available in multiple languages (Used with permission © Clement Lefebvre, Project Leader Linux Mint 2015)

Because Linux Mint is so popular, there's an abundance of help available; click the *Community* tab to access the forum, blog, and other avenues of information. YouTube hosts plenty of videos pertaining to Linux Mint, including overviews, comparisons of the different versions, and instructional tutorials.

## Summary

In this chapter, you learned about the Linux kernel and the various Linux distributions that abound. You learned a little about the origins of Linux, and its progression from a system requiring the skills of a computer programmer to use into the easy-to-use distributions available today.

Linux offers several notable advantages; it's free to download (in most cases), it can be tried out before installing, it comes preloaded with lots of software—the list goes on.

You looked at three distributions: Ubuntu, Zorin OS, and Linux Mint. While they are all the same on a core level, each distribution has unique features built into it. Ubuntu is a very popular distribution around the world, with device compatibility being one of its strongest points. Zorin OS is designed to help transition newcomers accustomed to working in the Windows environment into a Linux environment. Linux Mint is a popular distribution with a clean, modern look.

For those who embrace using a Linux distribution as their OS of choice, it's worth considering giving back to the Linux community in some way, from financial donations to lending expertise on help forums.

## APPENDIX A



# Professional Profiles

## Patrick David

Pat David (Figure A-1) is a talented photographer as well as a free and open source software advocate. He can do incredible things with photographic images using the *GNU Image Manipulation Program* (or GIMP), G'MIC (a plug-in utility containing of a wide variety of filter effects for GIMP), and other open source photography software.



**Figure A-1.** *Pat David creates incredible photographic images using open source software. (Used with permission © Patrick David 2015)*

Mr. David is very active in his advocacy for GIMP. When asked about the advantages of working with free and open source software, his response was this: “The main advantage of F/OSS to me is the community and communication directly with the developers of the tools I use. I’ve been able to build friendships with the project developers and have been lucky enough to get some ideas integrated into the software. Everyone has been fantastic in the communities to learn from and it’s very rewarding to help others realize what they can accomplish using free software!”

Mr. David runs an open source photography site called PIXLS.US (<https://pixls.us/>). There is a Blog section that highlights upcoming ideas for articles, what's happening in the world of photography, and similar topics. The Articles section (Figure A-2) is an excellent source of “how to” information on image editing using GIMP and other open source software programs. The Discuss section is a forum to connect with others in the open source photography community.

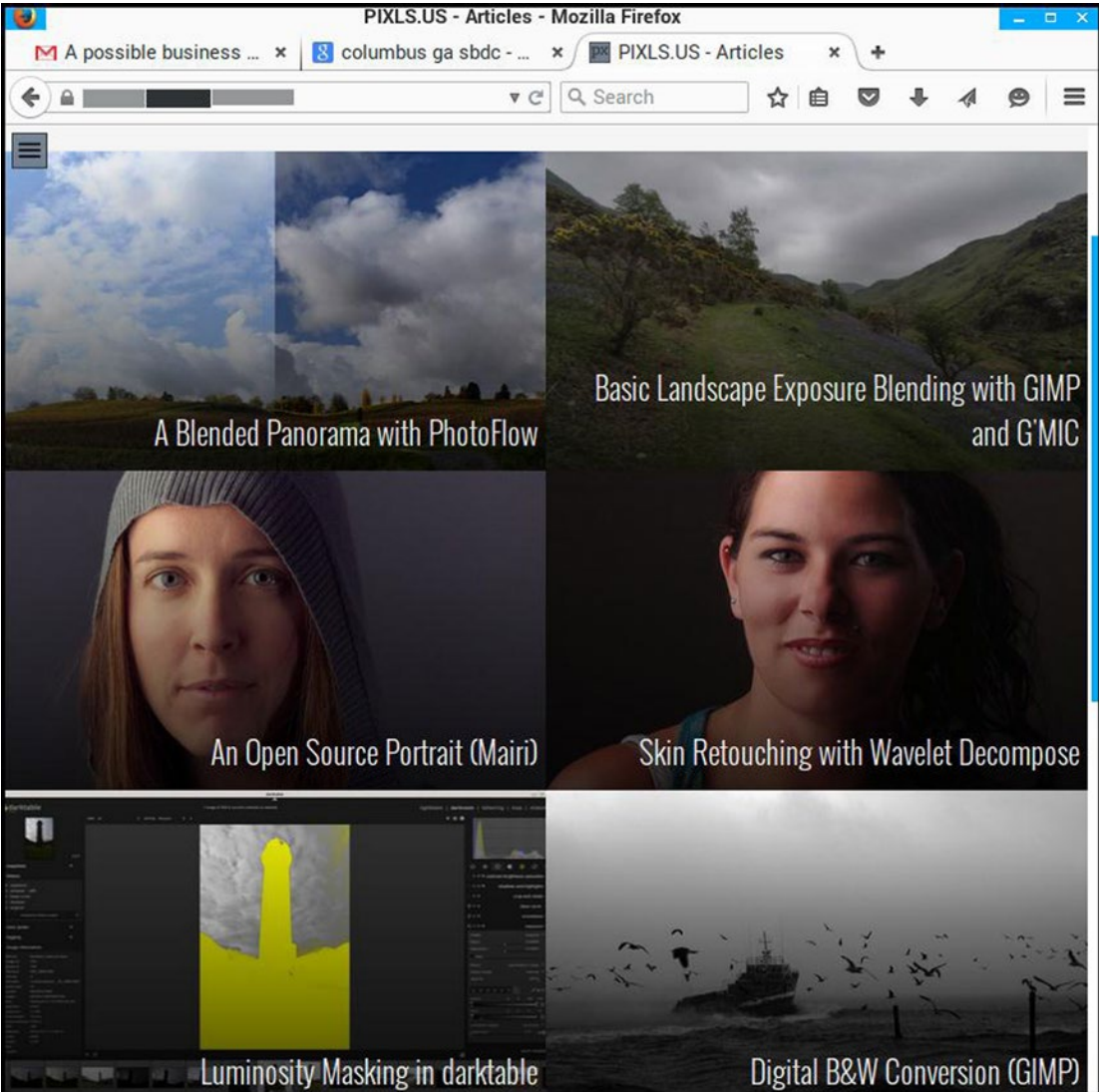

**Figure A-2.** PIXLS.US is a great learning resource for open source photography techniques. (Used with permission © Patrick David 2015)

## Steve Czajka

Steve Czajka (Figure A-3) is another talented individual who harnesses the power of free and open source software. Mr. Czajka is the owner of Steve Czajka Calligraphy and the publisher of *GIMP Magazine*.



**Figure A-3.** Steve Czajka is the owner of Steve Czajka Calligraphy and the publisher of *GIMP Magazine*. (Used with permission © Steve Czajka 2015)

In addition to utilizing programs like GIMP, he also uses open source programs such as Scribus and Inkscape in the creation of his various works, including *GIMP Magazine* (Figure A-4). Mr. Czajka uses open source software for reasons similar to those of Patrick David. When asked about the advantages of open source software, his response was this: “I use open source software as it generally meets all of my needs. I also use it as I find the general performance is better than most commercial grade applications. And finally I use open source software so that I can share my experience back to the existing open source community of users and people who may be considering using open source software.”



**Figure A-4.** Steve Czajka uses open-source software such as GIMP, Inkscape, and Scribus in his work. (Used with permission© Steve Czajka 2015)

Mr. Czajka has been a graphic designer since the mid-1980s. With the aid of open source design software, he is capable of creating stunning greeting cards (Figure A-5). His work is proof that open source solutions are capable of producing high quality, professional results that often rival those produced by proprietary software.



**Figure A-5.** Steve Czajka produces stunning work using open source design software. (Used with permission © Steve Czajka 2015)

In addition to his aforementioned activities, Mr. also offers digital video courses in beginner and advanced calligraphy, desktop publishing using Scribus, and illustration using Inkscape. For more details, go to [www.gimpmagazine.org](http://www.gimpmagazine.org) and download a free copy of the latest issue of *GIMP Magazine*.

## APPENDIX B



# Additional Software Products

It's certainly my hope that you found the software solutions you were looking for in the main portion of this book. However, as I did my research for this book, more options were brought to my attention. This appendix covers a supplemental list of free software solutions that you may find useful.

## Office Productivity, Note Taking, Accounting, and PDF Creation

Here are several software products related to office work similar to the ones in Chapter 1.

### Jarte

- **Software description (as shown on the provider's website):** A free word processor based on the Microsoft WordPad word processing engine built into Windows. A fast-starting, easy-to-use word processor that expands well beyond the WordPad feature set. A small, portable, touch-enabled word processor whose documents are fully compatible with Word and WordPad (There are paid versions of Jarte available that offer more features).
- **Website:** [www.jarte.com/features.html](http://www.jarte.com/features.html)
- **License:** Proprietary Freeware
- **Current Version:** 5.3
- **Operating System(s):** Windows

### NeoOffice

- **Software description (as shown on the provider's website):** NeoOffice is a complete office suite for Mac OS X. With NeoOffice, users can view, edit, and save OpenOffice documents, LibreOffice documents, and simple Microsoft Word, Excel, and PowerPoint documents.
- **Website:** [www.neooffice.org/neojava/en/index.php](http://www.neooffice.org/neojava/en/index.php)
- **License:** GPL
- **Current Version:** 2014.12 (Free Edition)
- **Operating System(s):** Mac OS

## KeepNote

- **Software description (as shown on the provider's website):** KeepNote is a note-taking application that works on Windows, Linux, and Mac OS X. With KeepNote, you can store your class notes, TODO lists, research notes, journal entries, paper outlines, etc. in a simple notebook hierarchy with rich-text formatting, images, and more. Using full-text search, you can retrieve any note for later reference.
- **Website:** <http://keepnote.org/>
- **License:** GPL
- **Current Version:** 0.7.8
- **Operating System(s):** Windows, Mac OS, Linux

## RedNotebook

- **Software description (as shown on the provider's website):** RedNotebook is a modern journal. It includes calendar navigation, customizable templates, export functionality, and word clouds. You can also format, tag, and search your entries. RedNotebook is Free Software under the GPL.
- **Website:** <http://rednotebook.sourceforge.net/index.html>
- **License:** GPL
- **Current Version:** 1.10.1
- **Operating System(s):** Windows, Mac OS, Linux

## TurboCASH

- **Software description (as shown on the provider's website):** *TurboCASH* Accounting is a community-developed, top-drawer, SME accounting package that will make your business competitive. Here is a world class software package that is going to improve your profitability. Best of all, it is free. There are no catches here. We are not looking to become your "accounting department." It is our pleasure to watch you make profit. As a community member, we want you to use *TurboCASH*- **FREE**.
- **Website:** [www.turbocash.net/index.php](http://www.turbocash.net/index.php)
- **License:** GPL
- **Current Version:** 5.00600
- **Operating System(s):** Windows, Mac OS, Linux

## Buddi

- **Software description (as shown on the provider’s website):** Buddi is a personal finance and budgeting program, aimed at those who have little or no financial background. In making this software, I have attempted to make things as simple as possible, while still retaining enough functions to satisfy most home users.
- **Website:** <http://buddi.digitalcave.ca/>
- **License:** GPL
- **Current Version:** 3.1.4.13
- **Operating System(s):** Windows, Mac OS, Linux

## CutePDF Writer

- **Software provider’s description:** Portable Document Format (PDF) is the de facto standard for the secure and reliable distribution and exchange of electronic documents and forms around the world. CutePDF Writer is the free version of commercial PDF converter software. CutePDF Writer installs itself as a “printer subsystem.” This enables virtually any Windows applications (must be able to print) to convert to professional quality PDF documents - with just a push of a button!
- **Website:** [www.cutepdf.com/Products/CutePDF/writer.asp](http://www.cutepdf.com/Products/CutePDF/writer.asp)
- **License:** Proprietary Freeware
- **Current Version:** 3.0
- **Operating System(s):** Windows

## Point of Sale, CRM, Backup, and Compression Software

### Regit<sup>®</sup> Express Point of Sale for Windows

- **Software provider’s description:** American Precision Instruments has been providing merchants all over the world with powerful, proven, and affordable POS software since we first released Regit POS in 1984. Now American Precision Instrument has released Regit Express, a free, powerful point-of-sale system with a wide range of features that will meet the needs of many retail merchants.
- **Website:** [www.free-pos-software.com/](http://www.free-pos-software.com/)
- **License:** Proprietary Freeware
- **Current Version:** 4.0.1.7
- **Operating System(s):** Windows (the .NET Framework 4.0 must be installed, freely available from Microsoft)

## SuiteCRM

- **Software provider's description:** SuiteCRM is a free and open source alternative to Salesforce, Dynamics, and other proprietary software. Feature-rich, powerful, flexible, and user-friendly, it is one of the most popular CRM applications globally.
- **Website:** <https://suitecrm.com/>
- **License:** AGPL
- **Current Version:** 7.2.2
- **Operating System(s):** Windows, Mac OS, Linux

## Areca Backup

- **Software provider's description:** It basically allows you to select a set of files/directories to back up, choose where and how (as a simple file copy, as a zip archive, ...) they will be stored, and configure post-backup actions (like sending backup reports by email or launching custom shell scripts).
- **Website:** [www.areca-backup.org/](http://www.areca-backup.org/)
- **License:** GPL V2
- **Current Version:** 7.2.2
- **Operating System(s):** Windows, Linux

## PeaZip

- **Software provider's description:** PeaZip is freeware file archiver software, providing a wide array of file management tools, and it is released under Open Source license LGPLv3, which means this application is free of charge for any use (personal and professional, business and government, etc...), modification, and distribution.
- **Website:** <http://peazip.sourceforge.net/>
- **License:** LGPL V3
- **Current Version:** 5.6.1
- **Operating System(s):** Windows, Linux

## Illustration, Painting, 3D Modeling Software, and Photo Editing

Here are several software products similar to the ones in Chapters 3 and 4.

### Draw SVG

- **Software provider's description:** The free online drawing application for designers and developers, Draw SVG is fully standard compliant SVG.
- **Website:** [www.drawsvg.org/](http://www.drawsvg.org/)
- **License:** Proprietary Freeware
- **Current Version:** 4-1
- **Operating System(s):** Browser-based

### Sumo Paint

- **Software provider's description:** Sumo Paint is an online image editor; there's no need to install anything to your device. It's the most versatile photo editor and painting application that works in a browser. You can open and save images from your hard drive or save them to the cloud.
- **Website:** [www.sumopaint.com/home/](http://www.sumopaint.com/home/)
- **License:** Proprietary Freeware
- **Current Version:** 8.31
- **Operating System(s):** Browser-based

### K-3D

- **Software provider's description:** K-3D is free-as-in-freedom 3D modeling and animation software. It combines flexible plug-ins with a visualization pipeline architecture, making K-3D a versatile and powerful tool for artists.
- **Website:** [www.k-3d.org/node/1](http://www.k-3d.org/node/1)
- **License:** GPL
- **Current Version:** 8.0.1
- **Operating System(s):** Windows, Mac OS

### Photo POS

- **Software provider's description:** Photo POS Pro Photo Editor is a free photo editor that offers users a wide variety of possibilities in the fields of image enhancing, image editing, and computer graphics design. Using the editor you can perform various tasks, from simple basic tasks to complex tasks; you can edit existing images, create new works based on existing images, create new works from scratch, and more.
- **Website:** [www.free-photo-editor.net/](http://www.free-photo-editor.net/)

- **License:** Proprietary Freeware
- **Current Version:** 1.90.5
- **Operating System(s):** Windows

## Darktable

- **Software provider's description:** Darktable is an open source photography workflow application and RAW developer, a virtual light table and darkroom for photographers. It manages your digital negatives in a database, lets you view them through a zoomable light table, and enables you to develop raw images and enhance them.
- **Website:** [www.darktable.org/](http://www.darktable.org/)
- **License:** GPL V3
- **Current Version:** 1.6.7
- **Operating System(s):** Mac OS, Linux

## Audio-Video Software

Here are a couple of software products similar to some of the ones seen in Chapters 5.

### Audiograbber

- **Software provider's description:** Audiograbber is a beautiful piece of software that grabs digital audio from CDs. Audiograbber can automatically normalize the music, delete silence from the start and/or end of tracks, and encode them to a variety of formats including MP3. Audiograbber can download and upload disc info from freedb, an Internet compact disc database. You can even record your vinyl LPs or cassette tapes with Audiograbber and make WAVs or MP3s of them. There are a lot more functions in Audiograbber, but to put it simply: Audiograbber has the most features one can wish from such a program!
- **Website:** [www.audiograbber.org/](http://www.audiograbber.org/)
- **License:** Proprietary Freeware
- **Current Version:** 1.83
- **Operating System(s):** Windows

## Avidemux

- **Software provider's description:** Avidemux is a free video editor designed for simple cutting, filtering, and encoding tasks. It supports many file types, including AVI, DVD compatible MPEG files, MP4, and ASF, using a variety of codecs. Tasks can be automated using projects, job queues, and powerful scripting capabilities.
- **Website:** <http://fixounet.free.fr/avidemux/>
- **License:** GPL
- **Current Version:** 1.83
- **Operating System(s):** Windows , Mac OS, Linux

## Project Management

There are two project management solutions listed in Chapter 6, but for good measure here's one more.

## Redmine

- **Software provider's description:** Redmine is a flexible project management web application. Written using the Ruby on Rails framework, it is cross-platform and cross-database. Redmine is open source and released under the terms of the GNU General Public License v2 (GPL).
- **Website:** [www.redmine.org/](http://www.redmine.org/)
- **License:** GPL
- **Current Version:** 3.0.4
- **Operating System(s):** Redmine should run on most Unix, Linux, Mac, Mac Server, and Windows systems as long as Ruby is available on the platform.

## APPENDIX C



# Resources for Free and Open Source Software

- Free Software Foundation  
[www.fsf.org/about](http://www.fsf.org/about)
- GNU Operating System  
[www.gnu.org/](http://www.gnu.org/)
- It's F.O.S.S.  
<http://itsfoss.com/>
- The Document Foundation (The Home of LibreOffice)  
[www.documentfoundation.org](http://www.documentfoundation.org)
- The Linux Foundation  
[www.linuxfoundation.org](http://www.linuxfoundation.org)
- BeginLinux.com (Linux Training Courses)  
<http://beginlinux.org>
- Open Source Business Plans  
[www.open-bp.com/site\\_open\\_bp](http://www.open-bp.com/site_open_bp)
- Open Source for You  
<http://opensourceforu.ifytimes.com>
- The Open Source Initiative  
<http://opensource.org/about>
- Open of Course - Free and Open Content Courses and Tutorials  
[www.open-of-course.org/courses/](http://www.open-of-course.org/courses/)
- Open Source Training  
[www.opensourcetraining.co.uk](http://www.opensourcetraining.co.uk)
- SourceForge (For finding and publishing open source software)  
<http://sourceforge.net/>

# Index

## ■ A

### AbiWord

- word processing, 2
  - business letter template, 3
  - features, 3
  - program's functions, 4
  - user's manual, 4

### Areca Backup, 238

### Audacity

- click tracks, 125
- definition, 122
- effects menu, 125
- features, 123
- old radio ad spots digitization, 123
- record button, 124
- user manual, 126

### Audio CD Ripping program. *See* Free audio conter (fre:ac) program

### Audiograbber, 240

### Avidemux, 241

### Avira antivirus

- advantages, 196
- definition, 195
- degree of protection, 195
- features, 196
- support, 196

## ■ B

### BlueGriffon

- Community page, 177
- CSS files, 177
- definition, 175
- Document type wizard, 175–176
- KompoZer, 176
- restore last session's tabs, 177

### Buddi software, 237

### Business Accounting Software. *See* Manager software

## ■ C

### Chromium, 177–178

### ClamAV antivirus

- definition, 196
- features, 197
- server-side email virus scanner, 196–197
- support, 198

### Content Management Solutions (CMS)

#### concrete5

- definition, 183
- ease of use, 183–184
- features, 183
- Free Help page, 185–186
- themes, 184–185

#### Drupal

- backend framework, 181
- “bug bounty” program, 182–183
- definition, 181
- features, 182
- principles, 181

#### GetSimple CMS

- configuration, 187
- custom themes creation, 187–188
- definition, 186
- features, 186
- support, 188

### Customer relationship management (CRM)

- systems, 31

#### Bitrx24

- calender, 46
- definition, 43
- features, 43
- My Drive, 47
- social media platform, 44–45
- Support24, 47–48

#### Insightly

- customer information, 41
- features, 40
- free version, 39

## ■ INDEX

Customer relationship management (CRM)  
  systems (*cont.*)  
  implementation, 40  
  project management, 41–42  
  University, 42

CutePDF Writer, 237

## ■ D, E

Darktable, 240

Desktop Publishing Program

  Scribus

    definition, 63

    features, 64

    pamphlet I design, 63

    sign templates, 65

    text/image frames, 64

    user manual,

      official website, 65

  Serif PagePlus Starter Edition

    definition, 60

    features, 60

    image selection, 61–62

    support, 62

    theme layouts, 60–61

Draw SVG, 239

## ■ F

File Backup/Compression Solutions

  7Zip

    Add to archive option, 54–56

    features, 53

    layered GIMP files, 53

    process involved, 52

    support page, 56–57

  FBackup

    backup performance, 52

    definition, 48

    features, 49

    file navigation, 50

    Getting Started menu, 49

    Help tab, 52

    local drive, data storage, 51

    manual control, 52

Firefox

  advantages, 179

  “bug bounty”, 180

  definition, 178

  disadvantages, 179

  vulnerabilities, 180

FotoSketcher

  artistic filter, 115–116

  features, 114

  oil paint filter, 114–115

  text editor, 116–117

Free audio converter (fre:ac) program

  definition, 119

  features, 120

  LAME MP3 format, 121–122

  launching window, 120

  support, 122

  track selection/deselection, 121

Free Source Software, 35

## ■ G

GnuCash

  categories selection, 19

  features, 20

  tip of the Day, 18

  Tutorial/Concepts Guide, 20

GNU Image Manipulation Program (GIMP), 229

  customizable interface, 102

  digital retouching, 102

  file formats, 102

  GIMP Magazine, 106

  graphics creation, 105

  hardware support, 102

*Healing* tool, 102–103

*Perspective* tool, 103–104

  photo enhancement, 102

  tutorials section, 105–106

  Windows 7, 101

  YouTube, 106

Google Keep, 15–17

## ■ H

FreeHR

  definition, 153

  employee record, 155

  event notifications, 156

  FAQ page, 158

  features, 154

  performance booking, 157

## ■ I

Illustration program

  Inkscape

    camera I, 69

    definition, 68

    features, 70

    graphics creation, 70–71

  Serif DrawPlus Starter Edition, 66–67

Inventory Management, ABC Inventory

  company creation, 159

  definition, 158

- features, 159
- Inventory Item Master List, 160–161
- menus navigation, 161–162

■ **J**

Jarte, 235

■ **K**

K-3D, 239

Kdenlive

- Curves* features, 138–139
- definition, 136
- effects list, 137–138
- features, 137
- Kdenlive manual, 140–141
- video clip, timeline, 136
- video formats, 139–140

KeePass

- advantages, 193
- definition, 191
- features, 192–193
- support, 193

KeepNote, 236

KompoZer

- Add-ons, functionality, 174
- definition, 171
- features, 173
- Get Help/User Support, 175
- home page, 172

Krita

- brush presets, 75
- definition, 73
- document creation, 75
- features, 74
- tools, 73
- user manual, 77

■ **L**

LibreOffice

- Base, 5, 11
- Calc, 5, 9
- Draw, 12
- features, 5
- Impress, 5, 10
- Writer, 5, 7

Linux

- advantages, 206
- Android operating system, 201–202
- definition, 201
- history, 206
- Linux Mint

- definition, 222
- desktop, 222
- downloading and installing, 225
- launching application, 223–224
- software manager, 224–225
- support, 226–227

terminal, 204

Ubuntu (*see* Ubuntu)

Ubuntu server, 203

Zorin OS, 203–204

- downloading and installing, 219

- Look Changer, 218–219

- support, 221
- versions, 218

■ **M**

Manager software

- Backing up accounting data, 24
- business setting, 22
- customize feature, 23
- features, 21
- Forum page, 26
- guides, 25
- PDF creation, 24

Mozilla Firefox. *See* Firefox

MPEG Streamclip

- adjustments, 129
- definition, 127
- features, 128
- larger video formats, 128–129
- support, 129

■ **N, O**

NeoOffice, 235

Nmap application

- advantages, 190–191
- definition, 189
- features, 190
- security auditing, 189
- support, 191

■ **P, Q**

Paint.NET

- editing capabilities, 95
- features, 95
- graphics creation, 99–100
- interface, 94

PDF reDirect

- features, 27
- printer options, 27
- user manual, 28

PeaZip, 238

Photo editing

Autodesk Pixlr

Pixlr Editor, 107

Pixlr Express, 108–109

Pixlr O-Matic, 109–110

FotoSketcher

artistic filter, 115–116

features, 114

oil paint filter, 114–115

text editor, 116–117

GIMP (*see* GNU Image Manipulation Program (GIMP))

Paint.NET

editing capabilities, 95

features, 95

graphics creation, 99–100

interface, 94

PhotoScape

Clone Stamp tool, 89–90

desired function, 88

effect brush, 90

features, 89

filters, 90–91

Intro video, 92–93

objects, 91–92

UFRaw

Correct Luminosity/Saturation curve tool, 112–113

overexposure/

underexposure, 111–112

stand-alone application, 110

Photo POS, 239

PhotoScape

Clone Stamp tool, 89–90

desired function, 88

effect brush, 90

features, 89

filters, 90–91

Intro video, 92–93

objects, 91–92

Point-of sale solutions

Imonggo

features, 32

invoice creation, 33

office, 34

payment types, 34

product creation, 32

support team, 35

POS/cash register

definition, 35

features, 36

journal, 38

launch screen, 36

Pos Config program, 37

POS Forum, 39

Project management

Ganttter

definition, 148

features, 148

four editions, 149

Gantt chart, 152

Help page, 153

project properties, 150

task properties, 151

ProjectLibre

definition, 144

features, 144

Gantt chart, 147

new project, 145

project information, 146

tip of the day, 148

## ■ R

Redmine, 241

RedNotebook, 236

Regit® Express, 237

## ■ S

Security

Avira antivirus

advantages, 196

definition, 195

degree of protection, 195

features, 196

support, 196

ClamAV antivirus

definition, 196

features, 197

server-side email virus scanner, 196–197

support, 198

KeepPass

advantages, 193

definition, 191

features, 192–193

support, 193

Nmap application

advantages, 190–191

definition, 189

features, 190

security auditing, 189

support, 191

Open Whisper Systems, 198

tcpdump

advantages, 194

definition, 194

- features, 194
- support, 194
- SuiteCRM, 238
- Sumo Paint, 239

■ **T**

- Time tracking
  - dashboard, 166
  - definition, 162
  - features, 163
  - Getting Started menu, 167
  - Manage Client function, 163
  - Manage Project function, 164
  - project performance, 165
- TurboCASH, 236

■ **U**

- Ubuntu
  - appearance settings, 208
  - compatibility, 216
  - dashboard, 209-210
  - downloading, 210
  - installation, 210
  - security, 214
  - software center, 212
  - support, 217
  - WINE website, 214
- UFRaw
  - Correct Luminosity/Saturation curve tool, 112-113
  - overexposure/underexposure, 111-112
  - stand-alone application, 110

■ **V**

- VirtualDub
  - definition, 132
  - features, 133
  - levels filter, 133
  - logos/images, 135
  - side-by-side comparison, 134
  - support, 135

■ **W, X, Y**

- Web authoring system. *See* KompoZer
- Windows Movie Maker
  - adding titles and text, 130
  - definition, 130
  - features, 130
  - output, 131
  - resolution, 131
  - support, 132
- WordPress
  - definition, 169
  - features, 170
  - installation, 170
  - multi-user, 171
  - themes, 171

■ **Z**

- Zim
  - adding new pages and subpages, 14
  - features, 13
  - organizational tool, 13
  - text variants, 14
  - user manual, 15